

INTERNATIONAL COURT OF JUSTICE

**CASE CONCERNING
APPLICATION OF THE INTERNATIONAL CONVENTION FOR THE SUPPRESSION
OF THE FINANCING OF TERRORISM AND OF THE INTERNATIONAL CONVENTION
ON THE ELIMINATION OF ALL FORMS OF RACIAL DISCRIMINATION**

(UKRAINE V. RUSSIAN FEDERATION)

**VOLUME V OF THE ANNEXES
TO THE MEMORIAL
SUBMITTED BY UKRAINE**

12 JUNE 2018

TABLE OF CONTENTS

Annex 106	Administrative Directorate of the General Staff of the Armed Forces of Ukraine Letter No. 300/1/C/712 (13 February 2015)
Annex 107	Headquarters of the Antiterrorist Operation Letter No. 778 og (16 February 2015)
Annex 108	Administrative Directorate of the General Staff of the Armed Forces of Ukraine Letter No. 300/1/C/916 (23 February 2015)
Annex 109	Administrative Directorate of the General Staff of the Armed Forces of Ukraine Letter No. 300/1/C/1059 (27 February 2015)
Annex 110	Central Missile and Artillery Directorate Of the Armed Forces of Ukraine Letter No. 342/2/3618 (11 March 2015).
Annex 111	Administrative Directorate of the General Staff of the Armed Forces of Ukraine Letter No. 300/1/C/1451 (20 March 2015)
Annex 112	Expert Conclusion No. 557/2014, drafted by the Forensic Research Center, Ministry of Internal Affairs of Ukraine, Main Directorate of the Ministry of Internal Affairs of Ukraine in Kharkiv Region (23 March 2015)
Annex 113	Expert Opinion No. 64/1-30/6, drafted by Ukrainian Scientific Research Institute for Special Equipment and Forensic Expert Examinations, Security Service of Ukraine (26 March 2015)
Annex 114	Administrative Directorate of the General Staff of the Armed Forces of Ukraine Letter No. 300/1/C/1640 (28 March 2015)
Annex 115	Expert Opinion No. 142, drafted by the Ukrainian Scientific Research Institute of Special Equipment and Forensic Expert Examination, Security Service of Ukraine (30 March 2015)
Annex 116	Expert Conclusion No. 532/2014, drafted by the Forensic Research Center, Ministry of Internal Affairs of Ukraine, Main Directorate of the Ministry of Internal Affairs of Ukraine in Kharkiv Region (3 April 2015)
Annex 117	Expert Opinion No. 143, drafted by the Ukrainian Scientific Research Institute of Special Equipment and Forensic Expert Examination, Security Service of Ukraine (3 April 2015)
Annex 118	Expert Opinion No. 532/2014, drafted by the Forensic Research Center, Ministry of Internal Affairs of Ukraine, Main Directorate of the Ministry of Internal Affairs of Ukraine in Kharkiv Region (3 April 2015)
Annex 119	Administrative Directorate of the General Staff of the Armed Forces of Ukraine Letter No. 300/1/C/1917 (11 April 2015)
Annex 120	Administrative Directorate of the General Staff of the Armed Forces of Ukraine Letter No. 300/1/C/2056 (18 April 2015)
Annex 121	Expert Opinion No. 193/1, Ukrainian Scientific Research Institute of Special Equipment and Forensic Expert Examination of the Security Service of Ukraine (29 April 2015)

- Annex 122 Administrative Directorate of the General Staff of the Armed Forces of Ukraine Letter No. 300/1/C/2329 (2 May 2015)
- Annex 123 Expert Opinion No. 16/8, drafted by Ukrainian Scientific Research Institute for Special Equipment and Forensic Expert Examinations, Security Service of Ukraine (7 May 2015)
- Annex 124 Administrative Directorate of the General Staff of the Armed Forces of Ukraine Letter No. 300/1/C/2430 (9 May 2015)
- Annex 125 Administrative Directorate of the General Staff of the Armed Forces of Ukraine Letter No. 300/1/C/2539 (15 May 2015)
- Annex 126 Expert Opinion No. 38/6, Ukrainian Research Center for Special-Purpose Equipment and Forensic Examinations of the Security Service of Ukraine (18 May 2015)
- Annex 127 Administrative Directorate of the General Staff of the Armed Forces of Ukraine Letter No. 300/1/C/2801 (29 May 2015)
- Annex 128 Administrative Directorate of the General Staff of the Armed Forces of Ukraine Letter No. 300/1/C/2917 (5 June 2015)
- Annex 129 Administrative Directorate of the General Staff of the Armed Forces of Ukraine Letter No. 300/1/C/3068 (13 June 2015)
- Annex 130 Administrative Directorate of the General Staff of the Armed Forces of Ukraine Letter No. 300/1/C/3309 (26 June 2015)
- Annex 131 Administrative Directorate of the General Staff of the Armed Forces of Ukraine Letter No. 300/1/C/3588 (10 July 2015)
- Annex 132 Administrative Directorate of the General Staff of the Armed Forces of Ukraine Letter No. 300/1/C/3739 (20 July 2015)
- Annex 133 Report on Status and Condition of Military Units and Formations of the 1st Army Corps of the DPR, Obtained and Preserved by Ukrainian Military Intelligence (31 July 2015)
- Annex 134 Intelligence Briefing from the Main Intelligence Directorate of the Ukrainian Ministry of Defense No. 222/2D/1963dsk (14 September 2016)
- Annex 135 Expert opinion No. 14986/16-35, Kyiv Research Institute for Forensic Examinations of the Ministry of Justice of Ukraine (12 October 2015)
- Annex 136 Protocol of Inspection by I.V. Nimchenko, Senior Investigator on Special Cases of the Main Military Prosecutor's Office, Prosecutor General's Office of Ukraine (28 October 2015)
- Annex 137 Smerch Destruction Investigation Report (30 October 2015)
- Annex 138 Ukraine Executive Committee of the Kramatorsk City Council Letter No. F1-28/4812 to Investigations Department of the Donetsk Regional Directorate of the SSU (12 November 2015)
- Annex 139 Expert Opinion No. 8713/8714, Professor Emeritus M.S. Bokarius Kharkiv Scientific Research Institute of Forensic Expert Examinations of the Ministry of Justice of Ukraine (23 November 2015)

- Annex 140 Inspection Report by Colonel Roman Stepanovich Kovalchuk, Head of Operational Group of Military Counterintelligence of the Security Service of Ukraine (23 November 2015)
- Annex 141 Inspection Report by Colonel Vasyl Vasyliovych Kolodiazhnyi, the Deputy Head of Operational Group of Military Counterintelligence of the Security Service of Ukraine, B Sector (27 November 2015)
- Annex 142 Executive Committee of the Kramatorsk City Council Letter No. F1-28/4812 to the Investigations Department at the Donetsk Regional Directorate of the SBU (26 November 2015)
- Annex 143 Inspection Report of Colonel Vasyl Kolodiazhnyi, Head of Operational Group of Military Counterintelligence of the Security Service of Ukraine (23 November 2015)

Annex 106

Administrative Directorate of the General Staff of the Armed Forces of Ukraine
Letter No. 300/1/C/712 (13 February 2015)

This document has been translated from its original language into English, an official language of the Court, pursuant to Rules of the Court, Article 51.

Pursuant to Rules of the Court Article 51(3), Ukraine has translated only an extract of the original document constituting this Annex. In further compliance with this Rule, Ukraine has provided two certified copies of the full original-language document



GENERAL STAFF OF THE ARMED FORCES OF UKRAINE

6 Povitroflotsky Prospect, Kyiv-168, Ukraine

Phone: (044) 234-01-92. Fax: (044) 226-26-56

Administrative Directorate of the General
Staff of the Armed Forces of Ukraine

Ministry of Foreign Affairs of Ukraine

No. 300/1/C/712 of February 13, 2015

12:14:06 PM Page: 1/5



10985986461846881471

In pursuance of Instruction No. 02-01/2948 of October 15, 2014 issued by the Ukrainian Presidential Chief of Staff, presented herewith are informational reference materials pertaining to the body of evidence for the presence of foreign military groups in Ukrainian territory, to be used in raising the awareness of Ukrainian society and international partners more actively and in the future lawsuits to be filed by Ukraine with the relevant international courts.

Attachment: above-mentioned information on 5 pages, unclassified, for the specified recipient only

Acting First Deputy Chief of the General Staff of the Armed Forces of Ukraine

Major General

[Signature]

V.M. NAZAROV

O.M. Chekurda, 454-40-78

MINISTRY OF FOREIGN AFFAIRS OF
UKRAINE
DEPARTMENT OF THE GENERAL
SECRETARIAT
Incoming Ref. No. 14000

000455*

Order 210-2014

INFORMATIONAL REFERENCE MATERIALS
pertaining to the body of evidence for the direct invasion by foreign military groups into
Ukrainian territory

I. Regarding the involvement of Russian citizens in illegal paramilitary groups operating in Eastern Ukraine

On February 11 of this year, anti-aircraft defense forces (Buk-M1 surface-to-air missile system) downed a drone of the Russian Armed Forces near the Sarmat base camp of the Anti-Terrorist Operation. The drone was presumably launched from the area of Horlivka:

Drone (Model "Orlan-10") – 12:46 p.m., altitude of 1.5 km, distance of 4 km from the base camp. Notably, once the drone was downed the enemy launched an artillery attack targeting the area where the drone fell (the types of artillery systems and number of missiles will be updated).

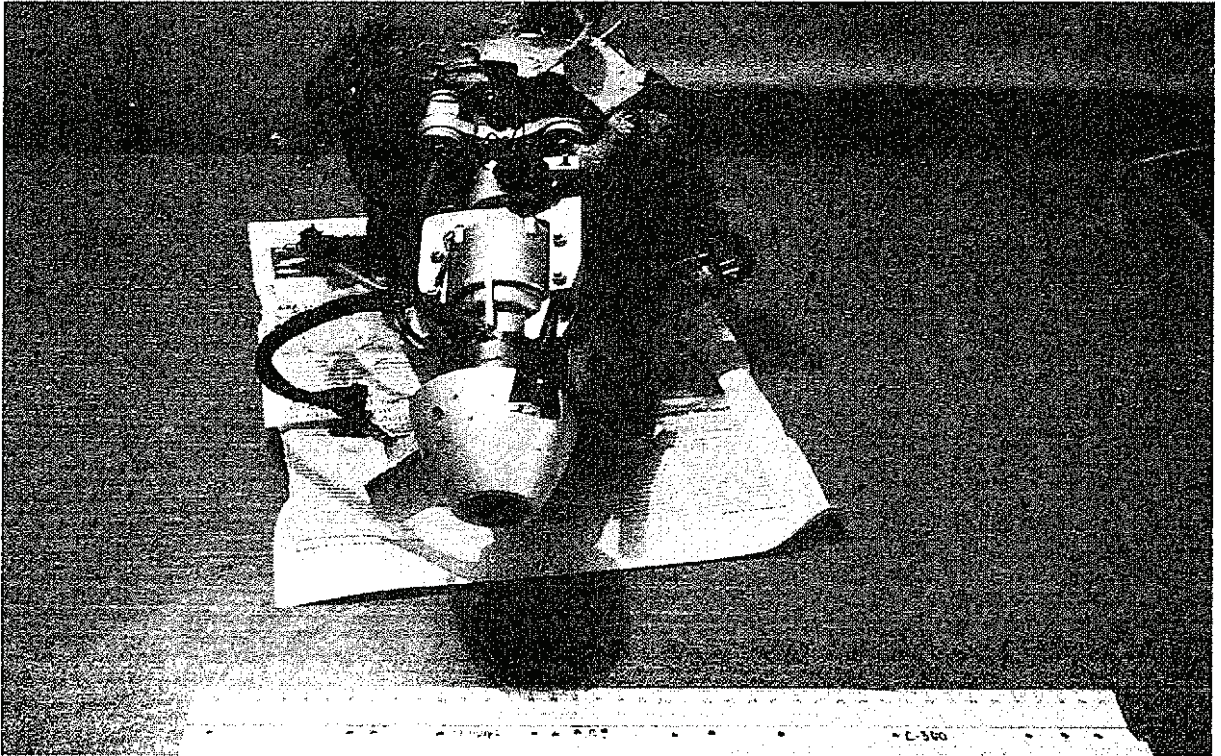
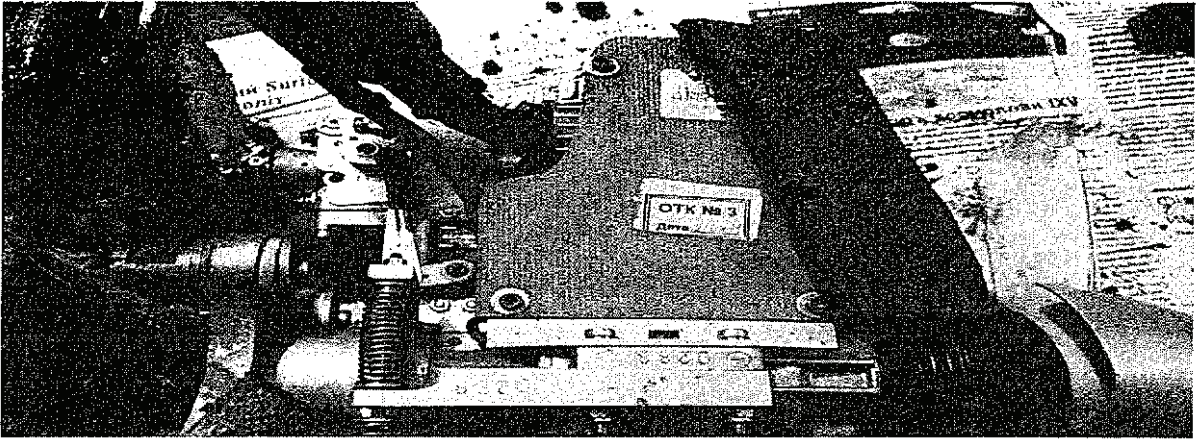

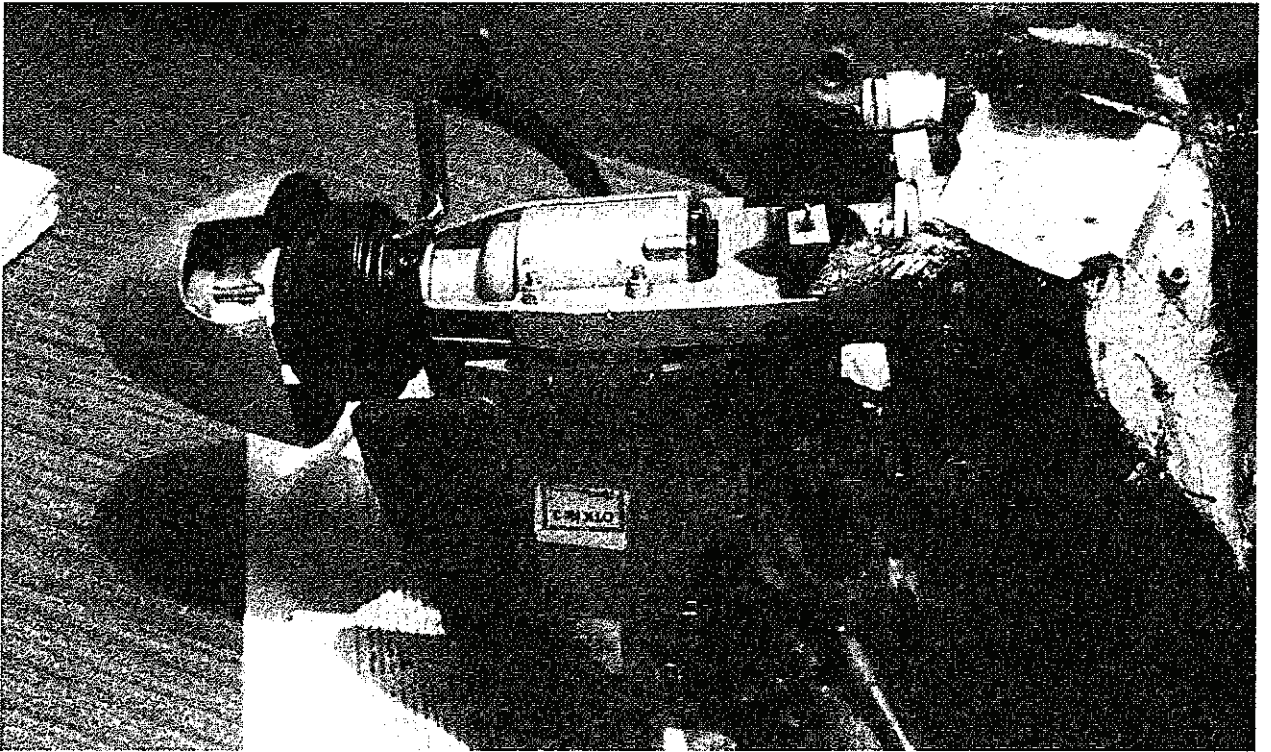
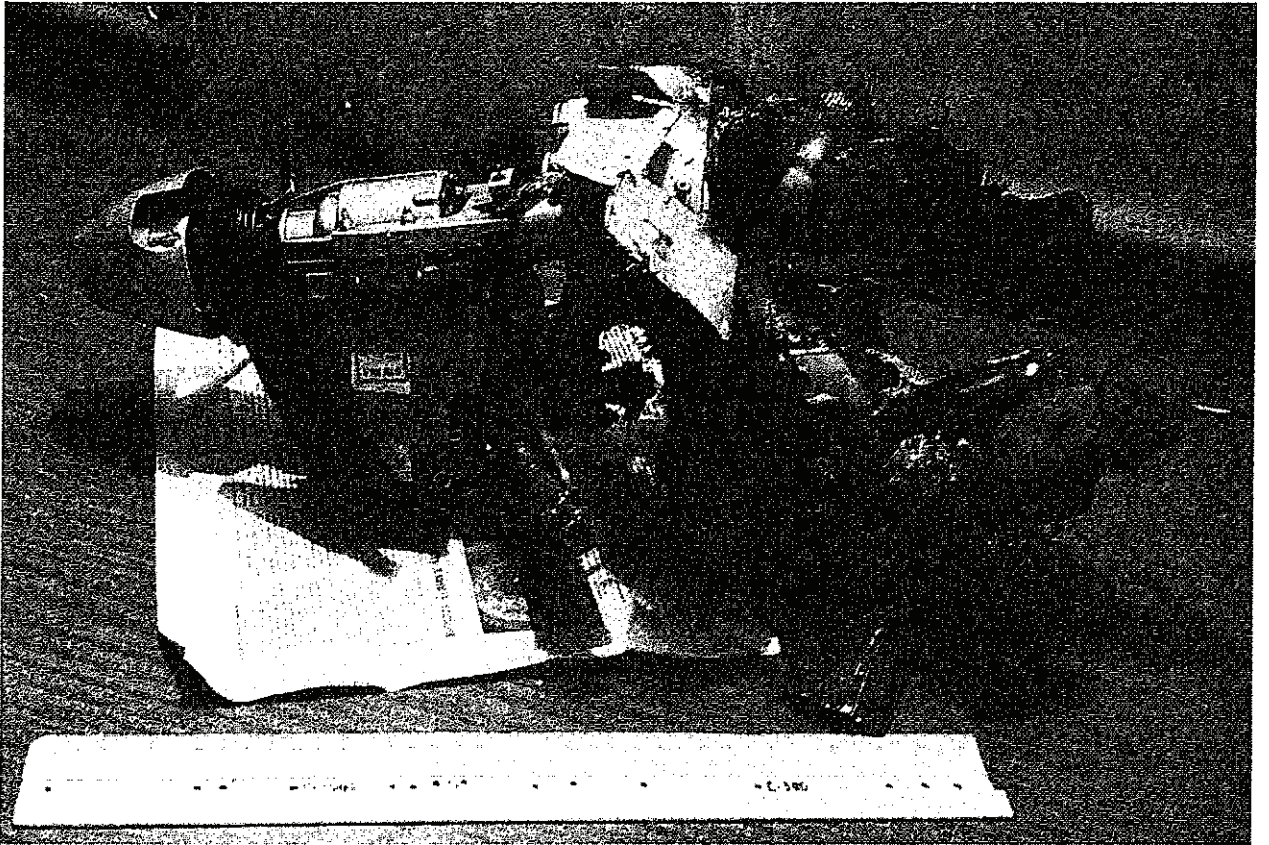

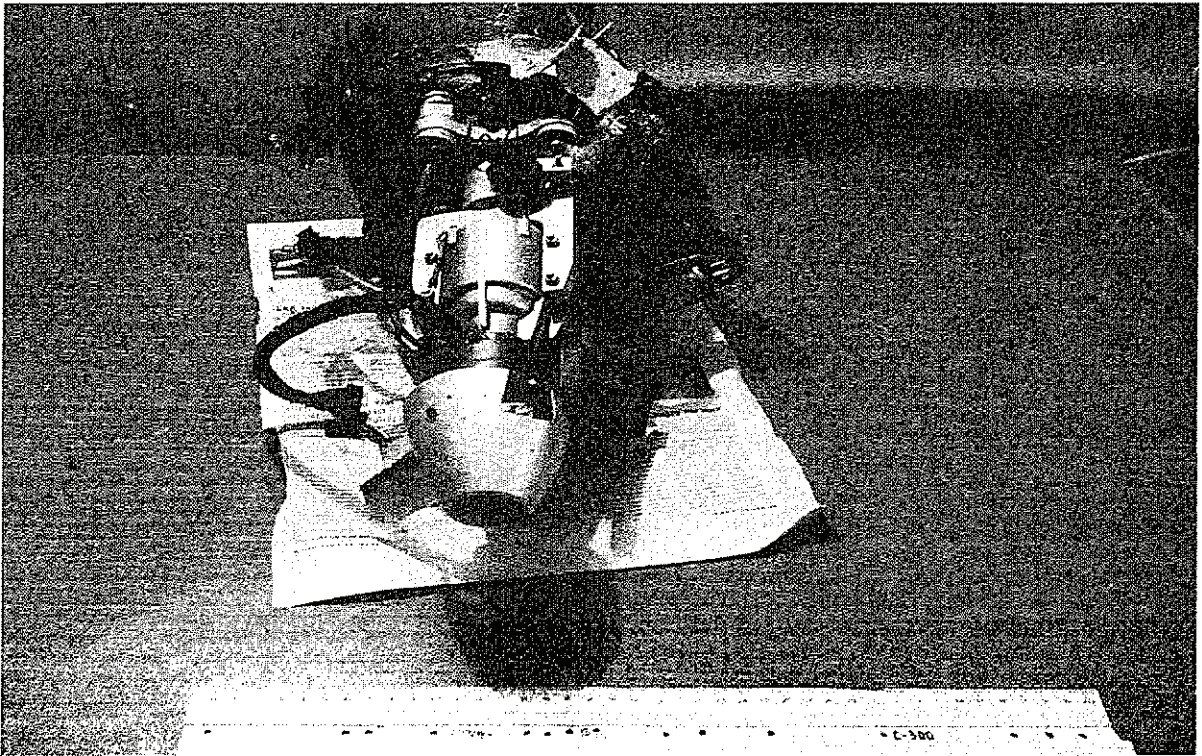
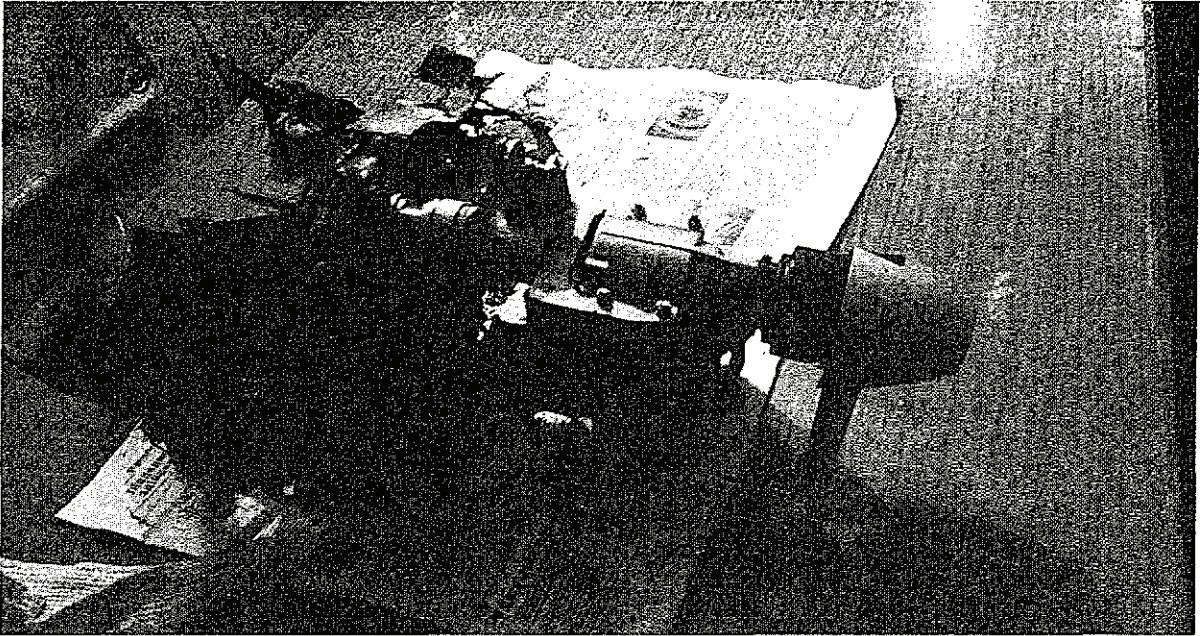

II. Regarding the chronology of the crossing of the state border of Ukraine by personnel, weapons, and military vehicles of the Armed Forces of the Russian Federation

No.	Date	Border crossing point crossed	Point of destination (crossing)	Number of convoys	Number of vehicles (personnel)
	February 11	GUKOVO (Rostov Oblast)	SVERDLOVSK, DEBALTSEVE		12 203-mm Pion self-propelled guns.
	February 11	NOVOAZOVSK	BEZIMENNE	1	Three T-64 tanks, up to 10 multiple rocket launchers (type to be updated);

	February 11	DYAKOVE		1	10 tanker trucks
	February 10	NOVOBOROVYTSI	ANTRATSIT, KRASNYYI LUCH	1	10 BTR-80 armored personnel carriers, 5 Ural-4320 trucks;
	February 10	DOVZHANSKY	ROVENKY-LUHANSK	1	Ten T-72B tanks, 20 BMP-2 infantry fighting vehicles, 10 motor vehicles.
	February 9	NAHULNA, TARASIVKA		1	60-80 KamAZ and Ural trucks carrying Russian military personnel presumably from the Central Asia (judging by their appearance)
	February 9	AMVROSIYIVKA,	SHAKHTARSK, DEBALTSEVE, KHARTSYZK, ZHDANIVKA, VUHLEHIRSK		30 tanks, 20 BMP infantry fighting vehicles, and 50 Ural tarpaulin trucks with ammunition.
	February 8		KRASNODON railway station		12 freight cars with ammunition
	February 8	IZVARYNE	LUHANSK		So-called "Humanitarian Convoy": 42 trucks and 21 tanker trucks.
	February 8	USPENKA	DONETSK		So-called "Humanitarian Convoy": 75 trucks and 20 tanker trucks.
	February 8	NOVOAZOVSK	MARKINO - KRASNOARMIYSKE		Up to 20 armored fighting vehicles, up to 5 Ural trucks, and 10 tanker trucks.
	February 8	DYAKOVE	ROVENKY		11 tanks (self-propelled guns), 10 BMP infantry fighting vehicles, 8 KamAZ trucks
	February 7	DMYTRIVKA	SNIZHNE	1	Five T-72 tanks, 10 tanker trucks
	February 7	DYAKOVE		1	40 military vehicles (tanks, BTR armored personnel carriers, 122-mm Grad multiple rocket launchers)
	February 7	IZVARYNE	LUHANSK	1	10 tanks and two BMP infantry fighting vehicles; 58 trucks with munitions and ammo
	February 7	IZVARYNE	ROVENKY	2	First – up to 15 trucks; second – 10 tanks.
	February 6	IZVARYNE	KRASNODON-LUHANSK	2	4 infantry fighting vehicles, 4 tanker trucks, and 28 KamAZ military trucks (8 presumably carrying personnel)
	February 6	DYAKOVO	from Ukrainian territory	2	Two BMP infantry fighting vehicles, 35 trucks.

	February 5	NOVOAZOVSK	TELMANOVE	2	10 trucks (type of cargo to be updated);
	February 5	DYAKOVO	undetermined destination	2	20 trucks with ammunition, 4 tanker trucks
	February 5	IZVARYNE	KRASNODON-LUHANSK	2	11 BMP infantry fighting vehicles, 40 trucks carrying personnel and ammunition;
	February 5	IZVARYNE	KRASNODON, LUHANSK	1	7 BMP infantry fighting vehicles.

Acting Chief
of the Main Command Center of the Armed Forces of Ukraine

Major General

[Signature]

B.V. BONDAR

Annex 107

Headquarters of the Antiterrorist Operation Letter No. 778 og (16 February 2015)

This document has been translated from its original language into English, an official language of the Court, pursuant to Rules of the Court, Article 51.

Pursuant to Rules of the Court Article 51(3), Ukraine has translated only an extract of the original document constituting this Annex. In further compliance with this Rule, Ukraine has provided two certified copies of the full original-language document



Antiterrorist Center
of the Security Service of Ukraine

**Headquarters
of the Antiterrorist Operation
on the Territory of the Donetsk
and Luhansk Regions**

No. 778 og
February 16, 2015

Kramatorsk, Donetsk Region

Lieutenant Colonel of Justice V. Panchenko
Head of the Office of Procedural Management of
Criminal Proceedings, Investigations Section,
Department for the Supervision of Compliance
with Laws on the Unified Forces of the Antiterrorist
Operation, Main Military Prosecutor's Office

*Mr. V.M. Panchenko, Mr. [illegible]:
For processing, [illegible]
02/17 [signature]*

The headquarters of the Antiterrorist Operation on the Territory of the Donetsk and Luhansk Regions (hereinafter "ATO") has reviewed your letter regarding the provision of information concerning the military servicemen who were wounded as a result of the terrorist act at the ATO headquarters on 02/10/2015.

Having examined the question posed in your letter, I hereby provide you with the following information:

No.	Full name	Date of birth	Military rank	Military unit	Healthcare facility where in-patient care is being received	
✓ 1	+ Vasyliy Petrovych SHULHA	11/29/1969	lieutenant colonel	A1225	Main Military Clinical Hospital of Kyiv	7 2
✓ 2	+ Yaroslav Volodymyrovych DYACHUK	07/31/1978	captain	A1225	Sitenko Institute of Traumatology and Orthopedics of Kharkiv	1
✓ 3	+ Vadym Mykhaylovych PAVLENKO	03/26/1988	major	A1225	Military Medical Clinical Center of Irpin	1 ⁶
4	- Serhiy Mykolayovych ZVARYCH	06/27/1973	colonel	MCC AFU ¹	(outpatient care)	15
✓ 5	+ Ihor Valentynovych SMOLEV	11/25/1976	private 1 st class	A4324	Military Hospital of Lutsk	2 ³
✓ 6	+ Taras Petrovych LUPENKO	03/26/1992	private 1 st class	A4324	Military Hospital of Lutsk	2 ³
✓ 7	+ Volodymyr Volodymyrovych KUKAY	10/10/1979	private	A4324	Military Hospital of Lutsk	2 ³
✓ 8	+ Vitaliy Vasylyovych SOLONKO	06/27/1977	sergeant 1 st class	A1519	Military Medical Clinical Center of the Central Region, Vinnytsya	3 ⁷
9	+ / - Oleksandr Dmytrovych CHORNYI	04/23/1974	lieutenant colonel	Military Prosecutor's office	(outpatient care)	0
✓ 10	+ Oleksandr Pavlovych BOHACHENKO	11/05/1974	ensign	A3516	Military Hospital of Poltava	4 ⁶
✓ 11	+ Andriy Hennadiyovych LESHCHENKO	10/02/1981	lieutenant 1 st class	A4324	Military Hospital of Lutsk	2 ³

Mr. O.A. Pohorelov [signature]

Incoming Ref. No. 343

¹ [Main Command Center of the Armed Forces of Ukraine]

No.	Full name	Date of birth	Military rank	Military unit	Healthcare facility where in-patient care is being received	
✓ 12	+ Volodymyr Volodymyrovych FEDOSEYEV	01/16/1980	major	A4150	Main Military Clinical Hospital of Kyiv	5 ¹
✓ 13	+ Oleksandr Leontiyovych BONDARCHUK	01/26/1973	ensign	A4324	Military Hospital of Lutsk	2 ³
✓ 14	+ Oleksandr Ivanovych FIZER	07/17/1987	private	A1556	Military Medical Clinical Center of the Southern Region, Kharkiv	6 ⁵
✓ 15	+ Mykhaylo Yuriyovych SERHIYKO	05/17/1972	sergeant	A3091	Military Hospital of Poltava	7 ⁴
16	- Oleksandr Oleksandrovych CHAHA		ensign 1 st class	SBU	(outpatient care)	0
✓ 17	+ Denys Olehovych HOYKO	06/14/1991	lieutenant 1 st class	CBS MODU ²	Main Military Clinical Hospital of Kyiv	16 ¹
18	- Vasyl Anatoliyovych KOVTUN	02/06/1965	colonel	MPD GS AFU ³	Kharkiv Institute of Emergency Surgery	17 ²
✓ 19	+ Valentin Mykhaylovych TYMOSHENKO	07/06/1994	junior sergeant	A0294	Military Medical Clinical Center of the Southern Region, Kharkiv	8 ⁵
✓ 20	+ Dmytro Andriyovych YAKYM	06/24/1985	lieutenant 1 st class	V0124	Military Medical Clinical Center of the Western Region, Lviv	9 ⁸
✓ 21	+ Serhiy Anatoliyovych TSYHANENKO	10/02/1980	private	V0124	Sitenko Institute of Traumatology and Orthopedics of Kharkiv	9 ²
22	- Oleksandr Petrovych HRECHANIKOV	05/04/1970	colonel	CAAC AFU ⁴	(outpatient care)	18
✓ 23	+ Dmytro Yuriyovych PARKHOMENKO	10/24/1987	ensign	V0124	Military Hospital of Poltava	9 ⁴
✓ 24	+ Vasyl Ivanovych SHTAYER	01/03/1991	private	V0124	Military Medical Clinical Center of the Southern Region, Kharkiv	9 ⁵
✓ 25	+ Vitaliy Mykolayovych HRYNCHUK	08/24/1976	captain	A1604	Sitenko Institute of Traumatology and Orthopedics of Kharkiv	10 ²
✓ 26	+ Yuriy Anatoliyovych YUSHKO		sergeant	State Border Service of Ukraine	Military Medical Clinical Center of the Southern Region, Kharkiv	20 ⁵
27	✓ Mykhaylo Yuriyovych KUZNETSOV	10/18/1972	lieutenant colonel	Kharkiv Air Force University	Military Medical Clinical Center of the Southern Region, Kharkiv	21 ⁵
✓ 28	+ Mykhaylo Vycheslavovych PRUT	11/20/1979	sergeant	V5229	Military Medical Clinical Center of the Southern Region, Kharkiv	11 ⁵
29	- Valeriy Henadiyovych MERIUTSA	03/28/1987	private 1 st class	A1604	(outpatient care)	10
30	- Yuriy Mykolayovych KURYS	05/04/1995	private	A0501	(outpatient care)	12

² [Central Broadcasting Studio of the Ministry of Defense of Ukraine]

³ [Main Personnel Deputy of the General Staff of the Armed Forces of Ukraine]

⁴ [Central Automobile Armament Command of the Armed Forces of Ukraine]

No.	Full name	Date of birth	Military rank	Military unit	Healthcare facility where in-patient care is being received	
✓ 31	+ Serhiy Olehovych GAYEVSKYY	07/15/1976	lieutenant colonel	V0226	Military Medical Clinical Center of the Southern Region, Kharkiv	15 ⁵
✓ 32	+ Volodymyr Petrovych RUD	06/24/1974	lieutenant colonel	A1119	Military Medical Clinical Center of the Southern Region, Kharkiv	14 ⁵
- 33	Volodymyr Volodymyrovych VOLOSHIN	09/07/1968	colonel	CRAAC AFU ⁵	(outpatient care)	19

Acting Chief of Staff /First Deputy Chief of Staff
for the Antiterrorist Operation on the Territory
of the Donetsk and Luhansk Regions
Colonel

[signature]

V.I. TERTICHNYY

⁵ [Central Rocket Artillery Armament Command of the Armed Forces of Ukraine]

Annex 108

Administrative Directorate of the General Staff of the Armed Forces of Ukraine
Letter No. 300/1/C/916 (23 February 2015)

This document has been translated from its original language into English, an official language of the Court, pursuant to Rules of the Court, Article 51.

Pursuant to Rules of the Court Article 51(3), Ukraine has translated only an extract of the original document constituting this Annex. In further compliance with this Rule, Ukraine has provided two certified copies of the full original-language document



MINISTRY OF DEFENSE OF UKRAINE
GENERAL STAFF OF THE ARMED FORCES OF
UKRAINE

6 Povitroflotsky Prospect, Kyiv, 03168. Phone: (044) 226-26-56. Fax: (044) 226-26-56

Email: kabmin_doc@mil.gov.ua

Code in the Uniform Register of Businesses and Organizations of Ukraine: 22991050

_____ No. _____

Administrative Directorate of the General
Staff of the Armed Forces of Ukraine

Foreign Ministry of Ukraine

No. 300/1/C/916 of February 23, 2015

9:54:12 AM Pages: 1/3



15429983714605876024

In pursuance of Instruction No. 02-01/2948 of October 15, 2014 issued by the Ukrainian Presidential Chief of Staff, presented herewith are informational reference materials pertaining to the body of evidence for the presence of foreign military groups in Ukrainian territory, to be used in raising the awareness of Ukrainian society and international partners more actively and in the future lawsuits to be filed by Ukraine with the relevant international courts.

Attachment: above-mentioned information on 3 pages, unclassified, for the specified recipient only

Acting First Deputy Chief
of the General Staff of the Armed Forces of Ukraine

Major General

[Signature]

V.M. NAZAROV

O.O. Dudnyk, 454-40-78

FOREIGN MINISTRY OF UKRAINE
DEPARTMENT OF THE GENERAL SECRETARIAT
Incoming Ref. No. 16258
February 26, 2015

000990*

Order 50-215

INFORMATIONAL REFERENCE MATERIALS
 pertaining to the body of evidence for the direct invasion by foreign military groups into
 Ukrainian territory

I. Regarding the involvement of Russian citizens in illegal paramilitary groups operating in Eastern Ukraine

No documented facts of the involvement of Russian citizens in illegal paramilitary groups operating in Eastern Ukraine were recorded last week.

II. Regarding the chronology of the crossing of the state border of Ukraine by personnel, weapons, and military vehicles of the Armed Forces of the Russian Federation

No.	Date	Border crossing point crossed	Point of destination (crossing)	Number of convoys	Number of vehicles (personnel)
1.	February 18	through IZVARYNE		1	close to 200 people (mostly Chechens and Buryats)
2.	February 18	through IZVARYNE	in the direction of KRASNODON, LUHANSK	1	eight trucks (carrying personnel, munitions, and ammo); 18 trucks crossed into the Russian Federation going in the opposite direction;
3.	February 18	through GUKOVO (Russian Federation)	to SVERDLOVSK	1	7 tanks, 11 BTR armored personnel carriers, 4 trucks with ammunition.
4.	February 17	IZVARYNE	(Russian Federation)	1	56 empty trucks.
5.	February 17	IZVARYNE	KRASNODON, LUHANSK	2	78 trucks (with munitions and ammo);
6.	February 17		railway station of ILOVAYSK	Train	60 122-mm Gvozdika self-propelled guns
7.	February 17	DIBRIVKA	STEPANIVKA-SHAKHTARSK		20 KamAZ trucks (with munitions and ammo).
8.	February 17	DIBRIVKA	DMYTRIVKA	1	one TOS-1 "Buratino" multiple rocket launcher, one 9P140 Uragan multiple rocket launcher, as well as 17 trucks with ammo;
9.	February 16	MARYNIVKA	to the Russian Federation		BTR armored personnel carrier, 12 buses (with tinted windows), 6 trucks and 8 off-road vehicles
10.	February 16	IZVARYNE	to the Russian Federation		12 armored fighting vehicles and 43 trucks (presumably empty)
11.	February 16	DMYTRIVKA	STEPANIVKA	1	6 tanks, 21 KamAZ trucks (with munitions and ammo), and 10 tanker trucks

No.	Date	Border crossing point crossed	Point of destination (crossing)	Number of convoys	Number of vehicles (personnel)
12.	February 16	IZVARYNE	KRASNODON, LUHANSK	1	12 armored fighting vehicles, two 122-mm GRAD multiple rocket launchers, 104 trucks (with munitions and ammo).
13.	February 15	from Russian territory	Uspenka, Izvaryne	2	Another (14 th) "Humanitarian Convoy" entered the temporarily occupied territories of Ukraine: 176 trucks and 354 personnel, as well as 1,400 tons of cargo. All trucks left Ukraine after unloading.
14.	February 15	IZVARYNE	LUHANSK	1	Four white tanker trucks.
15.	February 15	from Russian territory	DIBRIVKA, GUKOVO	3	Two convoys: nine BMP infantry fighting vehicles, 35 trucks with personnel and ammunition (including two trucks with personnel, eight trucks with ammunition for multiple rocket launchers), 20 tanker trucks; to SVERDLOVSK (Luhansk Oblast) – 20 KamAZ trucks with ammunition.
16.	February 15	from the railway station of ILOVAYSK	To the Russian Federation	1	10 freight cars with military casualties.
17.	February 14		railway station of ILOVAYSK	Train	with military vehicles: 12 tanks, 20 rail cars for personnel
18.	February 14	KYZNETSY (Donetsk Oblast)	KRASNOARMIYSKE, BEZIMENNE		two BMP infantry fighting vehicles, six tanks, 10 self-propelled guns, 12 trucks
19.	February 14	MAXYMIV (Russia)	NOVOAZOVSK		20 tanks;
20.	February 14	IZVARYNE	KRASNODON, LUHANSK		20 trucks; 10 tanker trucks, 15 trucks with munitions and ammo; bus and two passenger cars with personnel. Five armored fighting vehicles left Ukraine and crossed into the Russian Federation;

No.	Date	Border crossing point crossed	Point of destination (crossing)	Number of convoys	Number of vehicles (personnel)
21.	February 13	DIBRIVKA			10 tanker trucks and 20 trucks with ammunition (for multiple rocket launchers). Also, a convoy of empty trucks and buses left Ukraine through this population center.
22.	February 13	NOVOAZOVSK	TELMANOVE	1	18 tanks (T-64, T-72, T-90), 5 multiple rocket launchers (Uragan or Smerch; type to be updated).
23.	February 13	DMYTRIVKA	SNIZHNE	1	40 trucks and 10 tanker trucks;
24.	February 13	CHERVONOPARTYZANSK	SVERDLOVSK	1	eight tanks, two "Pantsyr-S1" surface-to-air missile systems, 12 trucks (with ammunition);
25.	February 13	IZVARYNE	KRASNODON	3	61 trucks (one towing ZU-23-2 anti-aircraft autocannon), three tanker trucks;
26.	February 12		railway station of ILOVAYSK	Train	30 freight cars, including 10 freight cars carrying infantry weapons, 20 rail tank cars, 40 tanks, 100 armored fighting vehicles and multiple rocket launchers;
27.	February 12	IZVARYNE	KRASNODON	5	56 trucks (53 with munitions and ammo; 3 with personnel), four tanker trucks, bus with personnel;
28.	February 12	NOVOAZOVSK	BEZIMENNE	1	Seven T-64 tanks.
29.	February 11	GUKOVO (Rostov Oblast)	SVERDLOVSK, DEBALTSEVE	1	12 203-mm Pion self-propelled guns.
30.	February 11	NOVOAZOVSK	BEZIMENNE	1	Three T-64 tanks, up to 10 multiple rocket launchers (type to be updated);
31.	February 11	DYAKOVE		1	10 tanker trucks
32.	February 10	IZVARYNE	KRASNODON	1	T-72 tanks and Ural trucks totaling 46 units
33.	February 10	NOVOBOROVYTSI	ANTRATSIT, KRASNYYI LUCH	1	10 BTR armored personnel carriers, 5 Ural-4320 trucks;
34.	February 10	DOVZHANSKY	ROVENKY-LUHANSK	1	Ten T-72B tanks, 20 BMP-2 infantry fighting vehicles, 10 motor vehicles.

Acting Chief
of the Main Command Center of the Armed Forces of Ukraine
Major General

[Signature]

B.V. BONDAR

Annex 109

Administrative Directorate of the General Staff of the Armed Forces of Ukraine
Letter No. 300/1/C/1059 (27 February 2015)

This document has been translated from its original language into English, an official language of the Court, pursuant to Rules of the Court, Article 51.

Pursuant to Rules of the Court Article 51(3), Ukraine has translated only an extract of the original document constituting this Annex. In further compliance with this Rule, Ukraine has provided two certified copies of the full original-language document



MINISTRY OF DEFENSE OF UKRAINE
GENERAL STAFF OF THE ARMED FORCES OF
UKRAINE

6 Povitroflotsky Prospect, Kyiv, 03168. Phone: (044) 226-26-56. Fax: (044) 226-26-56

Email: kabmin_doc@mil.gov.ua

Code in the Uniform Register of Businesses and Organizations of Ukraine: 22991050

_____ No. _____

Administrative Directorate of the General
Staff of the Armed Forces of Ukraine

Foreign Ministry of Ukraine

No. 300/1/C/1059 of February 27, 2015

3:30:06 PM Pages: 1/7



15123386584287035634

In pursuance of Instruction No. 02-01/2948 of October 15, 2014 issued by the Ukrainian Presidential Chief of Staff, presented herewith are informational reference materials pertaining to the body of evidence for the presence of foreign military groups in Ukrainian territory, to be used in raising the awareness of Ukrainian society and international partners more actively and in the future lawsuits to be filed by Ukraine with the relevant international courts.

Attachment: above-mentioned information on 7 pages, unclassified, for the specified recipient only

Acting First Deputy Chief

of the General Staff of the Armed Forces of Ukraine

Major General

[Signature]

V.M. NAZAROV

O.O. Dudnyk, 454-40-78

FOREIGN MINISTRY OF UKRAINE
DEPARTMENT OF THE GENERAL SECRETARIAT
Incoming Ref. No. 18176
March 4, 2015

000233*

Order 356-2015

[. . .]

II. Regarding the chronology of the crossing of the state border of Ukraine by personnel, weapons, and military vehicles of the Armed Forces of the Russian Federation

No.	Date	Border crossing point crossed	Point of destination (crossing)	Number of convoys	Number of vehicles (personnel)
1.	February 25	DOVZHANSKY	SVERDLOVSK		2 tanks; trucks (100 military personnel of the Russian Armed Forces and ammunition);
2.	February 25	IZVARYNE	LUHANSK		2 BM-21 GRAD multiple rocket launchers; 42 trucks, 7 tanker trucks;
3.	February 25		TELMANOVE		20 tanks, 20 BM-21 GRAD multiple rocket launchers
4.	February 25	DIBRIVKA – DMYTRIVKA			20 trucks and 2 tracked vehicles (presumably engineering vehicles).
5.	February 24	DMYTRIVKA	STEPANIVKA	Convoy	50 KamAZ trucks (20 towing cannon on trailers, 30 with munitions and ammo).
6.	February 24	IZVARYNE	KRASNODON, LUHANSK	1	14 trucks (with munitions and ammo)
7.	February 24	IZVARYNE		1	27 tarpaulin trucks with ammo.
8.	February 23	IZVARYNE	LUHANSK		10 trucks, 1 BMP infantry fighting vehicle;
9.	February 23	DMYTRIVKA	MARYNIVKA, STEPANIVKA		40 trucks (with munitions and ammo)
10.	February 23	DMYTRIVKA	STEPANIVKA		Seven T-72 tanks, three KamAZ trucks with munitions and ammo.
11.	February 23	CHERVONOPARTYZANSK	SVERDLOVSK		Eight T-80 tanks and fourteen T-72 tanks, 12 self-propelled guns, two Pantsir-S1 surface-to-air missile systems, 20 trucks with ammunition.
12.	February 23	IZVARYNE	KRASNODON, LUHANSK		37 trucks with munitions and ammo.
13.	February 22	CHERVONOPARTYZANSK	SVERDLOVSK	1	7 tanks, 5 armored fighting vehicles, 8 trucks with ammunition
14.	February 22	IZVARYNE	KRASNODON, LUHANSK	2	37 trucks (with munitions and ammo)
15.	February 22	IZVARYNE	to the Russian Federation	1	33 trucks (with personnel and munitions) and 2 tanker trucks
16.	February 22	SAMOYLOVO	to the Russian Federation	1	4 tanks, 2 BM-21 GRAD multiple rocket launchers, 1 self-propelled gun
17.	February 22	NOVOAZOVSK	KRASNOARMIYSKE	1	10 Ural trucks carrying personnel and 3 Ural trucks with ammunition.

18.	February 22	KYZNETSY (Donetsk Oblast)	KRASNOARMIYSKE	1	12 tanks, 7 BM-21 Grad multiple rocket launchers, 5 self-propelled guns, and 7 trucks with food and ammunition.
-----	-------------	---------------------------	----------------	---	---

No.	Date	Border crossing point crossed	Point of destination (crossing)	Number of convoys	Number of vehicles (personnel)
19.	February 21	IZVARYNE	KRASNODON, LUHANSK	1	51 trucks with ammunition and cannon towed on trailers (4), 1 armored fighting vehicle.
20.	February 21	KYZNETSY (Donetsk Oblast)	NOVOAZOVSK	1	50 trucks with munitions and ammo.
21.	February 21	From the Russian Federation	to AMVROSIYIVKA railway station (Donetsk Oblast)	1	Train with military vehicles – 60 armored fighting vehicles (mostly tanks).
22.	February 21	IZVARYNE	to the Russian Federation	1	11 trucks (2 with personnel) and 6 armored fighting vehicles left Ukraine;
23.	February 21	IZVARYNE	to the Russian Federation	1	6 BTR armored personnel carriers
24.	February 21	DYAKOVO	CHERVONYI ZHOVTEN	1	Three 2S4 Tulpan self-propelled mortars
25.	February 21	SVERDLOVSK	In the direction of Route M-03 (Rostov-Kharkiv)	1	12 tanks, 4 KrAZ trucks, and 1 KamAZ truck with ammunition.
26.	February 20	ANTRATSIT	DYAKOVO (Russian Federation)		20 tanks, 20 BTR armored personnel carriers, 2 trucks towing cannon on trailers
27.	February 20	IZVARYNE	to the Russian Federation	1	25 trucks towing cannon on trailers
28.	February 20	KHARTSYZK	ZUGREZ	1	Five 9P149 Uragan multiple rocket launchers
29.	February 20	DMYTRIVKA	KUIBYSHEVO (Russian Federation)	1	Ten BM-21 Grad multiple rocket launchers, 10 KamAZ trucks and 10 tanker trucks
30.	February 20	through IZVARYNE, through USPENKA	in the direction of LUHANSK, in the direction of DONETSK	2	Humanitarian Convoy consisting of 16 trucks, Humanitarian Convoy consisting of 14 trucks
31.	February 19	IZVARYNE	to the Russian Federation	1	8 tanks and 32 empty trucks.

Acting Chief

of the Main Command Center of the Armed Forces of Ukraine

Major General

[Signature]

B.V. BONDAR

Annex 110

Central Missile and Artillery Directorate Of the Armed Forces of Ukraine Letter No.
342/2/3618 (11 March 2015).

This document has been translated from its original language into English, an official language of the Court, pursuant to Rules of the Court, Article 51.

Pursuant to Rules of the Court Article 51(3), Ukraine has translated only an extract of the original document constituting this Annex. In further compliance with this Rule, Ukraine has provided two certified copies of the full original-language document

Head of the Kharkiv Regional Directorate
of the Security Service of Ukraine
Col O. Pyvovar

A.O. Proshnyak
for the proceedings file
[signature] 09.21.15

[stamp illegible]

03.11.15

342/2/3618

Ref. No 70/6-635 of 02.10.2015

The Central Missile and Artillery Directorate of the Procurement of the Armed Forces of Ukraine has processed your request as regards the following firearms registered in the Armed Forces of Ukraine:

- **5.45 mm AK-74 automatic rifles No. 3760057, 3759198 and 4292512;**
- **40 mm GP-25 under-barrel grenade launcher No 982524.**
-

The commander of military unit No. A4176 reports as follows:

A review of inventory data provided by military units to military unit A4176 (city of Artemivsk) summed up in the departmental data bank of the Arsenal state electronic database for the Armed Forces of Ukraine has established the following.

- **The 5.45 mm AK-74 automatic rifles No. 3760057 manufactured in 1985 and No. 3759198 manufactured in 1985** were registered at military unit A2506 (town of Novo Ozernoe, Autonomous Republic of Crimea).

- **The 5.45 mm automatic rifle No. 4292512 manufactured in 1986** was registered at military unit A3009 (town of Sevastopol, Autonomous Republic of Crimea).

The Central Missile and Artillery Directorate of the Procurement of the Armed Forces of Ukraine has no information as to whether these weapons are present or missing because all the property of the military unit's missile and artillery procurement service remained in the occupied territory.

As for the other point raised in the request, it has been established that the weapons bearing the above factory numbers are neither registered nor present at the military units of the Armed Forces of Ukraine, have not been stolen, lost or written off and have not been transferred to other military units (organizations).

Acting Head,
Central Missile and Artillery Directorate
of the Armed Forces of Ukraine,
Procurement of the Armed Forces of Ukraine
Colonel

[signature]

O.V.Syenko

[stamp:] THIS IS A TRUE COPY
Senior Investigator,
Investigations Department,
Kharkiv Regional Directorate
of the Security Service of Ukraine
Senior Lieutenant

[round seal, illegible]

[stamp] ref. 6/1652

03.20.2015

[signature]

N.V.Berehulya, 293-43

02.10.2015

Annex 111

Administrative Directorate of the General Staff of the Armed Forces of Ukraine
Letter No. 300/1/C/1451 (20 March 2015)

This document has been translated from its original language into English, an official language of the Court, pursuant to Rules of the Court, Article 51.

Pursuant to Rules of the Court Article 51(3), Ukraine has translated only an extract of the original document constituting this Annex. In further compliance with this Rule, Ukraine has provided two certified copies of the full original-language document



MINISTRY OF DEFENSE OF UKRAINE
GENERAL STAFF OF THE ARMED FORCES OF
UKRAINE

6 Povitroflotsky Prospect, Kyiv, 03168. Phone: (044) 226-26-56. Fax: (044) 226-26-56

Email: kabmin_doc@mil.gov.ua

Code in the Uniform Register of Businesses and Organizations of Ukraine: 22991050

_____ No. _____

Administrative Directorate of the General Staff of the
Armed Forces of Ukraine

Foreign Ministry of Ukraine

No. 300/1/C/1451 of March 20, 2015

10:02:50 am Pages: 1/2



09764980894435723749

In pursuance of Instruction No. 02-01/2948 of October 15, 2014 issued by the Ukrainian Presidential Chief of Staff, presented herewith are informational reference materials pertaining to the body of evidence for the presence of foreign military groups in Ukrainian territory, to be used in raising the awareness of Ukrainian society and international partners more actively and in the future lawsuits to be filed by Ukraine with the relevant international courts.

Attachment: above-mentioned information on 2 pages, unclassified, for the specified recipient only

Acting First Deputy Chief
of the General Staff of the Armed Forces of Ukraine

Lieutenant General

[Signature]

S.B. BESSARAB

D.S. Pasko, 454-40-78

FOREIGN MINISTRY OF UKRAINE
DEPARTMENT OF THE GENERAL SECRETARIAT
Incoming Ref. No. 25002
March 25, 2015

000681*

Order 50-2015

INFORMATIONAL REFERENCE MATERIALS
 pertaining to the body of evidence for the direct invasion by foreign military groups into
 Ukrainian territory

I. Regarding the involvement of Russian citizens in illegal paramilitary groups operating in Eastern Ukraine

No documented facts of the involvement of Russian citizens in illegal paramilitary groups operating in Eastern Ukraine were recorded last week.

II. Regarding the chronology of the crossing of the state border of Ukraine by personnel, weapons, and military vehicles of the Armed Forces of the Russian Federation

No.	Date	Border crossing point crossed	Point of destination (crossing)	Number of convoys	Number of vehicles (personnel)
1	March 17	IZVARYNE	KRASNODON	1	6 armored fighting vehicles and 2 tanker trucks
2	March 17	Sukhodolsk railway station (Luhansk Oblast)	From the Russian Federation	Train	train with munitions and ammo
3	March 17	Dmytrivka	in the direction of Stepanivka	1	10 T-72 tanks
4	March 17	Izvaryne	Luhansk	1	6 armored fighting vehicles, 2 tanker trucks;
5	March 16	DIBRIVKA	SNIZHNE		Ten T-72 tanks, 20 trucks carrying ammo, and 3 special-purpose (engineering) vehicles.
6	March 16	CHERVONOPART YZANSK	SVERDLOVSK		14 tanks.
7	March 16	From the Russian Federation	KHARTSYZK railway station	Train	with military vehicles and ammunition
8	March 16	From the Russian Federation	SVERDLOVSK railway station	Train	with military vehicles and ammunition
9	March 16	From the Russian Federation	KRASNODON railway station	Train	with military vehicles and ammunition
10	March 16	From the Russian Federation	DEBALTSEVE railway station	Train	with military vehicles and ammunition
11	March 15	IZVARYNE	LUHANSK	1	10 tarpaulin trucks, one carrying a ZU-23-2 anti-aircraft twin-barreled autocannon
12	March 15	IZVARYNE	LUHANSK	1	20 th "Humanitarian Convoy": 38 trucks
13	March 15	USPENKA	MAKIYIVKA	1	20 th "Humanitarian Convoy": 42 vehicles

No.	Date	Border crossing point crossed	Point of destination (crossing)	Number of convoys	Number of vehicles (personnel)
14	March 13	IZVARYNE	LUHANSK	1	19 th "Humanitarian Convoy": 23 vehicles
15	March 13	USPENKA	DONETSK	1	19 th "Humanitarian Convoy": 27 trucks
16	March 13	DOVZHANSKY	LUHANSK	1	Twenty 122-mm GRAD multiple rocket launchers
17	March 12	DOVZHANSKY	SVERDLOVSK	1	23 tanks, 5 122-mm GRAD multiple rocket launchers, 5 trucks with ammunition

Acting Chief
of the Main Command Center of the Armed Forces of Ukraine

Major General

[Signature]

B.V. BONDAR

Annex 112

Expert Conclusion No. 557/2014, drafted by the Forensic Research Center, Ministry of Internal Affairs of Ukraine, Main Directorate of the Ministry of Internal Affairs of Ukraine in Kharkiv Region (23 March 2015)

This document has been translated from its original language into English, an official language of the Court, pursuant to Rules of the Court, Article 51.

Pursuant to Rules of the Court Article 51(3), Ukraine has translated only an extract of the original document constituting this Annex. In further compliance with this Rule, Ukraine has provided two certified copies of the full original-language document

MINISTRY OF INTERNAL AFFAIRS OF UKRAINE
MAIN DIRECTORATE OF THE MINISTRY OF INTERNAL AFFAIRS OF UKRAINE
IN KHARKIV REGION
FORENSIC RESEARCH CENTER

34 vul. Kovtuna, Kharkiv
Tel. (057)721-23-39
Vvtptd_kharkov@ukr.net

EXPERT CONCLUSION

03.23.2015

Kharkiv

No. 557/2014

The forensic fire and explosives analysis department of the Forensic Research Center (FEAD FRC) at the Kharkiv Region Main Directorate of the Ministry of Internal Affairs of Ukraine received on 12.02.2014 a resolution dated 12.02.2014 issued by investigator Lt O.I. Huskov of the investigations department at the Kharkiv Regional directorate of the Security Service of Ukraine as part of criminal proceedings No. 2201422000000283, accompanied by letter No. 70/6-1903 of 12.02.2014 from the Kharkiv Regional Directorate of the Security Service of Ukraine, requesting a comprehensive forensic explosives analysis of explosive substances and products of explosion and gunfire.

The task of forensic analysis has been assigned to the chief explosives expert of the fire forensics sector at FEAD FRC, Ye.O. Bosenko, who has a full higher education degree and is a qualified forensic expert certified to conduct forensic explosives analysis according to expert specialism No. 5.2 (investigation of explosive devices, traces and circumstances of an explosion, certificate No. 10918 issued by the Expert Qualifications Commission of the Ministry of Internal Affairs of Ukraine on 10.25.2011) and employed as an expert since 2001; and senior explosives expert at FEAD FRC, Vladyslav Mykhaylovych Hapon, who has a higher education degree in chemistry and is a qualified forensic expert certified to conduct forensic analysis according to expert specialism No. 5.2 (investigation of explosive devices, traces and circumstances of an explosion, certificate No. 12382 issued by the Expert Qualifications Commission of the Ministry of Internal Affairs of Ukraine on 10.09.2013) as well as a qualified forensic expert certified to conduct forensic analysis in expert specialism No. 5.[rest of the number not visible] (investigation of explosive devices and products of explosion and gunfire), certificate No. 9225 issued by the Expert Qualifications Commission of the Ministry of Internal Affairs of Ukraine on 05.07.2009, certificate confirming forensic expert qualification No. 1134 issued by the Expert Qualifications Commission of the Ministry of Internal Affairs of Ukraine on 11.24.2014, and employed as an expert since 2007.

[seal:]

Forensic Research Center No. 12
Kharkiv Region Main Directorate
Ministry of Internal Affairs of Ukraine
[signature] [signature]

Forensic experts

Ye.O. Bosenko
V.M. Hapon

I understand that a deliberately false conclusion and unjustified refusal to perform assigned duties is an offence under Articles 384 and 385 of the Penal Code of Ukraine.

[seal:]

Forensic Research Center No. 12 [signature] **Ye.O. Bosenko**
Kharkiv Region Main Directorate
Ministry of Internal Affairs of Ukraine [signature] **V.M. Hapon**

Background on the case (*known from the investigator's resolution to request a forensic analysis*): "A terrorist group named Kharkiv Guerrillas was set up and operated in Kharkiv Region throughout July–October 2014. Its purpose was to commit terrorist acts with the aim of destabilizing the situation in society, intimidate the population and violate public safety using weapons and staging explosions.

"In particular, the above group staged an armed attack on the Loziv District military commissariat, blew up an electricity tower near the village of Bezlyudivka in Kharkiv District and committed other acts of terror and sabotage.

"For example, during the period from November 12 to 16, unidentified persons, most likely members of the Kharkiv Guerillas terrorist organization, in order to violate public safety, intimidate the population and draw attention to their political views, staged an explosion at the technical mine with communications lines belonging to the state enterprise Malyshev Factory at Morozov Street in Kharkiv, damaging a pipe at the center of the technical mine, metal bars located on the surface of the technical mine to prevent entry, as well as the technical well.

"An inspection of the scene of the incident on 11.16.2014 led to the discovery of a grey metal fragment with traces of a rupture, a metal wire fragment, a metal fragment with remnants of grooving on the surface, a tampon soaked with runoff from the opening of the damaged pipe, a grey metal fragment with damaged edges, a plastic fragment (Bakelite) painted grey on one side, a yellow-colored metal fragment with remnants of grooving on one side, two fragments with magnetic properties, a wire fragment, a plastic fragment (Bakelite), a cylindrically shaped metal fragment with traces of deformation in the form of dents and flattening, a flat grey-colored metal wire fragment and five grey metal fragments."

The following was submitted for forensic analysis:

- picture illustrating the scene of the incident;
- ✓✓ fragments found after sifting at the scene of the incident, sealed in the Ministry of Internal Affairs of Ukraine expert service bag No. 0509012;
- ✓✓ grey plastic fragment sealed in the Ministry of Internal Affairs of Ukraine expert service bag No. 0508997;
- X wire fragment sealed in the Ministry of Internal Affairs of Ukraine expert service bag No. 0508999;
- tampon soaked in runoff from the opening of the damaged pipe sealed in the Ministry of Internal Affairs of Ukraine expert service bag No. 0508996;

[seal:]

Forensic experts Forensic Research Center No. 12
Kharkiv Region Main Directorate
Ministry of Internal Affairs of Ukraine [signature] [signature] **Ye.O. Bosenko**
V.M. Hapon

- ✓✓ grey metal fragment with traces of rupture sealed in the Ministry of Internal Affairs of Ukraine expert service bag No. 0509016;
- ✓✓ metal fragment with traces of grooving on the surface sealed in the Ministry of Internal Affairs of Ukraine expert service bag No. 0509014;
- ✓ metal fragment with damaged edges sealed in the Ministry of Internal Affairs of Ukraine expert service bag No. 1157665

The following questions were put to forensic analysis:

1. Are the objects found at the scene of the incident parts of an explosive device, and if yes, what type of device do they belong to?
2. Do the objects found at the scene of the incident bear traces of explosive substances, and if yes, which ones?
3. Was the explosion caused by ammunition or an explosive device, and if yes, what type (hand grenades, mortar, shells, etc.)?
4. What method was used in this case to cause the explosion?

List of forensic analysis methods entered in the Register of Forensic Analysis Methods at the Ministry of Justice of Ukraine and used in this analysis:

1. Comprehensive investigation of explosive devices, explosive substances and traces of explosion (registration code 0.1.12).
2. Explosive substance investigation (registration code 5.1.15).
3. Investigation of explosive substances and explosion products using chemical methods and thin-layer chromatography (registration code 5.1.23).

INVESTIGATION

Investigation of the submitted illustration material

After investigating the illustration material (illustrative picture from the scene of the incident) it was established that the metal bars on the surface of the technical mine and the technical well show damage by way of deformation and displacement. In the middle of the technical mine there is a metal pipe with an opening on the lateral surface. The opening is characterized by uneven, jagged edges turned inside the pipe. Also on the surface of the pipe, around the opening, there is a black deposit which looks like soot. The amount of deposit decreases further away from the edges. The above characteristics are typical consequences of an explosion.

Appearance of the objects provided [1,5]

The objects were delivered for investigation sealed in 7 standard bags of the Ministry of Internal Affairs of Ukraine Expert Service: packages No. 1–7 (figures 1, [not visible]) on the illustrative table appended to the expert conclusion).

Package No. 1 is a polymeric bag, the face of which bears the image of the Expert Service seal and printed factory markings and lines in the manner of a form partially completed in longhand using blue ink.

[seal:]

Forensic Research Center No. 12
Kharkiv Region Main Directorate
Ministry of Internal Affairs of Ukraine
[signature] [signature]

Forensic experts

**Ye.O. Bosenko
V.M. Hapon**

Ministry of Internal Affairs of Ukraine Directorate in _____ city, district _____

Description: *Inspection of the incident scene on 11.16.14*

Found: *fragment with grooving found on the surface*

Investigator: (signature) (name illegible) _____

Witnesses: _____

1. (signature)

2. (signature)

Specialist: (signature) (signature)

Date sealed:

Crime reporting journal entry No. _____ 20____

The reverse bears the typefaced package number “0509014” and the order in which the objects are to be placed into and taken out of the bag. The bag opening is sealed.

Package No. 2 is a polymeric bag the face of which bears the image of the Expert Service seal and printed factory markings and lines in the manner of a form partially completed in longhand using blue ink:

Ministry of Internal Affairs of Ukraine Directorate in _____ city, district _____

Description: *Inspection of the incident scene on 11.16.14*

Found: *metal fragment found on the surface*

Investigator: (signature) _____

Witnesses: _____

1. (signature)

2. (signature)

Specialist: (signature) (signature)

Date sealed:

Crime reporting journal entry No. _____ 20____

The reverse bears the typefaced package number “0509016” and the order in which the objects are to be placed into and taken out of the bag. The bag opening is sealed.

Package No. 3 is a polymeric bag the face of which bears the image of the Expert Service seal and printed factory markings and lines in the manner of a form partially completed in longhand using blue ink:

Ministry of Internal Affairs of Ukraine Directorate in _____ city, district _____

Description: *Inspection of the incident scene on 11.16.14*

Found: *metal fragment on the bottom of the mine*

Investigator: (signature) (name illegible) _____

Witnesses: _____

1. (signature)

2. (signature)

Specialist: (signature) (signature)

Date sealed:

Crime reporting journal entry No. _____ 20____

[seal:]

Forensic Research Center No. 12

Kharkiv Region Main Directorate

Ministry of Internal Affairs of Ukraine

[signature] [signature]

Forensic experts

Ye.O. Bosenko

V.M. Hapon

The reverse bears the typefaced package number “1157665” and the order in which the objects are to be placed into and taken out of the bag. The bag opening is sealed.

Package No. 4 is a polymeric bag the face of which bears the image of the Expert Service seal and printed factory markings and lines in the manner of a form partially completed in longhand using blue ink:

Ministry of Internal Affairs of Ukraine Directorate in _____ city, district _____

Description: *Inspection of the incident scene on 11.16.14*

Found: *grey-colored plastic fragment*

Investigator: (signature) (name illegible) _____

Witnesses: _____

1. (signature)

2. (signature)

Specialist: (signature) (signature)

Date sealed:

Crime reporting journal entry No. _____ 20____

The reverse bears the typefaced package number “0508997” and the order in which the objects are to be placed into and taken out of the bag. The bag opening is sealed.

Package No. 5 is a polymeric bag the face of which bears the image of the Expert Service seal and printed factory markings and lines in the manner of a form partially completed in longhand using blue ink:

Ministry of Internal Affairs of Ukraine Directorate in _____ city, district _____

Description: *Inspection of the incident scene on 11.16.14*

Found: *fragments after sifting*

Investigator: (signature) (name illegible) _____

Witnesses: _____

1. (signature)

2. (signature)

Specialist: (signature) (signature)

Date sealed:

Crime reporting journal entry No. _____ 20____

The reverse bears the typefaced package number “0509012” and the order in which the objects are to be placed into and taken out of the bag. The bag opening is sealed.

Package No. 6 is a polymeric bag the face of which bears the image of the Expert Service seal and printed factory markings and lines in the manner of a form partially completed in longhand using blue ink:

Ministry of Internal Affairs of Ukraine Directorate in _____ city, district _____

Description: *Inspection of the incident scene on 11.16.14*

Found: *wire fragment found on the surface*

[seal:]

Forensic Research Center No. 12

Kharkiv Region Main Directorate

Ministry of Internal Affairs of Ukraine

[signature] [signature]

Forensic experts

Ye.O. Bosenko

V.M. Hapon

Investigator: (signature) (name illegible) _____

Witnesses: _____

1. (signature)

2. (signature)

Specialist: (signature) (signature)

Date sealed:

Crime reporting journal entry No. _____ 20____

The reverse bears the typefaced package number “0508999” and the order in which the objects are to be placed into and taken out of the bag. The bag opening is sealed.

Package No. 7 is a polymeric bag the face of which bears the image of the Expert Service seal and printed factory markings and lines in the manner of a form partially completed in longhand using blue ink:

Ministry of Internal Affairs of Ukraine Directorate in _____ **city, district** _____

Description: *Inspection of the incident scene on 11.16.14*

Found: *runoff from the crater*

Investigator: (signature) (name illegible) _____

Witnesses: _____

1. (signature)

2. (signature)

Specialist: (signature) (signature)

Date sealed:

Crime reporting journal entry No. _____ 20____

The reverse bears the typefaced package number “0508996” and the order in which the objects are to be placed into and taken out of the bag. The bag opening is sealed.

The packages have not been disturbed, providing safe storage for the investigated objects and preventing unauthorized access.

Upon opening package No. 1, a metal fragment was retrieved with partial grooving: **investigated object No. 1** (Figures 3,4);

Upon opening package No. 2, a metal fragment was retrieved: **investigated object No. 2** (Figures 5,6);

Upon opening package No. 3, a metal fragment was retrieved: **investigated object No. 3** (Figures 7,8);

Upon opening package No. 4, a fragment made of Bakelite was retrieved: **investigated object No. 4** (Figures 9,10);

Upon opening package No. 5, the following were retrieved:

- Fragment made of Bakelite: **investigated object No. 5.1** (Figure 11);
- Metal fragment with grooving: **investigated object No. 5.2** (Figure 11);
- Flat metal wire fragment – **investigated object No. 5.3** (Figure 11);

[seal:]

Forensic Research Center No. 12

Kharkiv Region Main Directorate

Ministry of Internal Affairs of Ukraine

[signature] [signature]

Forensic experts

Ye.O. Bosenko

V.M. Hapon

- Two metal fragments with magnetic properties: **investigated objects No. 5.4** (Figure 11)

- Metal wire fragment - **investigated object No. 5.5** (Figure 11);

- Cylindrically shaped metal fragment - **investigated object No. 5.6** (Figure 11);

- Five metal fragments - **investigated object No. 5.7** (Figure 11);

Upon opening package No. 6, a metal wire fragment was retrieved: **investigated object No. 6** (Figure 12);

Upon opening package No. 7, two gauze tampons were retrieved: **investigated object No. 7** (Figure 13);

The objects submitted for investigation correspond to their description in the resolution requesting forensic analysis.

Separate investigation of submitted objects

Investigated object No. 1 is a metal fragment measuring 12.5 x 10 mm made of grey metal. One of the sides of the fragment shows deformed grooving.

Investigated object No. 2 is a metal fragment 0.5 mm thick made of grey metal which shows damage in the form of bending, rupture, flattening and cracking in the metal structure. At its largest, the fragment measures 21 x 23 mm.

Investigated object No. 3 is a metal fragment 1.5 mm thick made of grey metal which shows damage in the form of bending, rupture, flattening and cracking in the metal structure. The fragment measures 10 mm at its widest and is 13.5 mm long.

Investigated object No. 4 is a fragment made of Bakelite measuring 9 x 10 mm with uneven edges in the form of a rupture. One of the sides of this fragment shows damage in the form of a split and is partially coated with grey lacquer paint. The other side has an uneven surface revealing a Bakelite structure. The surface of the object shows deposits of a grey substance similar to soot.

Investigated object No. 5.1 is a fragment made of Bakelite measuring 15 x 11 mm with uneven edges in the form of a rupture. One of the sides of this fragment is coated with grey lacquer paint. The other side has a smooth surface and splits revealing a Bakelite structure and brown lacquer paint.

Investigated object No. 5.2 is a fragment which has the shape of a semicircle in the cross-section, possibly part of a cylinder's lateral surface. The fragment is made of grey metal. The object shows deformities in the form of compression and displacement. The outer surface of the fragment has grooving. At its largest the object measures 2.5 mm in wall thickness, 12 mm in length and 10 mm in chord distance.

[seal:]

Forensic Research Center No. 12
Kharkiv Region Main Directorate
Ministry of Internal Affairs of Ukraine
[signature] [signature]

Forensic experts

Ye.O. Bosenko
V.M. Hapon

Investigated object No. 5.3 is a flat metal wire fragment with deformities in the manner of coiling and bending. The object has the following dimensions: thickness - 0.5 mm, length - 47 mm, width – 1.5 mm.

Investigated objects No. 5.4 are two metal fragments with magnetic properties and are shaped like cubes. The outer surface of the fragments has metal parts. When the metal parts are removed, the objects measure 3x3 mm and 4 x 3 mm. The sides of the fragments have an uneven, rough surface with traces of deformation in the form of chipping.

Investigated object No. 5.5 is a metal wire fragment which shows deformation in the manner of a bend. The object measures 1 mm in thickness and 9 mm in length.

Investigated object No. 5.6 is a cylindrically shaped metal fragment measuring 15 mm in height and 11 mm in middle section diameter. The object shows deformation in the form of compression and bending. The lateral surface of the object shows traces of circular grooving.

Investigated objects No. 5.7 are five metal fragments. The objects show deformities in the form of compression, splitting and ruptures.

Investigated object No. 6 is a metal wire fragment showing deformation in the form of flattening and breakage. The object measures 1 mm in thickness and 15 mm in length.

Investigated object No. 7 is two gauze tampons which have deposits on the surface of a grey and brown colored substance.

Comparative investigation [4]

A comparative investigation was conducted to establish whether investigated objects No. 4, 5.1–5.3, 5.5 and 6 can be grouped.

A visual inspection established that the objects have the following exterior characteristics:

- Objects 4 and 5.1 are Bakelite fragments with one side coated with grey lacquer paint;
- Object No. 5.2 is a fragment of a cylinder's lateral surface with grooving on the outer surface;
- Object No. 5.3 is a flat metal wire fragment;
- Object No. 5.5 and 6 are metal wire fragments.

Considering the results obtained, a comparison was made between investigated objects No. 4, 5.1–5.3, 5.5 and 6 and available descriptions [4] of explosive munitions and their fuzes, by juxtaposing identical characteristics. As a result of comparative investigation it was established that objects No. 4 and 5.1 are likely to be casing fragments of a limpet (magnetic) mine. Objects No. 5.2, 5.3, 5.5 and 6 are likely to be fragments of the VZD-1M fuze. Similarity was established in the appearance and structural characteristics. The results of comparison are shown in Figures 1 and 2.

[seal:]

Forensic Research Center No. 12
Kharkiv Region Main Directorate
Ministry of Internal Affairs of Ukraine
[signature] [signature]

Forensic experts

Ye.O. Bosenko
V.M. Hapon



Figure 1. Comparison of investigated objects No. 4 and 5.1 with a limpet (magnetic) mine.



Figure 2. Comparison of investigated objects No. 5.2, 5.3, 5.5 and 6 with a VZD-1M fuze.

Investigated objects No. 5.4 are fragments of a magnet.

Investigated objects No. 1, 2, 3, 5.6 and 5.7 do not have sufficient distinguishing features to be identified with sections, nodes and parts of explosive munitions or other explosive devices.

A chemical investigation (of explosive substances and products of explosion and gunfire) was carried out in order to identify traces of explosive substances and explosion products in the deposits on investigated objects No. 4, 5.1 and 7.

Chemical investigation (of explosive substances and products of explosion and gunfire) [2,3,6]

Morphological investigation (microscopy)

A microscopic investigation was conducted with the naked eye in daylight, as well as using a 4-x magnifying glass and an MSP-1 stereomicroscope

The morphological investigation established the following:

- The surface of investigated objects No. 4 and No. 5.1 has poorly visible deposits of a dark grey amorphous substance (soot);
- The surface of investigated objects No. 7 has deposits of a dark grey amorphous substance (soot) and deposits of a brown substance similar in appearance to rust.

A comparison between the investigated objects and explosive substance samples from the explosive substance collection held by FEAD FRC) at the Main Directorate of the Ministry of Internal Affairs of Ukraine in Kharkiv Region, as well as with data in reference publications, established that the morphological characteristics of the investigated objects are not identical to the characteristics of explosive substances.

Sample preparation

I. Preparing acetone extracts of investigated objects.

Investigated objects were transferred into separate flasks, adding 10 ml of acetone to each, and held for 6 hours with periodic shaking. The solutions obtained were filtered through a paper filter to obtain acetone extracts No. 4a, No. 5.1a and No. 7a as well as respective insoluble residue.

II. Preparing water extracts of investigated objects.

[seal:]

Forensic Research Center No. 12
Kharkiv Region Main Directorate
Ministry of Internal Affairs of Ukraine
[signature] [signature]

Forensic experts

Ye.O. Bosenko
V.M. Hapon

Investigated objects were transferred into separate flasks, adding 15 ml of warm distilled water to each and held for 6 hours with periodic shaking. The solutions obtained were filtered through a paper filter to obtain acetone extracts No. 4a, No. 5.1a and No. 7a as well as respective insoluble residues. After steeping, the substances received were filtered through separate paper filters to obtain respective water extracts No. 4b, No. 5.1b and No. 7b, as well as respective insoluble residues.

Capillary chemical reactions

Qualitative chemical reactions were conducted in order to determine the chemical composition of investigated objects. Investigation followed this algorithm.

I. Qualitative reactions with acetone extracts.

Each acetone extract was divided into four equal aliquots, two of which were subjected to qualitative reactions, and the other two aliquots were used for thin-layer vertical chromatography investigations.

1. Determining organic oxidant compounds (soluble in acetone)

An aliquot of the acetone extract was steamed in a jet of cool air until a dry residue, to which 1 drop was added of a 1% solution of diphenylamine in concentrated sulphuric acid. The appearance of spots and dark-blue jets points to the presence of oxidants.

2. Determining nitroaromatic compounds

An aliquot of the acetone extract was steamed in a jet of cool air until a dry residue, to which 1 drop of acetone was added along with 1 drop of a 1 per cent solution of natrium hydroxide in ethanol. The appearance of red and brown or blue coloring points to the presence of trinitro- or dinitroaromatic compounds, respectively.

3. Qualitative luminescent analysis

In order to determine the possible presence of fuel and lubricants, as well as of objects of a biological nature, investigated objects and respective acetone extracts were inspected in the ultraviolet light of an OLD-41emitter. The inspection involved watching for the presence or absence of luminescence from the acetone extracts of investigated objects.

The results of investigation using the qualitative reactions method are presented in Table 1.

Table 1

Results of investigating acetone extracts of investigated objects using the qualitative reactions method

Extracts	Reaction to		
	Oxidants	Nitroderivatives of aromatic compounds	Presence of luminescence
No. 4a, No. 5.1a, No. 7a	+	+	+

Note to Tables 1 and 2: the + sign denotes a positive test result (the determined component is present); the – sign denotes a negative test result (the determined component is absent).

II. Qualitative reactions with water extracts

One drop of an investigated water extract was entered on strips of a universal indicator paper LACHEMA (PND 50-975-84 pH 0-12), comparing the resulting changes in color to the

[seal:]

Forensic experts Forensic Research Center No. 12
 Kharkiv Region Main Directorate
 Ministry of Internal Affairs of Ukraine
 [signature] [signature] **Ye.O. Bosenko**
V.M. Hapon

standard scale. A yellow-olive color was observed to appear, corresponding to pH=7 (neutral medium). Each water extract was divided into seven aliquots, which were used in the following reactions:

1. Determining of non-organic oxidant compounds (soluble in water)

An aliquot of the water extract was steamed in a jet of cool air until a dry residue, to which 2 drops were added of a 1% solution of diphenylamine in concentrated sulphuric acid. The appearance of spots and dark-blue jets points to the presence of oxidants.

2. Determining nitrite ions and nitrate ions

An aliquot of the water extract was transferred onto a glass plate, steamed in a jet of warm air until a volume of several drops, to which several granules were added of a solid Griess reagent. The appearance of a pink color points to the presence of nitrite ions. Zinc dust was added to the obtained reaction medium. Development and the appearance of a dark red color points to the presence of nitrate ions.

3. Determining ammonium cations

An aliquot of the water extract was transferred to a tube, to which 3 drops of the Nessler reagent were added. The appearance of a red and brown residue or a dark yellow color points to the presence of ammonium cations.

4. Determining potassium cations

An aliquot of the water extract was transferred into a porcelain cup and steamed until a dry residue. The residue was fried for five minutes to release possible ammonia salts which produce a similar reaction with potassium. After cooling, the residue was dissolved in a drop of distilled water, to which 1 drop was added of a saturated sodium hexanitrocobaltate solution oxidated by vinegar acid. The obtained substance was investigated under the microscope: the appearance of a residue in the form of yellow cubes and friends [sic] points to the presence of potassium cations.

5. Determining chlorate anions

An aliquot of the water extract was transferred onto a glass plate, steamed in a jet of warm air until dry, to which 3 drops were added of a 0.1% aniline sulphate solution in sulphuric acid. The appearance of a dark blue color points to the presence of chlorate anions.

6. Determining carbonate anions and sulphate anions

An aliquot of the water extract was transferred into a tube, adding 3 drops of a 5% barium chloride solution in water. The appearance of a white residue points to the presence of carbonate anions and sulphate anions.

Five drops of a 1% hydrochloric acid solution was added to the obtained residue. Subsequent complete dissolution of the residue points to the presence of carbonate anions, gradual partial dissolution of the residue points to a joint presence of carbonate anions and sulphate anions.

7. Determining chloride anions

An aliquot of the water extract was transferred into a tube, adding 3 drops of a 5% silver

[seal:]

Forensic Research Center No. 12
Kharkiv Region Main Directorate
Ministry of Internal Affairs of Ukraine
[signature] [signature]

Forensic experts

Ye.O. Bosenko
V.M. Hapon

nitrate solution in water. The appearance of a white residue points to the presence of chloride anions.

The results of water extract investigation using the qualitative reactions method are presented in Table 2

Table 2

Results of investigating water extracts of investigated objects using the qualitative reactions method

Extracts	Reaction to									
	pH	Oxidants	Nitrite anion	Nitrate anion	Ammonium cation	Potassium cation	Chlorate anion	Carbonate anion	Sulphate anion	Chloride anion
No. 4b, No. 5.1b, No. 7b	=7	-	+	-	-	-	-	-	-	-

Note to Table 2: the + sign denotes a positive test result (the determined component is present); the – sign denotes a negative test result (the determined component is absent).

III. Investigation of residues insoluble in acetone and water

Residues from the prepared samples of investigated objects were transferred onto a glass plate and investigated using an MBS-10 stereomicroscope.

Shapeless black particles were observed under the microscope. The particles do not change under the action of weak and concentrated hydrochloric and sulphuric acid solutions, which makes it possible to identify them as fragments of soot.

Investigation using the thin-layer chromatography method

The method of vertical single-dimension straight-phase thin-layer chromatography (TLC) was used to determine traces of explosive substances and products of their explosive transformation, as well as of stabilizers and components of smoke-free gunpowder in the content of investigated objects.

For this, two parts of acetone extracts obtained in the process of sample preparation were steamed in a jet of cool air until the volume of several microdrops and using a drip were entered onto the start line of chromatographic plates at a distance of 15 mm from the bottom edge of the plate.

I. Chromatography was conducted under these conditions:

- Stationary phase - Sorbfil chromatographic plates PTSX-P-A-UF (TU 26-11-17-89) measuring 10 x 10 cm with the working absorbent layer: silicagel STX-1A (layer thickness: 90...120 nm, grain fraction: 5...17 nm) with a binder based on ciliendumdioxide with the addition of luminophore at 254 nm.
- Mobile phase (eluent) - acetone-toluene-hexane (1:1:2)

[seal:]

Forensic experts
Forensic Research Center No. 12
Kharkiv Region Main Directorate
Ministry of Internal Affairs of Ukraine
[signature] [signature]

Ye.O. Bosenko
V.M. Hapon

Preparatory Stages - eluent cleansing of the 25% ammonia water solution, drying for 30 minutes at 100°C, removing the top and bottom edges of the plate 5 mm thick each and bottom corners 1 mm wide.

Eluent front elevation - 70 mm

Spot detection - Ultraviolet light from an OLD-14 emitter, 5% diphenylamine solution in ethanol, 10% potassium hydroxide solution in ethanol

Reference samples - Acetone extracts of explosive substances

The results of the investigation are presented in Table 3.

Table 3

TLC results in the acetone-toluene-hexane (1:1:2) solvent system

Acetone extract No	Stages of detection					
	Treatment in 5% diphenylamine solution in ethanol		UV treatment		Treatment in 10% potassium hydroxide solution in ethanol	
	Zone coloring	R _f	Zone coloring	R _f	Zone coloring	R _f
Trotyl (TNT)	Yellow-orange	0.78	Orange-brown	0.78	Red-brown	0.78
Tetryl	Dark yellow	0.47	Yellow-orange	0.47	Red	0.47
TEN	Colorless	0.68	Green	0.68	Green	0.68
Hexogen (RDX)	Light grey	0.29	Green-grey	0.29	Blue-grey	0.29
Octagen	Light grey	0.14	Green-grey	0.14	Blue-grey	0.14
Nitroglycerine (acetone extract of dibasic powder)	Colorless	0.42	Green	0.42	Green	0.42
No. 4a; No. 5.1a; No. 7a	Light grey	0.29	Green-grey	0.29	Blue-grey	0.29
	Yellow-orange	0.78	Orange-brown	0.78	Red-brown	0.78

The chromatogram of acetone extracts from investigated objects No. 4, No. 5.1 and No. 7 shows zones with the coloring and chromatographic mobility value R_f (the ratio of the distance traveled by a spot of the investigated compound to the distance traveled by the eluent front) characteristic of hexogen/RDX (R_f – 0.29) and trotyl/TNT (R_f – 0.78).

II. Chromatography was conducted under the following conditions:

Stationary phase - Sorbfil chromatographic plates PTSX-P-A-UF (TU 26-11-17-89) measuring 10 x 10 cm with the working sorbent layer: silicagel STX-1A (layer thickness: 90...120 nm, grain fraction: 5...17 nm) with a binding

[seal:]

Forensic experts
 Forensic Research Center No. 12
 Kharkiv Region Main Directorate
 Ministry of Internal Affairs of Ukraine
 [signature] [signature]

Ye.O. Bosenko
V.M. Hapon

- agent based on ciliciumdioxide with the addition of luminophore at 254 nm.
- Mobile phase (eluent) - acetone-toluene-hexane (1:1:2)
- Preparatory Stages - eluent cleansing of the 25% ammonia water solution, drying for 30 minutes at 100°C, removing the top and bottom edges of the plate 5 mm thick each and bottom corners 1 mm wide.
- Eluent front elevation - 70 mm
- Spot detection - UV light from an OLD-14 emitter, Moiror's reagent
- Reference samples - Acetone extract of diphelynamine

The results of investigation using the thin-layer chromatography method are presented in Table 4

Table 4

TLC results in the acetone-toluene-hexane (1:1:2) solvent system

Object (acetone extract No)	Detection stages			
	UV treatment		Treatment with Moiror's reagent	
	Zone coloring	R _f	Zone coloring	R _f
Reference sample: acetone extract of diphelynamine	Grey	0.78	Blue	0.78
No. 4a; No. 5a; No. 7a	-	-	-	-

Chromatograms of the acetone extracts of investigated objects No. 4, No. 5.1 and No. 7 do not show zones with the coloring and chromatographic mobility value R_f (the ratio of the distance traveled by a spot of the investigated compound to the distance traveled by the eluent front) characteristic of diphelynamine (a stabilizer for smoke-free gunpowder).

Therefore, after summarizing separate investigations conducted, the following has been established:

- 1) According to the results of morphological investigation:
 - the appearance and morphological characteristics of black substances in the form of deposits on the surface of the given objects point to the fact that these deposits are soot;
- 2) the results of the qualitative capillary analysis are presented in Tables 1 and 2;
- 3) the results of investigation using the thin-layer chromatography method established that the content of investigated objects No. 4a, No. 5.1a and No. 7a included trotyl (TNT) and hexogen (RDX).

An evaluation of the summarized results of chemical investigation makes it possible to draw the following conclusions:

- The objects submitted for investigation bear traces of the explosion products of an explosive substance based on trotyl (TNT) and hexogen (RDX).

[seal:]

Forensic experts
 Forensic Research Center No. 12
 Kharkiv Region Main Directorate
 Ministry of Internal Affairs of Ukraine
 [signature] [signature]

Ye.O. Bosenko
V.M. Hapon

In response to the questions: “*Are the objects found at the scene of the incident parts of an explosive device, and if yes, what type of device do they belong to?*”; “*Was the explosion caused by ammunition or an explosive device, and if yes, what type (hand grenades, mortar, shells, etc.?)*” and “*What method was used in this case to cause the explosion?*”

The results of investigation with regard to these objects and materials make it possible to conclude that an explosive device, probably of industrial manufacture, was detonated on the surface of the pipe in the technical mine.

The Bakelite fragments submitted for investigation (investigated objects No. 4 and No. 5.1) are probably remnants of the casing of a limpet (magnetic) mine. Investigated objects No. 5.2, 5.3, 5.5 and 6 are probably fragments of the VZD-1M fuze mechanism. Investigated object No. 5.4 amounts to magnet fragments. Investigated objects No. 1, 2, 3, 5.6 and 5.7 do not bear sufficient distinguishing characteristics to be identified with sections, nodes or parts of explosive ammunition or other explosive devices.

The investigations conducted make it possible to assume that an industrially manufactured detonation device—a fuze—was used, as well as an industrially manufactured explosive device (the above fuze is used as a standard with limpet (magnetic) mines).

The VZD-1M fuze is a delayed-action fuze which after a time lapse set by the time-delay mechanism (one of the metal elements it is usually equipped with).

The remnants of a limpet (magnetic) mine casing submitted for investigation, the VZD-1M fuze fragments and the magnet fragments make it possible to assume that a limpet mine was probably used.

In response to the question “*Do the objects found at the scene of the incident bear traces of explosive substances, and if yes, which ones?*”

Having summarized the results of chemical investigation it is possible to conclude that the objects submitted for investigation bear traces of the explosion products of an explosive substance based on trotyl (TNT) and hexogen (RDX).

Therefore, on the basis of investigations conducted, the following has been established:

- investigated objects No. 4, No. 5.1 and No. 5.4 are probably remnants of a limpet (magnetic) mine (medium limpet mine);
- investigated objects No. 5.2, 5.3, 5.5 and 6 are probably fragments of the VZD-1M fuze mechanism.

Investigated objects No. 1, 2, 3, 5.6 and 5.7 do not bear sufficient distinguishing characteristics to be identified with sections, nodes or parts of explosive ammunition or other explosive devices.

- the objects submitted for investigation bear traces of the explosion products of an explosive substance based on trotyl (TNT) and hexogen (RDX).
- the results of investigation with regard to these objects and materials make it possible to conclude that an explosive device, probably a limpet (magnetic) SPM mine (medium limpet

[seal:]

Forensic Research Center No. 12

Kharkiv Region Main Directorate

Forensic experts

Ministry of Internal Affairs of Ukraine

[signature] [signature]

Ye.O. Bosenko

V.M. Hapon

mine), equipped as a standard with a VZD-1M fuze, was detonated on the surface of the pipe in the technical mine.

- assuming an SPM (medium limpet mine) with a VZD-1M fuze was used, the following detonation method was applied: the VZD-1M fuze is a delayed-action fuze, activating after a time lapse set by the time-delay mechanism inside it (one of the metal elements it is normally equipped with). After a mine is laid on site, the safety catch is pulled out and the wire loop of a spring firing pin begins to slowly cut the metal element. After the metal element has been cut, the released firing pin pierces the capsule detonator of the fuze and the mine explodes.

The following reference sources were used during this expert analysis:

1. "Instructions on the procedure and documentation of forensic analyses," approved by order No. 19/1-272n of the State Forensic Research Center of the Ministry of Internal Affairs of Ukraine dated 10.31.2013
2. V.N. Aginsky, V.I. Golyashin, S.V. Vladimirov "Forensic investigation of explosive substances"/Edited by N.M. Kuzmin, Moscow: All-USSR Research Institute of the Ministry of Internal Affairs of the USSR, 1985, 72 pages.
3. V.N. Aginsky, Yu.M. Dildin "Investigating substances for belonging to explosive materials and pyrotechnic mixtures. Methodological recommendations." – Moscow, Central Forensic Research Laboratory, Ministry of Internal Affairs of the USSR, 1982, 12 pages.
4. "Explosive ammunition." Book 2. Voenizdat, Ministry of Defense of the USSR, Moscow – 1979, 184 pages.
5. G.V. Prokhorov-Lukin, V.I. Bykov, V.I. Pashchenko "Methodology for a comprehensive analysis of explosive devices, explosive substances and traces of explosion." Kyiv, Elite Print, 2011 – 216 pages.
6. V.N. Tsvetkova, L.K. Isayeva "Using thin-layer chromatography and infra-red spectroscopy in investigating certain industrial explosives." "Expert practice and new investigation methods" journal, issue 9, p 7-16. All-USSR Forensic Research Institute, Moscow: 1975.

The following was used during inspection and investigation: MSP-1 stereomicroscopes No. XS 3740, certificate of conformity No. 03/8773; Vernier caliper ShTs-1 (No. 393935), certificate of conformity No. 03/8745; expert magnifying glass; CAS electronic scales of $\pm 1.0g$ precision (No. 98050605), OLD 41 emitter, samples No. 1–50 of explosive substances from the FEAD FRC collection, a set of chemical reagents, Sorbfil plates for thin-layer chromatography (TU 26-11-17-89). The capture and printing of images was done using digital camera Canon Power Shot A 3100 IS, the Intel (R) Celeron (R) PC, CPU 2.8 Hz, 960 GB RPM and laser printer CANON LBP-2900.

The illustrative table from the incident scene provided is appended to the second copy of this expert conclusion.

[seal:]

Forensic Research Center No. 12
Kharkiv Region Main Directorate
Ministry of Internal Affairs of Ukraine
[signature] [signature]

Forensic experts

Ye.O. Bosenko
V.M. Hapon

The investigated objects have been returned to their original packaging. The bag openings are tied with white string, with the loose ends tagged (Figure 14). The tags are made in the manner of a form completed in longhand using blue ink and have a round seal of the “Forensic Research Center No. 12, Kharkiv Region Main Directorate, Ministry of Internal Affairs of Ukraine”:

Expert conclusion No. 577/2014-15

City, district Directorate of the Security Service of Ukraine

Criminal proceedings No. 22014220000000283

RD No. _____

In relation to: blast in Morozov Street

Danger category:

- extremely dangerous

- dangerous

- somewhat dangerous

- safe (highlighted in red)

DANGER: EXPLOSIVE

Sealed: (signature) V.M. Hapon

(seal imprint)

The expert conclusion is appended by an illustrative table, an investigation expenses report and seven packages containing investigated objects.

CONCLUSIONS

1. The objects found at the scene of the incident and submitted for investigation are:
 - investigated objects No. 4, No. 5.1 and No. 5.4 - probably remnants of a limpet (magnetic) mine (medium limpet mine);
 - investigated objects No. 5.2, 5.3, 5.5 and 6 - probably fragments of the VZD-1M fuze mechanism.

Investigated objects No. 1, 2, 3, 5.6 and 5.7 do not bear sufficient distinguishing characteristics to be identified with sections, nodes or parts of explosive ammunition or other explosive devices.
2. The objects submitted for investigation bear traces of the explosion products of an explosive substance based on trotyl (TNT) and hexogen (RDX).
3. The results of investigation with regard to these objects and materials make it possible to conclude that an explosive device, probably a limpet (magnetic) SPM mine (medium limpet mine), equipped as a standard with a VZD-1M fuze, was detonated on the surface of the pipe in the technical mine.
4. Assuming an SPM (medium limpet mine) with a VZD-1M fuze was used, the following detonation method was applied: the VZD-1M fuze is a delayed-action fuze, activating after a time lapse set by the time-delay mechanism inside it (one of the metal elements it is normally equipped with). After a mine is laid on site, the safety catch is pulled out and the wire loop of a spring firing pin begins to slowly cut the metal element. After the metal element has been cut, the released firing pin pierces the capsule detonator of the fuze and the mine explodes.

[seal:]

Forensic Research Center No. 12

Kharkiv Region Main Directorate

Ministry of Internal Affairs of Ukraine

[signature] [signature]

Forensic experts

Ye.O. Bosenko

V.M. Hapon

ILLUSTRATIVE TABLE

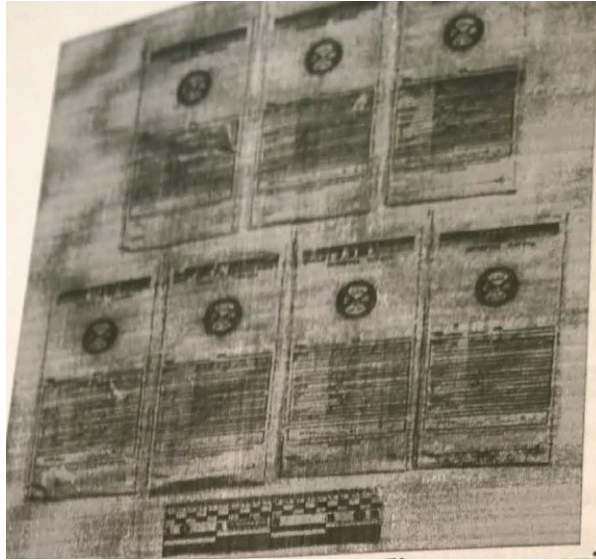

Figure 1 – The appearance of packages No. 1–7 containing investigated objects (front).



Figure 2 – The appearance of packages No. 1–7 containing investigated objects (reverse).

Forensic experts

[seal:]
Forensic Research Center No. 12
Kharkiv Region Main Directorate
Ministry of Internal Affairs of Ukraine
[signature] [signature]

Ye.O. Bosenko
V.M. Hapon

Appendix 1 continued



Figure 3 – the appearance of investigated object No. 1 (side 1)



Figure 4 – the appearance of investigated object No. 1 (side 2)



Figure 5 – the appearance of investigated object No. 2 (side 1)

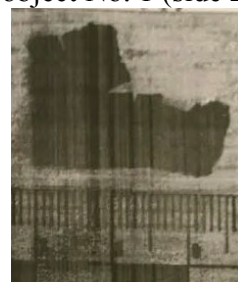

Figure 6 – the appearance of investigated object No. 2 (side 2)



Figure 7 – the appearance of investigated object No. 3 (side 1)

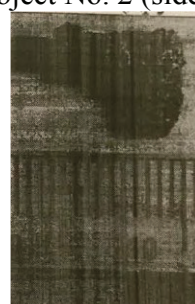

Figure 8 – the appearance of investigated object No. 3 (side 2)



Figure 9 – the appearance of investigated object No. 4 (side 1)



Figure 10 – the appearance of investigated object No. 4 (side 2)

Forensic experts

[seal:]
Forensic Research Center No. 12
Kharkiv Region Main Directorate
Ministry of Internal Affairs of Ukraine
[signature] [signature]

Ye.O. Bosenko
V.M. Hapon

Appendix 1 continued



Figure 11 – the appearance of investigated objects No. 5.1–5.7



Figure 12 – the appearance of investigated object No. 6



Figure 13 – the appearance of investigated object No. 7



Figure 14 – investigated objects in their original packaging and sealed prior to handing over to the client who requested forensic analysis

Forensic experts

[seal:]
Forensic Research Center No. 12
Kharkiv Region Main Directorate
Ministry of Internal Affairs of Ukraine
[signature] [signature]

Ye.O. Bosenko
V.M. Hapon

Annex 113

Expert Opinion No. 64/1-30/6, drafted by Ukrainian Scientific Research Institute for Special Equipment and Forensic Expert Examinations, Security Service of Ukraine
(26 March 2015)

This document has been translated from its original language into English, an official language of the Court, pursuant to Rules of the Court, Article 51.

Pursuant to Rules of the Court Article 51(3), Ukraine has translated only an extract of the original document constituting this Annex. In further compliance with this Rule, Ukraine has provided two certified copies of the full original-language document



SECURITY SERVICE OF UKRAINE
**Ukrainian Scientific Research Institute for Special Equipment
 and Forensic Expert Examinations**
EXPERT OPINION

03/26/2015

City of Kyiv

No. 64/1-30/6

Copy No. 1

We, expert consultants with Section 6 of the 4th Center (Center for Forensic and Special Expert Examinations) of the Ukrainian Scientific Research Institute for Special Equipment and Forensic Expert Examinations of the Security Service of Ukraine – Vitaly Petrovych Stasyuk, with an advanced technical degree, special expert training and experience working as an expert since 2012, holding the qualification of a forensic expert with the right to conduct explosives research with specializations in "Researching Explosive Devices and the Traces and Circumstances of Explosions" (registration certificate No. 477 issued by the Expert Qualification Commission of the Security Service of Ukraine on 03/13/2013) and "Forecasting the Possible Effects of the Use of Explosive Devices and the Traces and Circumstances of Explosions (registration certificate No. 478 issued by the Expert Qualification Commission of the Security Service of Ukraine on 03/13/2013) and an expert consultant with Section 1 of the 4th Center (Center for Forensic and Special Expert Examinations), and Roman Vasylyovych Bilous, with an advanced degree in law, special expert training and experience working as an expert since 1997, holding the qualification of a forensic expert with the right to conduct trace evidence expert examinations with specializations in: "Establishing the Whole from the Parts" (certificate No. 309 issued by the Expert Qualification Commission of the Security Service of Ukraine on 04/15/2008) and "Identifying the Mechanism of Origin of Traces" (certificate No. 310 issued by the Expert Qualification Commission of the Security Service of Ukraine on 04/15/2008) – pursuant to an order calling for a forensic expert criminalistic examination to establish the whole from the parts, issued in the city of Mariupol, Donetsk Region, on 01/17/2015 by Colonel of Justice Ye.L. Kosyak, Deputy Head of the Investigations Department of the Donetsk Regional Directorate of the Security Service of Ukraine, conducted an expert examination based on the files of criminal proceeding No. 2201505000000021.

The experts have been warned of potential liability for presenting knowingly false findings under Article 384 of the Criminal Code of Ukraine:

[signature] *R. Bilous*

[signature] *V. Stasyuk*

[seal:] Security Service of Ukraine, For expert examinations, No. 1

We are aware of the facts of the case from the investigator's order calling for an expert examination.

Together with cover letter No. 56/13-406 nt of 01/20/2015, the Donetsk Regional Directorate of the Security Service of Ukraine provided for expert examination (*according to the cover letter*):

- 2 plastic bags bound with white thread and sealed with a target labeled "Research materials for criminal proceeding 2201505000000021" and signed by the expert;
- 2 envelopes sealed with labels and certified by the expert's signature.

The experts were asked to answer the following questions:

- Did the three metal fragments removed from the crater located 5.5 m from the tree with damaged bark to the east and 12 m from the bus to the east constitute parts of one whole?
- Did the three metal fragments removed from the crater located 5.5 m from the tree with damaged bark to the east and 12 m from the bus to the east and the 6 metal fragments measuring from 14 mm to 65 mm constitute parts of one whole?
- Did the three metal fragments removed from the crater located 5.5 m from the tree with damaged bark to the east and 12 m from the bus to the east, the 6 metal fragments measuring from 14 mm to 65 mm, and the 2 metal objects measuring 10 cm in length and 5 cm in width (the first one) and 40 cm in length and 15 cm in maximum width (the second one) constitute parts of one whole?
- Did the three metal fragments removed from the crater located 5.5 m from the tree with damaged bark to the east and 12 m from the bus to the east, the 6 metal fragments measuring from 14 mm to 65 mm, the 2 metal objects measuring 10 cm in length and 5 cm in width (the first one) and 40 cm in length and 15 cm in maximum width (the second one), and the metal object measuring 25 cm in length and 20 cm in width, with the markings "559-76-6-KZh" and "1237" underneath, constitute parts of one whole?
- Did the objects specified in the previous questions form one whole with the metal cylindrical object measuring 72 cm in length and 12.8 cm in diameter that was sticking out of the ground at a 30° angle in the direction of Mariupol?
- Did the objects specified in the previous questions form one whole with the metal cylindrical object measuring 25.4 cm in length and 12 cm in diameter that was found in crater No. 3, the deformed metal object measuring 63 cm in length and 27 cm in width found to the right of No. 2, and the 2 small deformed metal objects measuring 1) 18 cm in length and 7.4 cm in width, with the marking "E91 B C H" and 2) 22 cm in length and 5.8 cm in width, found near crater No. 2?
- Did the metal cylindrical object measuring 72 cm in length and 12.8 cm in diameter that was sticking out of the ground at a 30° angle in the direction of Mariupol form one whole with the metal cylindrical object measuring 25.4 cm in length and 12 cm in diameter that was found in crater No. 3, the deformed metal object measuring 63 cm in length and 27 cm in width found to the right of crater No. 2, and the 2 small deformed metal objects measuring 1) 18 cm in length and 7.4 cm in width, with the marking "E91 B C H" and 2) 22 cm in length and 5.8 cm in width, found near crater No. 2?
- Did the following objects found and removed during the examination of the bus: to the right of the tool compartment – the metal object that was packed in pack No. 1; on the floor of the

passenger section between rows 2 and 3 – one fragment that was packed in pack No. 2; in the battery compartments – one fragment that was packed in pack No. 3; in the front right corner of the body of the bus – one fragment, packed in pack No. 4; in the lining of the ceiling of the passenger section of the bus, in the left rear section – one fragment, packed in pack No. 5, form one whole with the objects specified in the previous questions, and if so, then which specific objects with which other specific objects?

The following information sources were used in conducting the research:

- *Methods of Complex Analysis of Explosive Devices, Explosive Substances and Traces of Explosions*, Ministry of Justice of Ukraine, Ministry of Internal Affairs of Ukraine, Kyiv 2011;
- *Explosives Expert Book: a Study Guide and Methodological Handbook*, Moscow 2001;
- *BM-21 Combat Vehicle: Technical Description and Operating Instructions*, Ministry of Defense of the USSR, Moscow 1972;
- Granovsky, G.L. *Principles of Trace Evidence Analysis*, Moscow 1974;
- Maylis, N.P. *Forensic Trace Evidence Expert Analysis: a Study Guide and Methodological Handbook for Experts*, Moscow 2000;
- Korukhov, Yu.G. *Trace Evidence Diagnostics*, Moscow 1983;
- *Samples of Expert Opinions. Dactyloscopy, Trace Evidence Analysis, and Expert Examination of Cold Weapons*. Compiled by Ya.V. Rybalko. Kyiv: Editing and Typography of the Ministry of Internal Affairs of the Ukrainian SSR, 1986.

RESEARCH

The objects were received for examination in two plastic packs and two plastic bags. All of the plastic bags were bound with white thread with explanatory notes and the signature of the expert, and the envelopes were sealed with a label and the expert's signature (*Illustrations Nos. 1 and 9, Table No. 1, Illustrations Nos. 1 and 2, Table No. 2*).

The following were used in conducting the research:

- Canon IXUS 145 camera;
- WeiHeng electronic scales;
- caliper ShTs-1 GOST 166-89;
- metal ruler GOST 427-75;
- S-line tape measure, 2m.

The packing precludes access to the contents and is undamaged.

Upon being opened, the packs were found to contain:

Pack No. 1, white plastic bag (Illustration No. 1, Table No. 1);

- grey metal object of irregular shape measuring: 605 x 4 x 125 mm (Object A, Illustration No. 3, Table No. 1);

- grey, deformed cylindrical metal object measuring 250 mm in length, 4 mm in thickness and 200 mm in maximum width (object No. C, Illustration No. 5, Table No. 1);
- grey, semispherical metal object measuring: 99 x 4 x 57 mm (Object B, Illustration Nos. 3 and 4, Table No. 1);
- grey, irregular-shaped metal object measuring: 380 mm in length, 45-115 mm in width, and 3-6.6 mm in thickness (Object No. E, Illustration No. 7, Table No. 1);
- grey, cylindrical metal object measuring: 735 mm in length, ~127 mm in diameter, and 4 mm in thickness (Object No. F, Illustration No. 8, Table No. 1).

Pack No. 2, green plastic bag (Illustration No. 9, Table No. 1):

- grey, irregular-shaped metal object with the following maximum measurements: 690 x 4.7 x 350 mm (Object No. G, Illustration No. 10, Table No. 1);
- grey, irregular-shaped non-magnetic metal object measuring: 185 x 3.2 x 77 mm (Object No. J, Illustration No. 13, Table No. 1);
- grey, cylindrical metal object measuring: 250 mm in length, 116 mm in maximum diameter and 3-6.2 mm in thickness (Object No. H, Illustration Nos. 11-12, Table No. 1);
- grey, irregular-shaped non-magnetic metal object measuring: 175 x 3.2 x 77 mm (Object No. I, Illustration No. 11-12, Table No. 1).

Paper envelope No. 1, sealed with the label "Research materials for expert opinion No. 74 (5 metal fragments) packed by V. Kocherhin", contained metal fragments of various shapes (Illustration No. 1, Table No. 2):

- Object No. 1, Table No. 2, Illustration No. 4, irregular-shaped metal fragment measuring 13 x 1.2 x 8 mm and weighing 0.51 g.
- Object No. 2, Table No. 2, Illustration No. 5, irregular-shaped metal fragment measuring 15 x 1.6 x 11 mm and weighing 2.04 g.
- Object No. 3, Table No. 2, Illustration No. 8, irregular-shaped metal fragment measuring 14 x 1.1 x 6 mm and weighing 0.69 g.
- Object No. 4, Table No. 2, Illustration No. 9, diamond-shaped metal fragment measuring 15 x 1.6 x 20 mm and weighing 2.33 g.
- Object No. 5, Table No. 2, Illustration No. 11, irregular-shaped metal fragment measuring 13 x 1.6 x 14 mm and weighing 2.16 g.

Paper envelope No. 2, labeled "No. 63 by post No. 5 of the State Traffic Inspectorate of the Ministry of Internal Affairs of Ukraine", contained metal fragments of various shapes (Illustrations Nos. 2 and 3):

- Object No. 6, Table No. 2, Illustration No. 3, dark grey irregular-shaped metal object measuring: 17 x 2.5 x 14 mm and weighing 2.26 g;

- Object No. 7, Table No. 2, Illustration No. 3, dark grey irregular-shaped metal object measuring: 13 x 2.5 x 15 mm and weighing 2.31 g;
- Object No. 8, Illustration No. 3, dark grey irregular-shaped metal object measuring: 14 x 2.5 x 14 mm and weighing 2.45 g;
- Object No. 9, Table No. 2, Illustration No. 3, dark grey irregular-shaped metal object measuring: 14 x 2.5 x 15 mm and weighing 2.5 g;
- Object No. 10, Table No. 2, Illustration No. 3, dark grey irregular-shaped metal object measuring: 19 x 2.5 x 23 mm and weighing 3.08 g;
- Object No. 11, Table No. 2, Illustration No. 3, dark grey irregular-shaped metal object measuring: 65 x 4.7 x 19 mm and weighing 20.4 g.

Object No. D, measuring 22 cm in length and 4.7 cm in maximum width, was separated from Object No. C in the process of removing soil from the latter. All of the metal fragments (Objects Nos. A, B, C, D, E, F, G, H, I, J, and K) submitted for examination are made of grey magnetic metal (except Objects Nos. I and J (Table No. 1, Illustrations Nos. 11-13)) and show signs of deformation. Traces of thermal influence can be seen on the objects in the form of chaotically spaced cavities of irregular shape with fire-damaged edges and black stratification (which appears to be soot).

In order to answer the questions that were posed to the experts, a comparative analysis was conducted using the method of juxtaposing and aligning the deformed Objects Nos. A, B, C, D, E, F, G, H, I, J, and K (Table No. 1, Illustrations Nos. 3-14) and Objects Nos. 1-11 (Table No. 2, Illustrations Nos. 1 and 3) and grouping them by features. As a result, a match was found between: Objects Nos. A and B (Table No. 1, Illustration No. 16) Objects Nos. C and E (Table No. 1, Illustration No. 15) based on their general (color, magnetic properties, shape, presence of concentric score marks on the surface of the objects, and serrations) and special (configuration of the separation line edges, shape and order of alternation of protrusions and indentations along the separation line) characteristics. The identified matches indicate that Objects Nos. A and B previously formed one whole and Objects Nos. C and E previously formed one whole, specifically two fragments of the rocket portion of an M-21 OF rocket-propelled shell.

As for the other submitted objects, they were divided into the following groups based on their general characteristics (color, magnetic properties, shape, presence of concentric score marks on the surface of the objects, and serrations):

- group No. 1: Objects Nos. D, F, G, and K are fragments of the rocket portion of a 122-mm unguided M-21 OF rocket-propelled high-explosive fragmentation shell (item 9M22U);
- group No. 2: Objects Nos. H, (I) and J are components of the stabilizer unit of a 122-mm unguided M-21 OF rocket-propelled high-explosive fragmentation shell (item 9M22U);

- group No. 4: Objects Nos. 2 and 4-10 are standard fragmentation elements (preformed fragments) of a 122-mm unguided M-21 OF rocket-propelled high-explosive fragmentation shell (item 9M22U);

- group No. 5: Objects Nos. 1, 3 and 11 are fragmentation elements from the body of a 122-mm unguided M-21 OF rocket-propelled high-explosive fragmentation shell (item 9M22U).

In comparing the submitted research objects indicated above within the discrete groups and objects of group No. 1 with the isolated whole parts identified in the course of the research – Objects Nos. A and B and Objects Nos. C and E – it was not possible to determine whether they formed one whole. This is due to the absence of shared separation lines among these objects and the significant thermal deformation of the objects' edges.

The results of the conducted research give us grounds to conclude that:

- Objects Nos. A and B previously formed one whole and Objects Nos. C and E previously formed one whole, specifically two fragments of the rocket portion of an M-21 OF rocket-propelled shell;

- it was not possible to determine whether Objects Nos. D, F, G, and K, which are fragments of the rocket portion of a M-21 OF rocket-propelled shell, formed one whole due to the absence of shared separation lines among these objects and the significant thermal deformation of the objects' edges;

- it was not possible to determine whether Objects Nos. H (I) and J, which are components of an RS-21 stabilizer unit, formed one whole due to the absence of shared separation lines among these objects and the significant thermal deformation of the objects' edges;

- it was not possible to determine whether Objects Nos. 2 and 4-10, which are standard fragmentation elements (preformed fragments) of a 122-mm unguided M-21 OF rocket-propelled high-explosive fragmentation shell (item 9M22U), formed one whole due to:

1) the absence of shared separation lines among these objects and the significant thermal deformation of the objects' edges;

2) the explosion of one 122-mm unguided M-21 OF rocket-propelled high-explosive fragmentation shell producing 1,640 preformed fragments;

- it was not possible to determine whether Objects Nos. 1, 3 and 10, which are fragments from the body of a 122-mm unguided M-21 OF rocket-propelled high-explosive fragmentation shell (item 9M22U), form one whole due to:

1) the absence of shared separation lines among these objects and the significant thermal deformation of the objects' edges;

2) the explosion of one 122-mm unguided M-21 OF rocket-propelled high-explosive fragmentation shell producing 2,280 fragments from the body of the shell.

Exhibit: Illustration tables Nos. 1 and 2 (10 pages)

The research materials were transferred to the 8th laboratory of the 4th Center of the Institute for Special Equipment and Forensic Expert Examinations of the Security Service of Ukraine for further research.

CONCLUSIONS

- Objects Nos. A and B previously formed one whole and Objects Nos. C and E previously formed one whole, specifically two fragments of the rocket portion of an M-21 OF rocket-propelled shell;

- it was not possible to determine whether Objects Nos. D, F, G, and K, which are fragments of the rocket portion (body) of a M-21OF rocket-propelled shell, formed one whole due to the absence of shared separation lines among these objects and the significant thermal deformation of the objects' edges;

- it was not possible to determine whether Objects Nos. H (I) and J, which are components of an RS-21 stabilizer unit, formed one whole due to the absence of shared separation lines among these objects and the significant thermal deformation of the objects' edges;

- it was not possible to determine whether Objects Nos. 2 and 4-10, which are standard fragmentation elements (preformed fragments) of a 122-mm unguided M-21 OF rocket-propelled high-explosive fragmentation shell (item 9M22U), formed one whole due to:

1) the absence of shared separation lines among these objects and the significant thermal deformation of the objects' edges;

2) the explosion of one 122-mm unguided M-21 OF rocket-propelled high-explosive fragmentation shell producing 1,640 preformed fragments;

- it was not possible to determine whether Objects Nos. 1, 3 and 10, which are fragments from the body of a 122-mm unguided M-21 OF rocket-propelled high-explosive fragmentation shell (item 9M22U), form one whole due to:

1) the absence of shared separation lines among these objects and the significant thermal deformation of the objects' edges;

2) the explosion of one 122-mm unguided M-21 OF rocket-propelled high-explosive fragmentation shell producing 2,280 fragments from the body of the shell.

Experts: [signature] R. Bilous
[signature] V. Stasyuk
[seal:] Security Service of Ukraine, For expert examinations, No. 1

[stamp:] Ukrainian Scientific Research Institute for Special Equipment and Forensic Expert Examinations of the Security Service of Ukraine, Ref. No. 18/4-2196, 03/26/2015, [text cut off]

**SECURITY SERVICE OF UKRAINE
TABLE OF ILLUSTRATIONS No. 1
TO EXPERT OPINION No. 64/1-30/6 of 03/26/2015**

The numbering that was used in the research is placed on the photos of the objects.

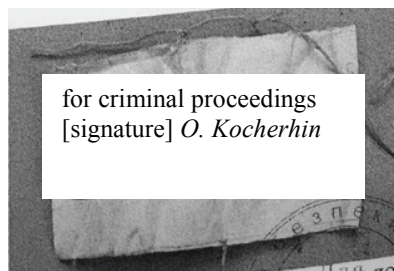
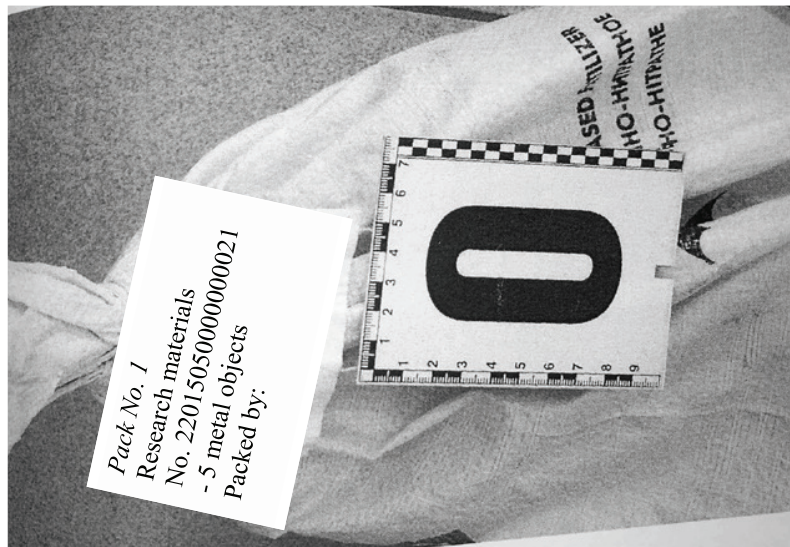
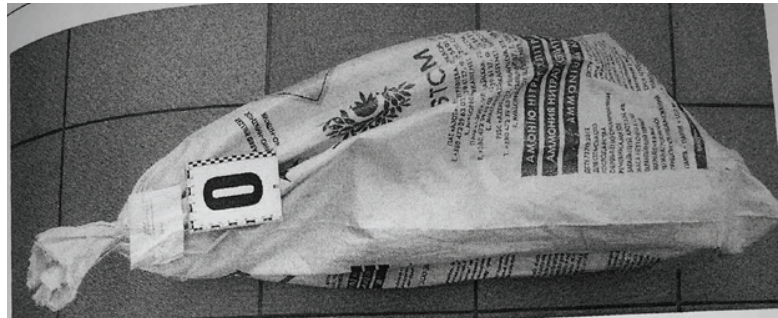

Illustration 1: External view of packaging of material evidence (bag) No. 1.

Experts: [signature] V. Stasyuk
[signature] R. Bilous

[signature] [seal:] Security Service of Ukraine, For expert examinations, No. 1

**SECURITY SERVICE OF UKRAINE
TABLE OF ILLUSTRATIONS No. 1
TO EXPERT OPINION No. 64/1-30/6 of 03/26/2015**

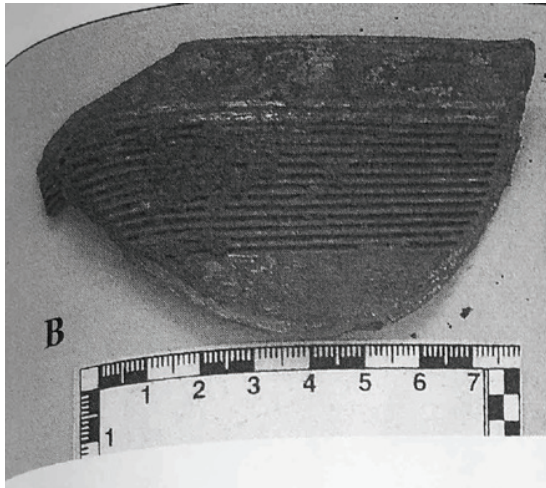

Illustration 4. Contents of pack (bag) No. 1



Illustration 5. Contents of pack (bag) No. 1



Illustration 6. Contents of pack (bag) No. 1 after removal of soil

Experts: [signature] V. Stasyuk
[signature] R. Bilous

[signature] [seal:] Security Service of Ukraine, For expert examinations, No. 1

**SECURITY SERVICE OF UKRAINE
TABLE OF ILLUSTRATIONS No. 1
TO EXPERT OPINION No. 64/1-30/6 of 03/26/2015**



Illustration 7. Contents of pack (bag) No. 1

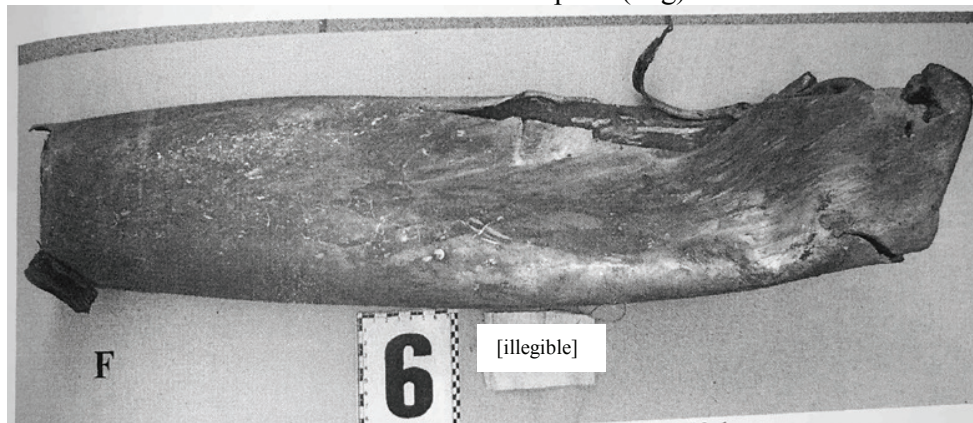

Illustration 8. Contents of pack (bag) No. 1

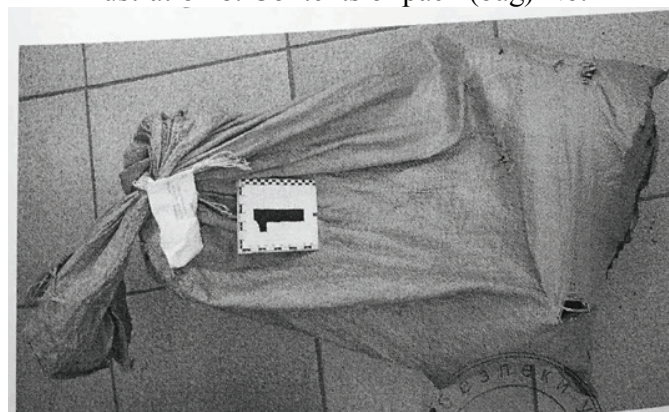

Illustration 9. External view of packing of physical evidence (bag) No. 2

Experts:

[signature] V. Stasyuk
[signature] R. Bilous

[signature] [seal:] Security Service of Ukraine, For expert examinations, No. 1

**SECURITY SERVICE OF UKRAINE
TABLE OF ILLUSTRATIONS No. 1
TO EXPERT OPINION No. 64/1-30/6 of 03/26/2015**

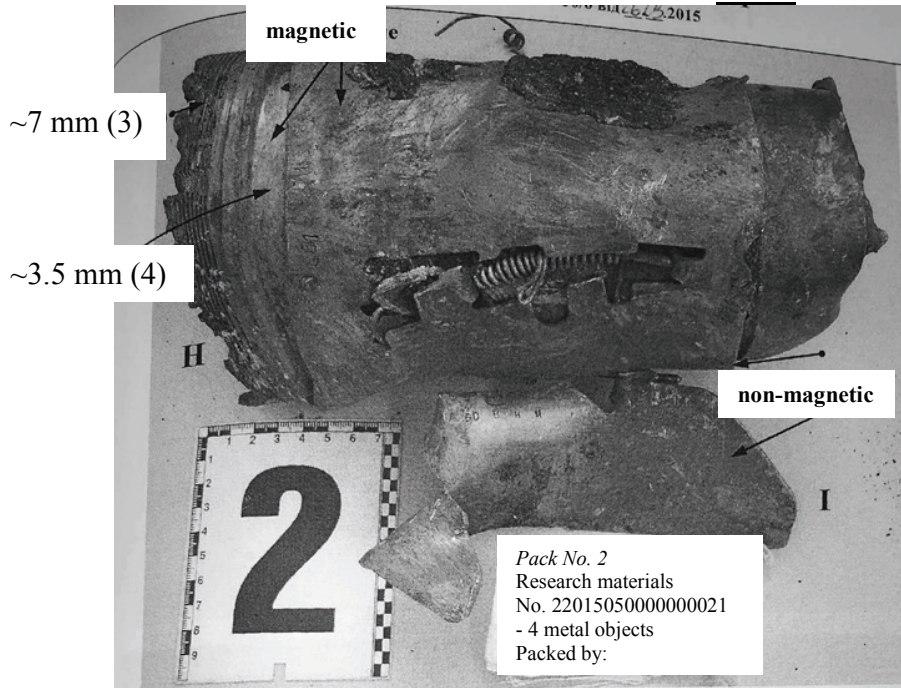

Illustration 12. Contents of pack (bag) No. 2

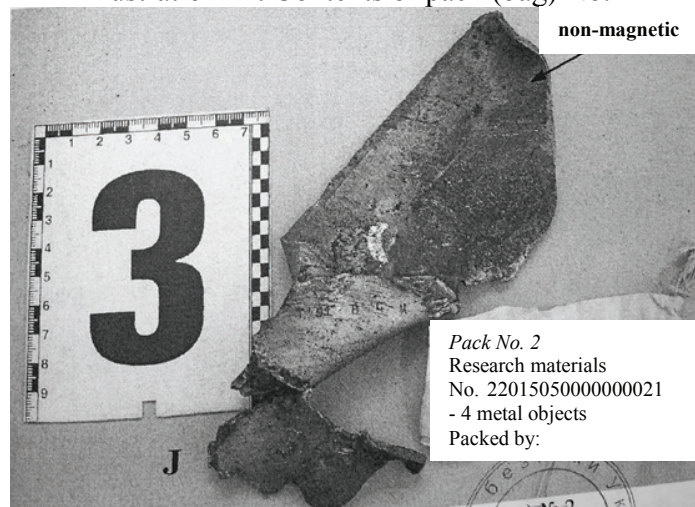

Illustration 13. Contents of pack (bag) No. 2

Experts:

[signature] V. Stasyuk
[signature] R. Bilous

**SECURITY SERVICE OF UKRAINE
TABLE OF ILLUSTRATIONS No. 1
TO EXPERT OPINION No. 64/1-30/6 of 03/26/2015**

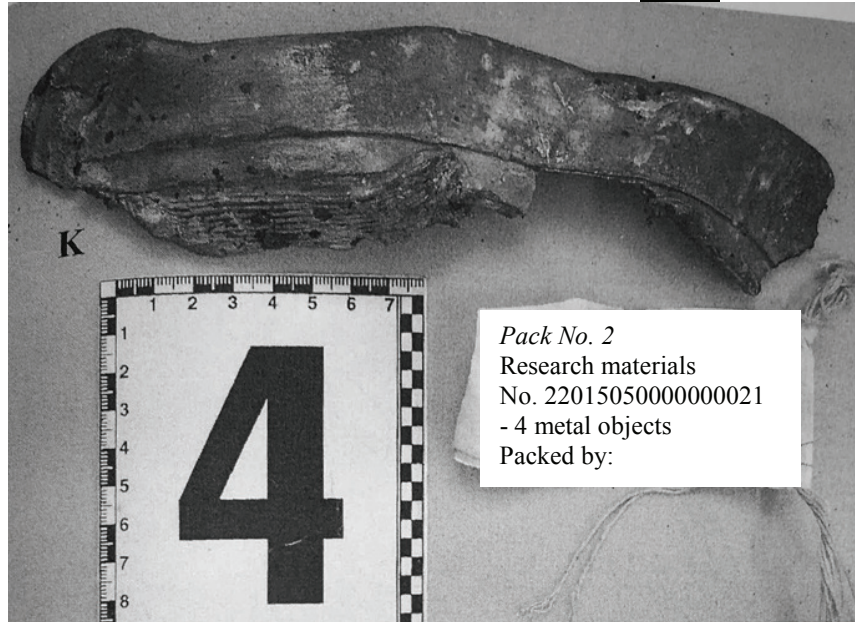

Illustration 14. Contents of pack (bag) No. 2

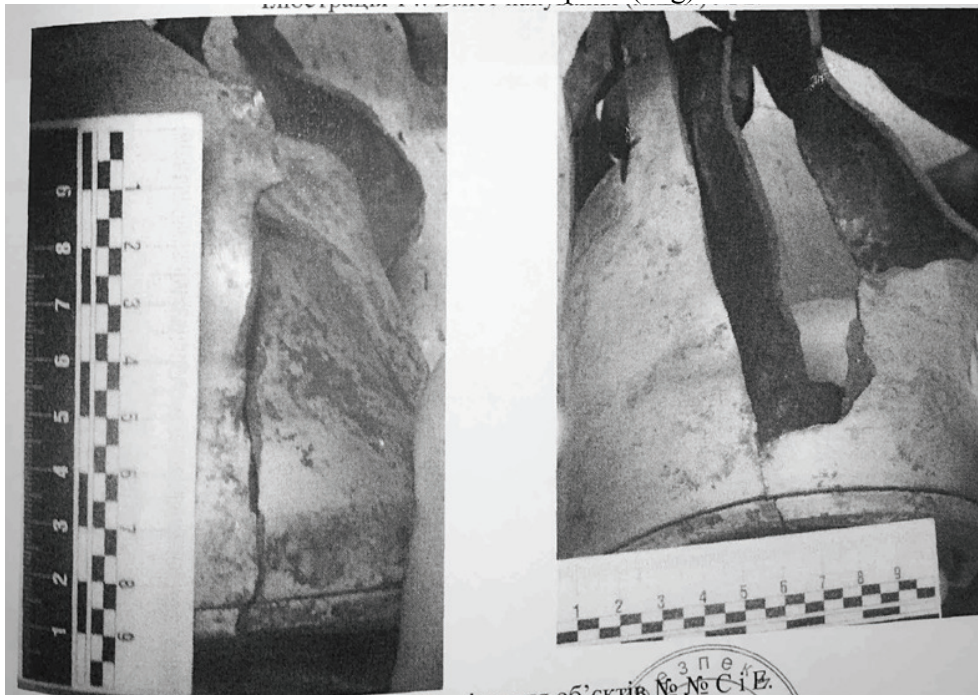

Illustration 15. Comparison of Objects Nos. C and E

Experts:

[signature] V. Stasyuk
[signature] R. Bilous

[signature] [seal:] Security Service of Ukraine, For expert examinations, No. 1

**SECURITY SERVICE OF UKRAINE
TABLE OF ILLUSTRATIONS No. 1
TO EXPERT OPINION No. 64/1-30/6 of 03/26/2015**



Illustration 16. Comparison of Objects Nos. A and B

Experts:

[signature] V. Stasyuk
[signature] R. Bilous

[signature] [seal:] Security Service of Ukraine, For expert examinations, No. 1

**SECURITY SERVICE OF UKRAINE
TABLE OF ILLUSTRATIONS No. 2
TO EXPERT OPINION No. 64/1-30/6 of 03/26/2015**

2. Objects collected outside the epicenters of the explosions

The numbering that was used in the research is placed on the photos of the objects

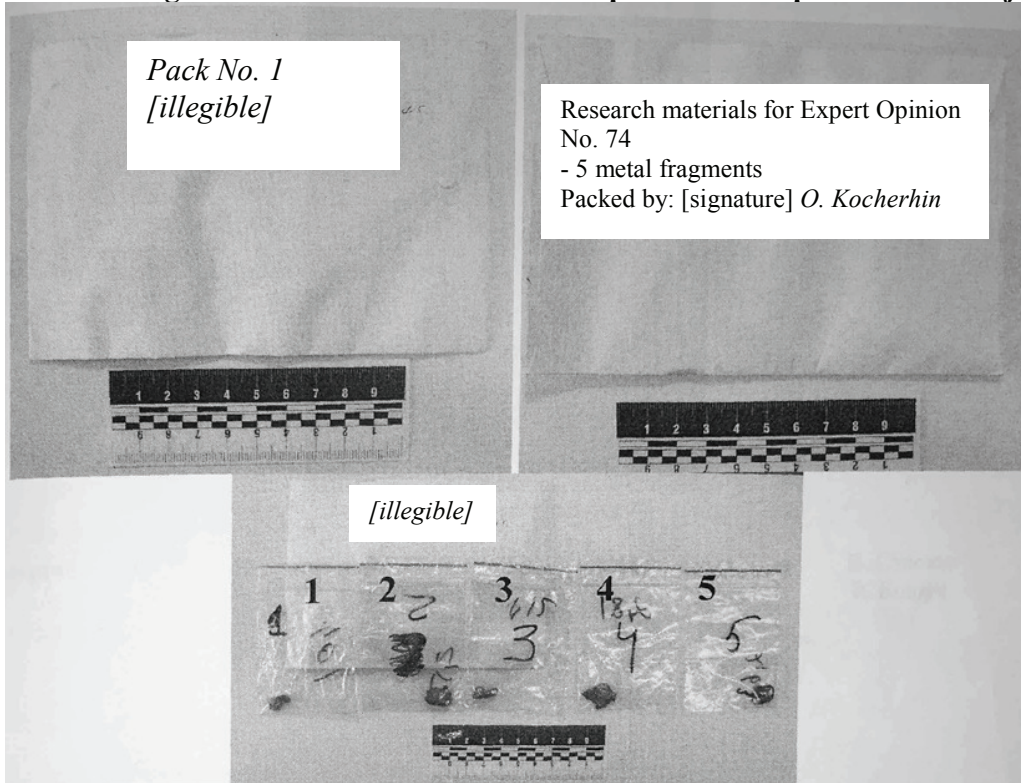

Illustration 1. External view of packaging of material evidence and contents of pack No. 1

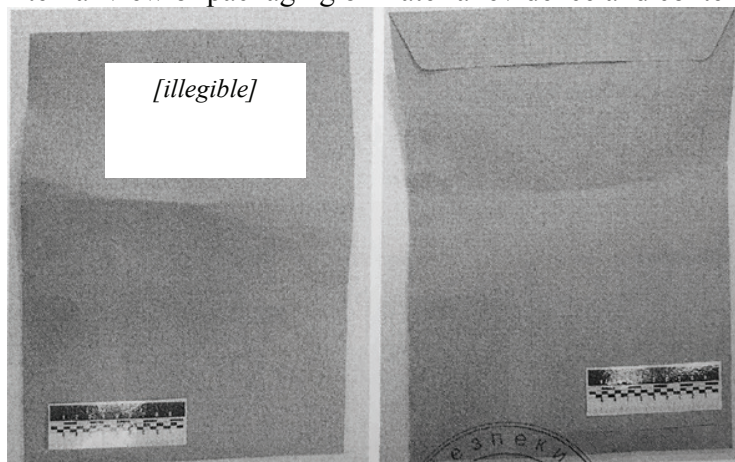

Illustration 2. External view of packaging of material evidence and contents of pack No. 3

Experts: [signature] V. Stasyuk
[signature] R. Bilous

[signature] [seal:] Security Service of Ukraine, For expert examinations, No. 1

**SECURITY SERVICE OF UKRAINE
TABLE OF ILLUSTRATIONS No. 2
TO EXPERT OPINION No. 64/1-30/6 of 03/26/2015**

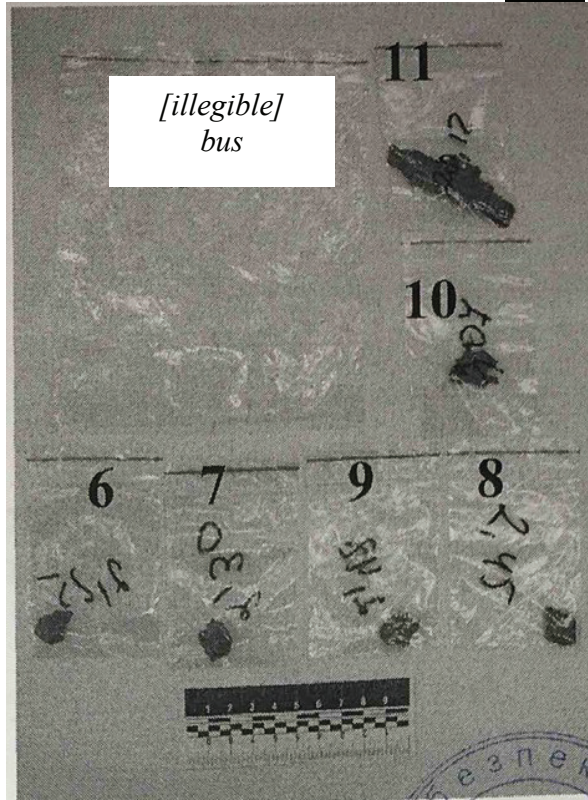

Illustration 3. Contents of pack No. 3

Experts:

[signature] V. Stasyuk
[signature] R. Bilous

Annex 114

Administrative Directorate of the General Staff of the Armed Forces of Ukraine
Letter No. 300/1/C/1640 (28 March 2015)

This document has been translated from its original language into English, an official language of the Court, pursuant to Rules of the Court, Article 51.

Pursuant to Rules of the Court Article 51(3), Ukraine has translated only an extract of the original document constituting this Annex. In further compliance with this Rule, Ukraine has provided two certified copies of the full original-language document



GENERAL STAFF OF THE ARMED FORCES OF UKRAINE

6 Povitroflotsky Prospect, Kyiv-168, Ukraine
Phone: (044) 234-01-92. Fax: (044) 226-26-56

Administrative Directorate of the General
Staff of the Armed Forces of Ukraine

Foreign Ministry of Ukraine

No. 300/1/C/1640 of March 28, 2015

1:45:20 PM Page: 1/5



03071320581898846557

In pursuance of Instruction No. 02-01/2948 of October 15, 2014 issued by the Ukrainian Presidential Chief of Staff, presented herewith are informational reference materials pertaining to the body of evidence for the presence of foreign military groups in Ukrainian territory, to be used in raising the awareness of Ukrainian society and international partners more actively and in the future lawsuits to be filed by Ukraine with the relevant international courts.

Attachment: above-mentioned information on 5 pages, unclassified, for the specified recipient only

Acting First Deputy Chief
of the General Staff of the Armed Forces of Ukraine

Lieutenant General

[Signature]

I.I. KOLESNYK

FOREIGN MINISTRY OF UKRAINE
DEPARTMENT OF THE GENERAL
SECRETARIAT
Incoming Ref. No. 27858
April 1, 2015

O.M. Chekurda, 454-40-78

000438*

Order 210-2014

[...]

II. Regarding the chronology of the crossing of the state border of Ukraine by personnel, weapons, and military vehicles of the Armed Forces of the Russian Federation

No.	Date	Border crossing point crossed	Point of destination (crossing)	Number of convoys	Number of vehicles (personnel)
1	March 25	CHERVONOPARTYZANSK	SVERDLOVSK (premises of a mechanical repair plant)		three tanks and three tanker trucks;
2	March 25	DMYTRIVKA	into the area of STEPANIVKA		20 KamAZ trucks with ammunition.
3	March 23	CHERVONOPARTYZANSK	SVERDLOVSK	1	8 122-mm GRAD multiple rocket launchers
4	March 23	from the Russian Federation	KRASNODON railway station	Train	20 freight cars with munitions and ammo.
5	March 22	DMYTRIVKA	STEPANIVKA	1	30 KamAZ trucks and 5 tanker trucks.
6	March 22	IZVARYNE	LUHANSK	1	12 trucks with munitions and ammo
7	March 21	IZVARYNE	LUHANSK	1	10 trucks with munitions and ammo;
8	March 21	DMYTRIVKA	STEPANIVKA	1	10 tanks, 20 trucks, 10 tanker trucks
9	March 20	IZVARYNE	KRASNODON	1	20 tanks and armored fighting vehicles.
10	March 19	From the Russian Federation	SVERDLOVSK	1	The arriving convoy consisted of 130 personnel, 13 Grad multiple rocket launchers, 9 tanks, and 11 BTR armored personnel carriers.
11	March 19	DMYTRIVKA	STEPANIVKA	1	Convoy of military vehicles (20 T-72 tanks, 60 Ural tarpaulin trucks, and 20 high-capacity tanker trucks).
12	March 19	IZVARYNE, USPENKA	LUHANSK, DONETSK	2	"Humanitarian Convoys" consisting of 81 and 92 trucks (including 20 tanker trucks per convoy).

Acting Chief
of the Main Command Center of the Armed Forces of Ukraine

Major General

[Signature]

B.V. BONDAR

Annex 115

Expert Opinion No. 142, drafted by the Ukrainian Scientific Research Institute of Special Equipment and Forensic Expert Examination, Security Service of Ukraine
(30 March 2015)

This document has been translated from its original language into English, an official language of the Court, pursuant to Rules of the Court, Article 51.

Pursuant to Rules of the Court Article 51(3), Ukraine has translated only an extract of the original document constituting this Annex. In further compliance with this Rule, Ukraine has provided two certified copies of the full original-language document



SECURITY SERVICE OF UKRAINE
Ukrainian Scientific and Research Institute for Special Equipment
and Forensic Expertise
EXPERT OPINION

3/30/2015

City of Mariupol

No. 142

Counterpart No. I

We, Serhiy Vitaliyovych Zholak, chief specialist (expert) of Section 6, Center 4 (Center for Forensic and Special Expertise), of the Ukrainian Scientific and Research Institute for Special Equipment and Forensic Expertise of the Security Service of Ukraine, higher technical education, special expert training and experience working as an expert since 2002, qualified forensic expert with the right to conduct explosives expert examinations with specializations in “Studying explosive devices, traces and the circumstances of explosions” (Certificate No. 503 issued by the Examination and Qualification Commission of the Security Service of Ukraine on 11/28/2013) and “Predicting the potential consequences of using explosive devices” (Certificate No. 504, issued by the Examination and Qualification Commission of the Security Service of Ukraine on 11/28/2013), and Ivan Hryhorovych Borozenets, chief specialist (expert) of Section 6, Center 4 (Center for Forensic and Special Expertise), of the Ukrainian Scientific and Research Institute for Special Equipment and Forensic Expertise of the Security Service of Ukraine, higher technical and legal education, special expert training and experience working as an expert since 2013, qualified forensic expert with the right to conduct explosives examinations with specializations in “Studying explosive devices, traces and the circumstances of explosions” (Certificate No. 481 issued by the Examination and Qualification Commission of the Security Service of Ukraine on 3/13/2013) and “Predicting the potential consequences of using explosive devices” (Certificate No. 482, issued by the Examination and Qualification Commission of the Security Service of Ukraine on 3/13/2013), pursuant to the Order on the Commissioning of an Explosives Expert Examination dated 2/25/2015, issued in the city of Mariupol by Senior Lieutenant O.V. Starostenko, a senior criminal investigator with the Investigations Department of the Donetsk Regional Directorate of the Security Service of Ukraine, carried out an expert examination based on the files of criminal proceeding No. 22015050000000047.

We are familiar with the facts of the case from the order on commissioning an expert examination.

Together with Letter No. 56/13-1029nt of 2/26/2015 (incoming ref. No. 840nt of 2/26/2015), the following items were received for examination.

- 72 large metal fragments bearing paper labels with an explanatory note and 46 small metal fragments, packed into a bag and sealed with a paper label, which were recovered by officers of the State Emergency Service during their inspection of the territory, residential and non-residential buildings of the Skhidnyi microdistrict, Ordzhonikidze District, City of Mariupol after the shelling on 1/24/2005.

[signature] [signature]

The expert panel was asked to answer the following questions:

- Are the 72 large and 46 small metal fragments recovered during the inspection of the territory, residential and non-residential buildings of the Skhidnyi microdistrict, Ordzhonikidze District, City of Mariupol, after the shelling on 1/24/2015, which were submitted for examination, components of munitions? If so, then which munitions exactly?
- Do the objects recovered during the inspection of the territory, residential and non-residential buildings of the Skhidnyi microdistrict, Ordzhonikidze District, City of Mariupol, after the shelling on 1/24/2015, which were submitted for expert examination, bear any markings that make it possible to identify the type and sort of munitions, or any other identifying marks of munitions?
- Is it possible to identify the type and sort of weapon (artillery system or other type of armament) that was used to fire the munitions, fragments of which were submitted for examination? If so, then from which type and sort of weapon were they fired?
- Based on the characteristics of the recovered objects, was there a detonation of munitions fired from an artillery system or other type of weapon, or a detonation of stationary, planted munitions or explosive devices (in the latter case, which type or sort of stationary, planted munitions or explosive devices)?
- Which of the fragments submitted for examination are fragments of munitions (explosive devices), and what is the purpose of each component of the munitions (explosive devices), fragments of which were submitted for examination?

The following information sources were used in conducting the expert examination:

- *“Methods of Complex Examination of Explosive Devices, Substances and Traces” (H.V. Prokhorov-Lukin, V.I. Pashchenko, V.I. Bykov, et al – Kyiv: Elite Print LLC, 2011 – 216 pp.: ill.);*
- *“Mass Produced Explosive Devices and Their Forensic Examination” (Yu.M. Dildin, V.V. Martynov, Expert Consulting Center of the Ministry of Internal Affairs of the Russian Federation. Moscow. 1991);*
- *“Explosives Expert Book: a Study Guide and Methodological Handbook” (Moscow 2001);*
- *“Tables of Fire from M-21-OF High-Explosive Fragmentation Rocket-Propelled Shells (Ministry of Defense of the USSR, Moscow 1975).*
- *“Technical Description. BM-21 Combat Vehicle (Ministry of Defense of the USSR, Moscow 1971).*

The experts have been warned of the potential liability for presenting knowingly inaccurate findings and for refusing without a valid reason to perform their duties under Articles 384 and 385 of the Criminal Code of Ukraine.

_____ [signature] S. Zholak

_____ [signature] I. Borozenets

EXAMINATION

The items submitted for examination were packed in accordance with the rules for the storage and transportation of physical evidence.

The examination was conducted visually under laboratory conditions in daylight at an air temperature of +20 °C.

The following instruments and devices were used:

- caliper No. 51207638
- metal ruler GOST 427-56;
- forensic tape measure SV-1
- magnifying glass with 4x magnification;
- OLYMPUS x-775 camera;

The items submitted for examination were packed in accordance with the forensic rules for the storage and transportation of physical evidence.

The subject matter of the examination consists of metal fragments of irregular and cylindrical shape. All of the fragments show signs of deformation: metal tearing, indentations and scratches. For the sake of convenience, the metal fragments were assigned numbers from 1 to 72. The inspection revealed that the metal fragments have the following dimensions:

- metal object of deformed cylindrical shape with torn edges, gray in color, measuring 770 x 250 x 4 mm (object No. 1, illustration No. 1);
- metal object of deformed cylindrical shape with torn edges, gray in color, measuring 710 x 220 x 4 mm (object No. 2, illustration No. 1);
- metal object of deformed cylindrical shape with torn edges, gray in color, measuring 740 x 420 x 4 mm (object No. 3, illustration No. 1);
- metal object of irregular shape, gray in color, measuring 380 mm in length, 45–115 mm in length, and 3–6.6 mm in thickness (object No. 4, illustration No. 2);
- metal object of deformed cylindrical shape with torn edges, gray in color, measuring 790 x 130 x 4 mm (object No. 5, illustration No. 2);
- metal object of deformed cylindrical shape with torn edges, gray in color, measuring 730 x 180 x 4 mm (object No. 6, illustration No. 2);
- metal object of deformed cylindrical shape with torn edges, gray in color, measuring 660 x 220 x 4 mm (object No. 7, illustration No. 3);
- metal object of deformed cylindrical shape (flattened cylinder) with torn edges, gray in color, measuring 820 x 180 x 4mm (object No. 8, illustration No. 3);
- metal object of deformed cylindrical shape with torn edges, gray in color, measuring 440 x 290 x 4 mm (object No. 9, illustration No. 3);
- metal object of deformed cylindrical shape with torn edges, gray in color, measuring 900 x 180 x 4 mm (object No. 10, illustration No. 4);
- metal object of deformed cylindrical shape with torn edges, gray in color, measuring 770 x 290 x 4 mm (object No. 11, illustration No. 4);
- metal object of deformed cylindrical shape with torn edges, gray in color, measuring 800 x 180x 4 mm (object No. 12, illustration No. 4);

[signature]

[signature]

- metal object of irregular shape with torn edges, gray in color, measuring 540 x 270 x 4 mm (object No. 13, illustration No. 5);
- metal object of irregular shape with torn edges, gray in color, measuring 620 x 370 x 4 mm (object No. 14, illustration No. 5);
- metal object of irregular shape with torn edges, gray in color, measuring 620 x 240 x 4 mm (object No. 15, illustration No. 5);
- metal object of deformed cylindrical shape (flattened cylinder) with torn edges, gray in color, measuring 680 x 240 x 4 mm (object No. 16, illustration No. 6);
- metal object of deformed cylindrical shape (flattened cylinder) with torn edges, gray in color, measuring 860 x 180 x 4 mm (object No. 17, illustration No. 6);
- metal object of deformed cylindrical shape (flattened cylinder) with torn edges, gray in color, measuring 990 x 240 x 4 mm (object No. 18, illustration No. 6);
- metal object of deformed cylindrical shape with torn edges, gray in color, measuring 730 x 620 x 4 mm (object No. 19, illustration No. 7);
- metal object of deformed cylindrical shape with torn edges, gray in color, measuring 850 x 630 x 4 mm (object No. 20, illustration No. 7);
- metal object of deformed cylindrical shape (flattened cylinder) with torn edges, gray in color, measuring 850 x 240 x 4 mm (object No. 21, illustration No. 7);
- metal object of deformed cylindrical shape (flattened cylinder) with torn edges, gray in color, measuring 750 x 400 x 4 mm (object No. 22, illustration No. 8);
- metal object of deformed cylindrical shape (flattened cylinder) with torn edges, gray in color, measuring 400 x 280 x 4 mm (object No. 23, illustration No. 8);
- metal object of deformed cylindrical shape (flattened cylinder) with torn edges, gray in color, measuring 720 x 210 x 4 mm (object No. 24, illustration No. 8);
- metal object of deformed cylindrical shape (flattened cylinder) with torn edges, gray in color, measuring 152 x 90 x 4 mm (object No. 25, illustration No. 9);
- metal object of irregular shape with torn edges, gray in color, measuring 930 x 260 x 4 mm (object No. 26, illustration No. 9);
- metal object of deformed cylindrical shape with torn edges, gray in color, measuring 650 x 350 x 4 mm (object No. 27, illustration No. 9);
- metal object of deformed cylindrical shape with torn edges, gray in color, measuring 850 x 600 x 4 mm (object No. 28, illustration No. 9);
- metal object of deformed cylindrical shape with torn edges, gray in color, measuring 250 x 180 x 4 mm (object No. 29, illustration No. 10);
- metal object of irregular shape with torn edges, gray in color, measuring 730 x 230 x 4 mm (object No. 30, illustration No. 10);

[signature]

[signature]

- metal object of irregular shape with torn edges, gray in color, measuring 380 x 190 x 4mm (object No. 31, illustration No. 10);
- metal object of deformed cylindrical shape with torn edges, gray in color, measuring 700 x 510 x 4mm (object No. 32, illustration No. 11);
- metal object of cylindrical shape with torn edges, gray in color, measuring 150 x 120 x 4mm (object No. 33, illustration No. 11);
- metal object of deformed cylindrical shape with torn edges, gray in color, measuring 850 x 340 x 4mm (object No. 34, illustration No. 11);
- metal object of deformed cylindrical shape with torn edges, gray in color, measuring 830 x 170 x 4mm (object No. 35, illustration No. 12);
- metal object of irregular shape with torn edges, gray in color, measuring 780 x 300 x 4mm (object No. 36, illustration No. 12);
- metal object of irregular shape with torn edges, gray in color, measuring 810 x 280 x 4mm (object No. 37, illustration No. 12);
- metal object of deformed cylindrical shape with torn edges, gray in color, measuring 990 x 520 x 4mm (object No. 38, illustration No. 13);
- metal object of deformed cylindrical shape (flattened cylinder) with torn edges, gray in color, measuring 650 x 370 x 4mm (object No. 39, illustration No. 13);
- metal object of deformed cylindrical shape with torn edges, gray in color, measuring 650 x 200 x 4mm (object No. 40, illustration No. 13);
- metal object of irregular shape with torn edges, dark gray in color, measuring 900 x 270 x 4mm (object No. 41, illustration No. 14);
- metal object of deformed cylindrical shape with torn edges, gray in color, measuring 830 x 180 x 4mm (object No. 42, illustration No. 14);
- metal object of irregular shape with torn edges, gray in color, measuring 740 x 320 x 4mm (object No. 43, illustration No. 14);
- metal object of irregular shape with torn edges, gray in color, measuring 860 x 350 x 4mm (object No. 44, illustration No. 15);
- metal object of irregular shape with torn edges, gray in color, measuring 700 x 200 x 4mm (object No. 45, illustration No. 15);
- metal object of deformed cylindrical shape with torn edges, gray in color, measuring 870 x 340 x 4mm (object No. 46, illustration No. 15);
- metal object of irregular shape with torn edges, gray in color, measuring 420 x 310 x 4mm (object No. 47, illustration No. 16);
- metal object of irregular shape with torn edges, gray in color, measuring 860 x 220 x 4mm (object No. 48, illustration No. 16);
- metal object of irregular shape with torn edges, gray in color, measuring 510 x 240 x 4mm (object No. 49, illustration No. 16);
- metal object of irregular shape with torn edges, gray in color, measuring 830 x 370 x 4mm (object No. 50, illustration No. 17);
- metal object of irregular shape with torn edges, gray in color, measuring 660 x 460 x 4mm (object No. 51, illustration No. 17);
- metal object of irregular shape with torn edges, gray in color, measuring 440 x 210 x 4mm (object No. 52, illustration No. 17);

[signature]

[signature]

- metal object of deformed cylindrical shape (flattened cylinder) with torn edges, gray in color, measuring 660 x 320 x 4 mm (object No. 53, illustration No. 18);
- metal object of irregular shape with torn edges, gray in color, measuring 640 x 390 x 4 mm (object No. 54, illustration No. 18);
- metal object of deformed cylindrical shape with torn edges, dark gray in color, measuring 560 x 440 x 4 mm (object No. 55, illustration No. 18);
- metal object of irregular shape with torn edges, gray in color, measuring 700 x 260 x 4 mm (object No. 56, illustration No. 19);
- metal object of deformed cylindrical shape (flattened cylinder) with torn edges, gray in color, measuring 920 x 220 x 4 mm (object No. 57, illustration No. 19);
- metal object of irregular shape with torn edges, gray in color, measuring 360 x 280 x 4 mm (object No. 58, illustration No. 19);
- metal object of irregular shape with torn edges, gray in color, measuring 690 x 530 x 4 mm (object No. 59, illustration No. 20);
- metal object of irregular shape with torn edges, gray in color, measuring 380 x 250 x 4 mm (object No. 60, illustration No. 20);
- metal object of irregular shape with torn edges, gray in color, measuring 410 x 270 x 4 mm (object No. 61, illustration No. 20);
- metal object of deformed cylindrical shape with torn edges, gray in color, measuring 250 x 180 x 4 mm (object No. 62, illustration No. 21);
- metal object of deformed cylindrical shape with torn edges, dark gray in color, measuring 250 x 170 x 4 mm (object No. 63, illustration No. 21);
- metal object of deformed cylindrical shape with torn edges, gray in color, measuring 240 x 160 x 4 mm (object No. 64, illustration No. 21);
- metal object of deformed cylindrical shape with torn edges, dark gray in color, measuring 250 x 160 x 4 mm (object No. 65, illustration No. 21);
- metal object, conical in shape, gray in color, measuring 135 x 130 x 4 mm (object No. 66, illustration No. 21);
- metal object of deformed cylindrical shape with torn edges, gray in color, measuring 270 x 130 x 4 mm (object No. 67, illustration No. 21);
- metal object, conical in shape, gray in color, measuring 140 x 130 x 4 mm (object No. 68, illustration No. 21);
- metal object, conical in shape, gray in color, measuring 140 x 150 x 4 mm (object No. 69, illustration No. 21);
- metal object of irregular shape with torn edges, gray in color, measuring 390 x 140 x 4 mm (object No. 70, illustration No. 22);
- metal object of irregular shape with torn edges, gray in color, measuring 300 x 280 x 4 mm (object No. 71, illustration No. 22);
- metal object of irregular shape with torn edges, gray in color, measuring 420 x 220 x 4 mm (object No. 72, illustration No. 22);

[signature]

[signature]

- 46 small metal fragments of irregular shape were also examined (object No. 73, illustration No. 23)

All of the metal objects (object Nos. 1–73) submitted for examination were made of magnetic metal and show signs of deformation.

The examination of object Nos. 1–72 revealed:

- longitudinal grooves in the form of threads (object Nos. 62, 63, 64, and 67);

- markings in the form of letters and numbers:

a) 1035 8 and SV GB N (object No. 2, illustration Nos. 24 and 25);

b) AV K4 ZhA ZN AN 4 (object No. 26, illustration No. 26);

c) 2U-86 (object No. 26, illustration No. 27), where 2U is probably the number of the lot or plant assembly;

86 is the year of manufacture;

d) CV Y N and 3 61 V OI (object No. 44, illustration Nos. 28 and 29);

e) 1886 and F 76 VI N (object No. 62, illustration Nos. 33 and 34);

f) 23-84 (object No. 44, illustration No. 30), where 23 is probably the number of the lot of plant assembly;

84 is the year of manufacture;

g) 2K-86 (object No. 50, illustration No. 31), where 2K is probably the number of the lot of plant assembly;

86 is the year of manufacture;

h) 1.-86 (object No. 24, illustration No. 32, where 1.-is probably the number of the lot of plant assembly;

86 is the year of manufacture;

Because the experts do not have access to the technical specifications for M-21 OF shells, it does not appear possible to determine the meanings of the markings preserved on the remnants of the shells (except for those denoted in sections c, f, g, and h).

Parts of markings were also found on a number of objects but could not be identified due to the significant deformation of the objects and thermal influence on them during firing and detonation.

Metal pins measuring ~4 mm in diameter and ~70 mm in length and wound with wire in the form of a spring 1.7 mm in diameter were attached to object Nos. 27, 29, 62, 63, 64 and 67. On one side is a plate (deformed) with apertures measuring ~15 mm in diameter, while on the other side can be seen traces of thermal influence in the form of chaotically spaced indentations of irregular shape with melted edges and black stratification (which appears to be soot) (illustration No. 35).

In order to answer the questions that were posed, submitted object Nos. 27, 29, 62, 63, 64 and 67 were compared with the corresponding parameters indicated in the standard technical documentation. The results of this examination are shown in the following table.

[signature]

[signature]

Table of comparison

Features of basic components	Subject of comparison	Examined objects
	Stabilizer unit	Objects similar to parts of stabilizer unit (object Nos. 27, 29, 62, 63, 64, 67)
Material of construction	gray metal	gray metal
Number of blades	4	4 apertures for blade attachment
Diameter, mm	122	~116-122
Number of nozzle holes	7	7
Hole for positioning screw	yes	yes

Based on a comparison of the objects with the drawings in the reference literature and the indicated dimensions, they are parts of stabilizer units for M-21OF rocket-propelled shells (illustration Nos. 35, 36, 37, 38, 40 and 41).

CONCLUSIONS

1. The 72 large and 46 small metal fragments recovered during the inspection of the territory, residential and non-residential buildings of the Skhidnyi microdistrict, Ordzhonikidze District, City of Mariupol, after the shelling on 1/24/2015, which were submitted for examination, are components of munitions, specifically remnants of M-21 OF high-explosive fragmentation shells.

2. The following markings were found on the objects recovered during the inspection of the incident site and submitted for examination:

- on object No. 26 (2U-86), where 2U is probably the number of the lot or plant assembly and 86 is the year of manufacture;
- on object No. 44 (23-84), where 23 is probably the number of the lot of plant assembly and 84 is the year of manufacture;
- on object No. 50 (2K-86), where 2K is probably the number of the lot of plant assembly and 86 is the year of manufacture;
- on object No. 24 (1.-86) where 1.- is probably the number of the lot of plant assembly and 86 is the year of manufacture.

It does not appear possible to answer the question as to the meaning of the other markings preserved on the shell fragments for the reasons indicated in the examination section.

3. Based on the inspection of the incident site and recovered objects, it is possible to identify the specific type and sort of munitions as a 122-mm M-21 OF unguided rocket-propelled high-explosive fragmentation shell (item 9M22U). These shells were fired from BM 21 Grad multiple rocket launchers.

4. Based on the characteristics of the recovered objects, the cause of the explosion(s) was the detonation of a shell (or detonations of shells) fired from BM 21 Grad multiple rocket launchers.

5. Object Nos. 27, 29, 62, 63, 64, and 67 are parts of the standard bodies of stabilizer units for M-21 OF unguided rocket-propelled high-explosive fragmentation shells (item 9M22U), which are designed to stabilize the flight of a shell.

Object Nos. 1–26, 28, 30–61, 65, 66, 68–72 and 73 are parts of the bodies of M-21 OF 122 mm unguided rocket-propelled high-explosive fragmentation shells (item 9M22U).

[signature]

[signature]

It does not appear possible to provide an answer as to the purpose of each fragment submitted for examination due to the significant deformation of said objects.

Notes:

1. The 72 large metal fragments recovered during the inspection of the territory, residential and non-residential buildings of the Skhidnyi microdistrict, Ordzhonikidze District, City of Mariupol, after the shelling on 1/24/2015, were numbered with black marker, described in the examination section of the opinion, and recorded in the photo table. Due to the large number, significant size and weight, and sharp, torn edges of the metal fragments, they were returned in unpacked form to the investigations department of the Donetsk Regional Directorate of the Security Service of Ukraine.

2. The 46 small metal fragments recovered during the inspection of the territory, residential and non-residential buildings of the Skhidnyi microdistrict, Ordzhonikidze District, City of Mariupol, after the shelling on 1/24/2015, were packed into a bag, which was sealed with a piece of paper bearing the impression of the seal "Security Service of Ukraine. For physical evidence, examination items and samples No. 1," and the signatures of the experts.

Enclosed: table of illustrations (10 pages)

Experts

[signature]

S. Zholak

[signature]

I. Borozenets

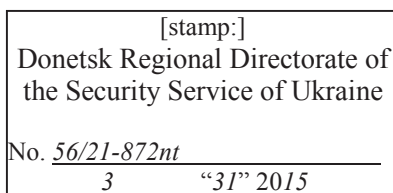

**SECURITY SERVICE OF UKRAINE
TABLE OF ILLUSTRATIONS
TO EXPERT OPINION No. 142 of 3/30/2015**

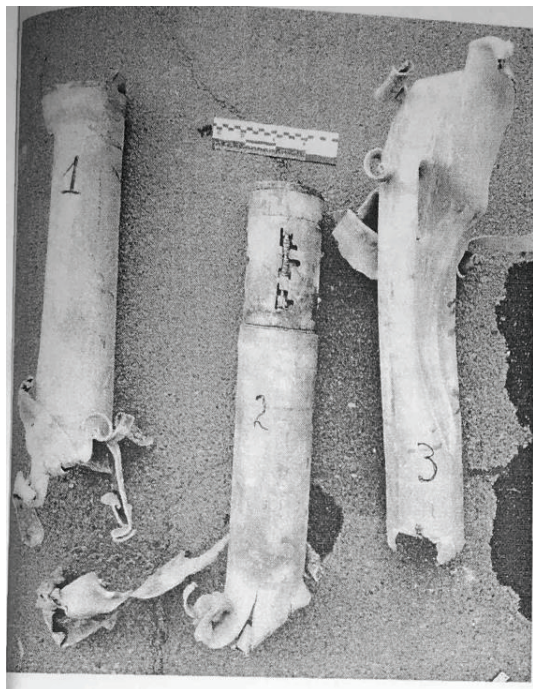

Illustration No. 1. Examination item Nos. 1–3

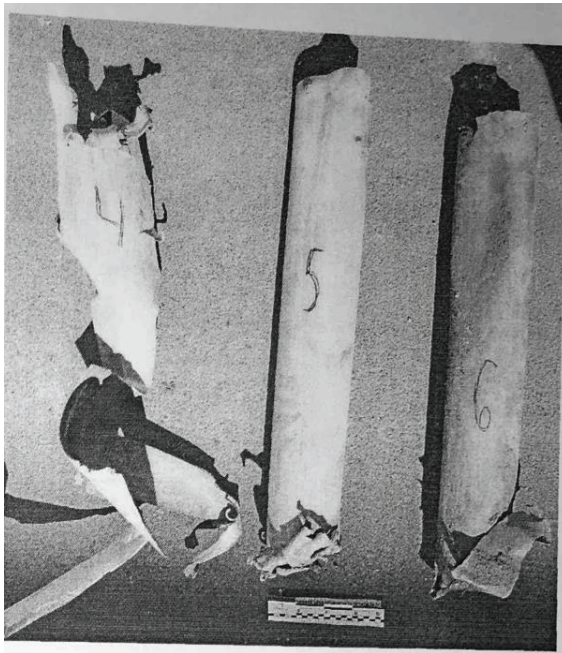

Illustration No. 2. Examination item Nos. 4–6



Illustration No. 3. Examination item Nos. 7–9

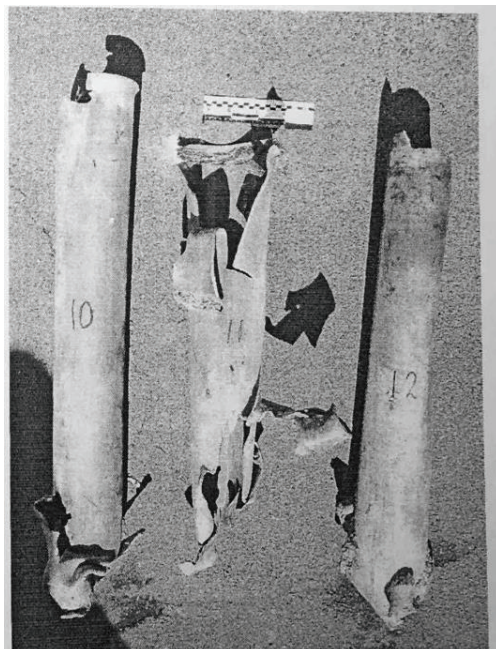

Illustration No. 4. Examination item Nos. 10–12

Experts

[signature] S. Zholak
 [signature] I. Borozenets

SECURITY SERVICE OF UKRAINE
TABLE OF ILLUSTRATIONS
TO EXPERT OPINION No. 142 of 3/30/2015



Illustration No. 5. Examination item Nos. 13–15



Illustration No. 6. Examination item Nos. 16–18



Illustration No. 7. Examination item Nos. 19–21

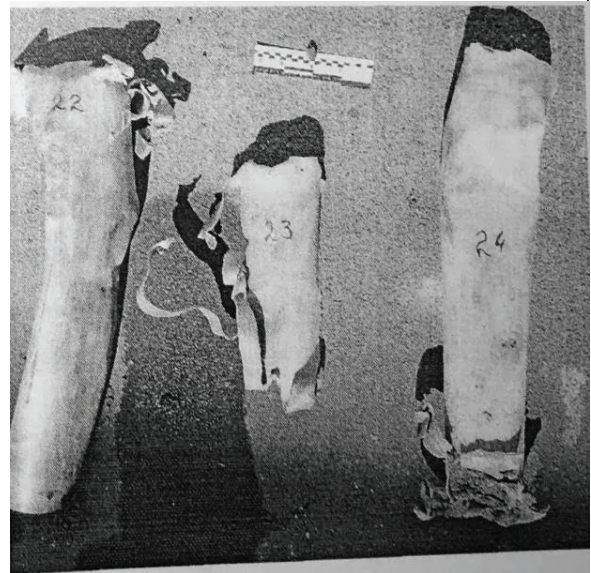

Illustration No. 8. Examination item Nos. 22–24

Experts

[signature] S. Zholak
[signature] I. Boroznets

**SECURITY SERVICE OF UKRAINE
TABLE OF ILLUSTRATIONS
TO EXPERT OPINION No. 142 of 3/30/2015**



Illustration No. 9. Examination item Nos. 25–28



Illustration No. 10. Examination item Nos. 29–31



Illustration No. 11. Examination item Nos. 32–34



Illustration No. 12. Examination item Nos. 35–37

Experts

[signature] S. Zholak
[signature] I. Borozenets

**SECURITY SERVICE OF UKRAINE
TABLE OF ILLUSTRATIONS
TO EXPERT OPINION No. 142 of 3/30/2015**



Illustration No. 13. Examination item Nos. 38–40

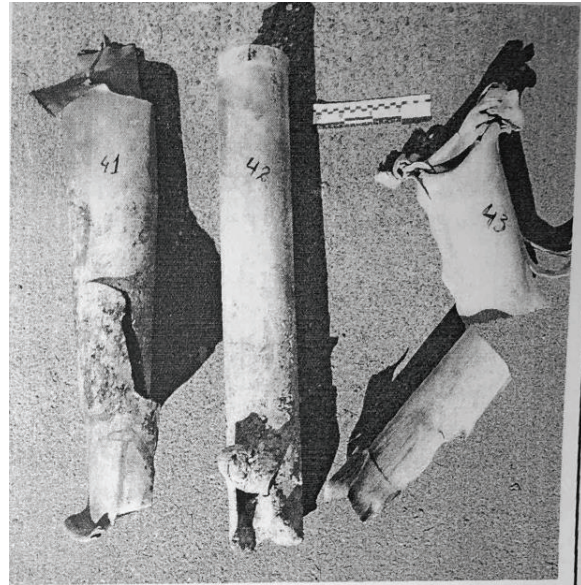

Illustration No. 14. Examination item Nos. 41–43

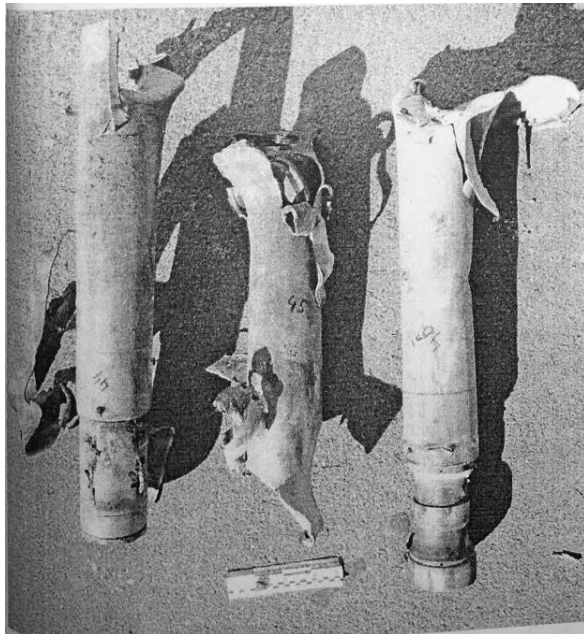

Illustration No. 15. Examination item Nos. 44–46

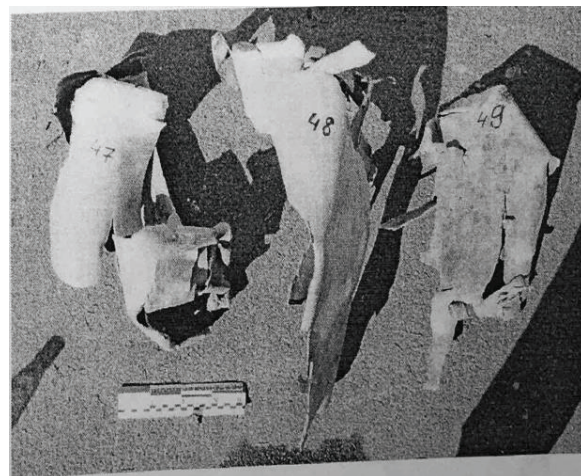

Illustration No. 16. Examination item Nos. 47–49

Experts

[signature] S. Zholak
[signature] I. Borozenets

**SECURITY SERVICE OF UKRAINE
TABLE OF ILLUSTRATIONS
TO EXPERT OPINION No. 142 of 3/30/2015**



Illustration No. 17. Examination item Nos. 50–52

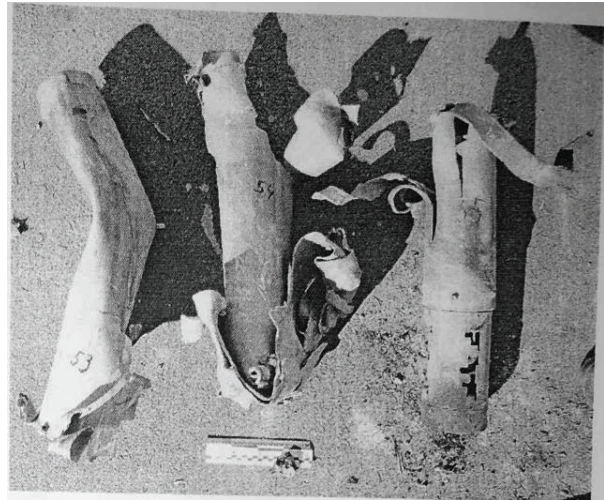

Illustration No. 18. Examination item Nos. 53–55



Illustration No. 19. Examination item Nos. 56–58



Illustration No. 20. Examination item Nos. 59–61

Experts

[signature] S. Zholak
[signature] I. Borozenets

**SECURITY SERVICE OF UKRAINE
TABLE OF ILLUSTRATIONS
TO EXPERT OPINION No. 142 of 3/30/2015**

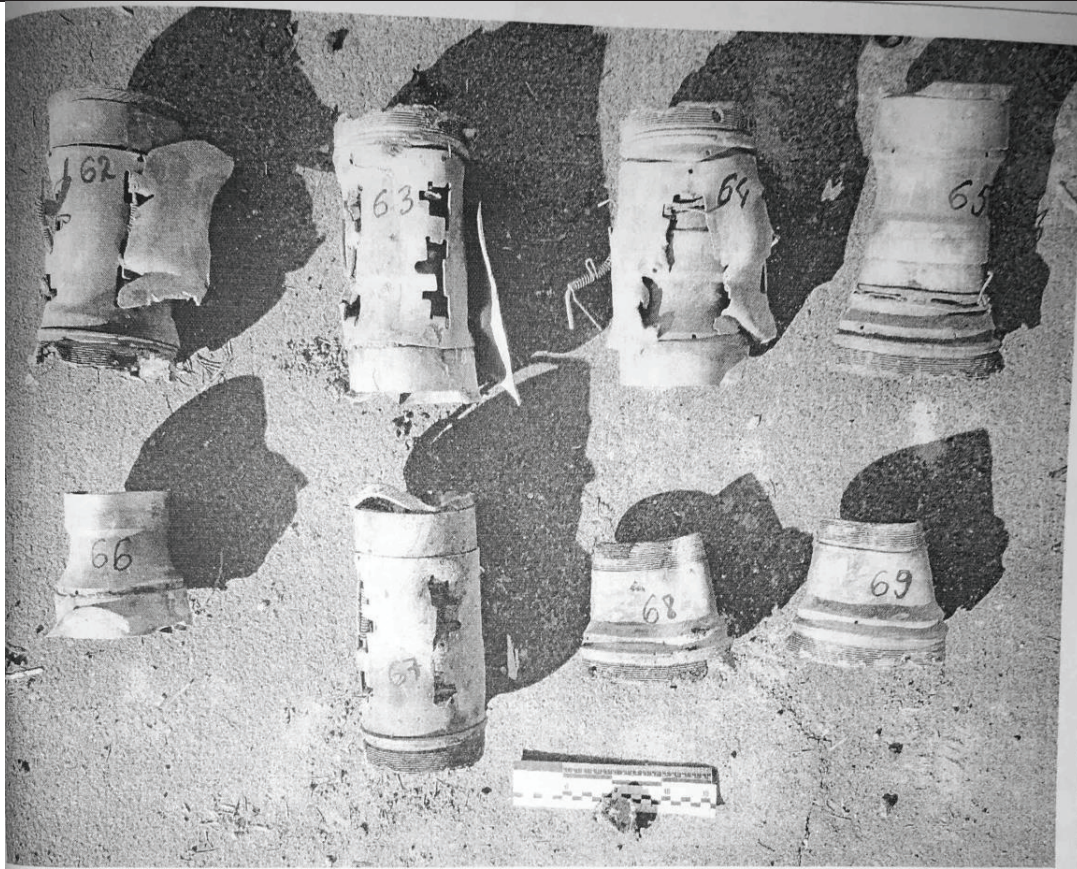

Illustration No. 21. Examination item Nos. 62–69



Illustration No. 22. Examination item Nos. 70–72



Illustration No. 23. Examination items (46 fragments)

Experts

[signature] S. Zholak
[signature] I. Borozenets

SECURITY SERVICE OF UKRAINE
TABLE OF ILLUSTRATIONS
TO EXPERT OPINION No. 142 of 3/30/2015



Illustration No. 24. Markings on examination item No. 2



Illustration No. 25. Markings on examination item No. 2

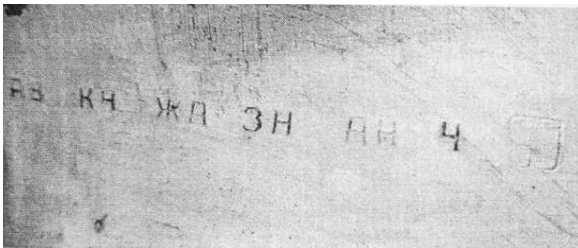

Illustration No. 26. Markings on examination item No. 26.



Illustration No. 27. Markings on examination item No. 26.

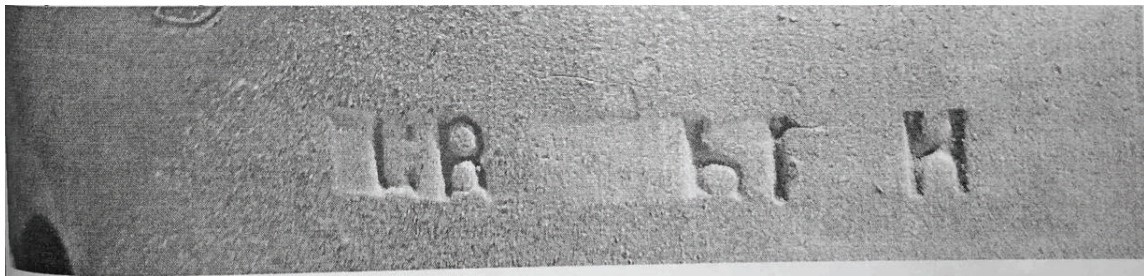

Illustration No. 28. Markings on examination item No. 44.

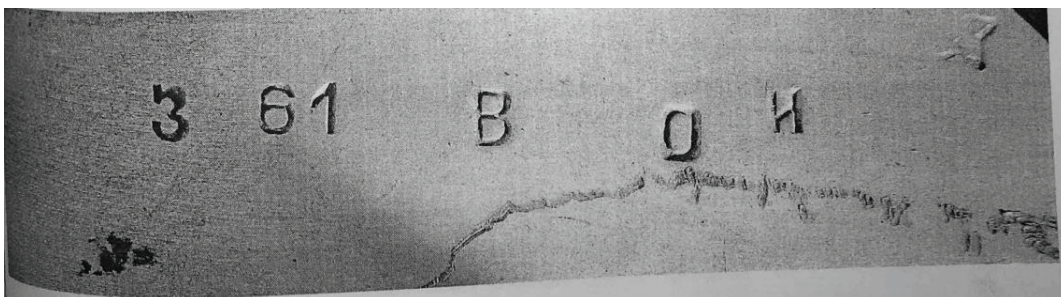

Illustration No. 29. Markings on examination item No. 44.

Experts

[signature]

S. Zholak

[signature]

I. Borozenets

SECURITY SERVICE OF UKRAINE
TABLE OF ILLUSTRATIONS
TO EXPERT OPINION No. *142* of 3/30/2015

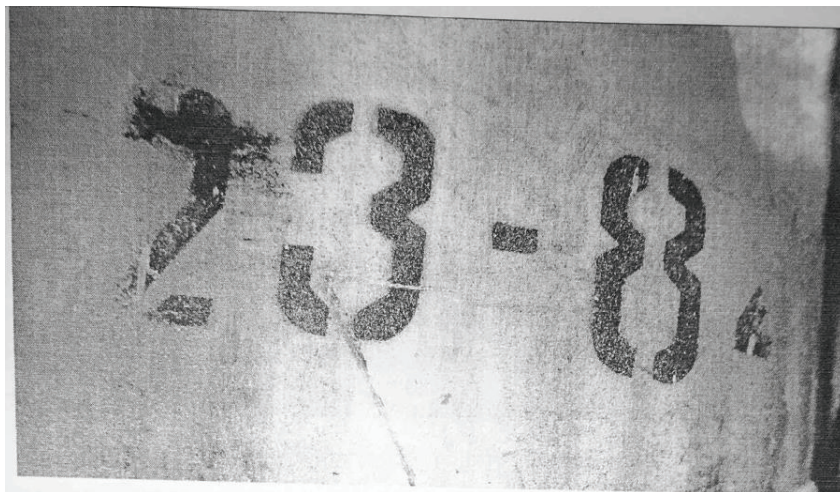

Illustration No. 30. Markings on examination item No. 44.

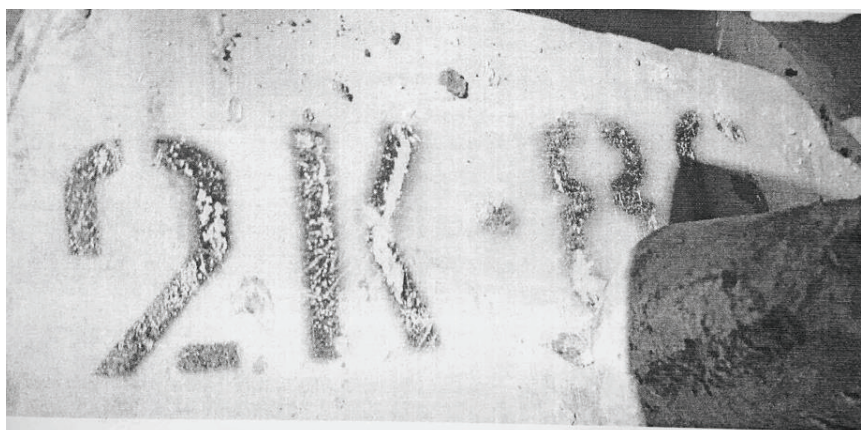

Illustration No. 31. Markings on examination item No. 50.

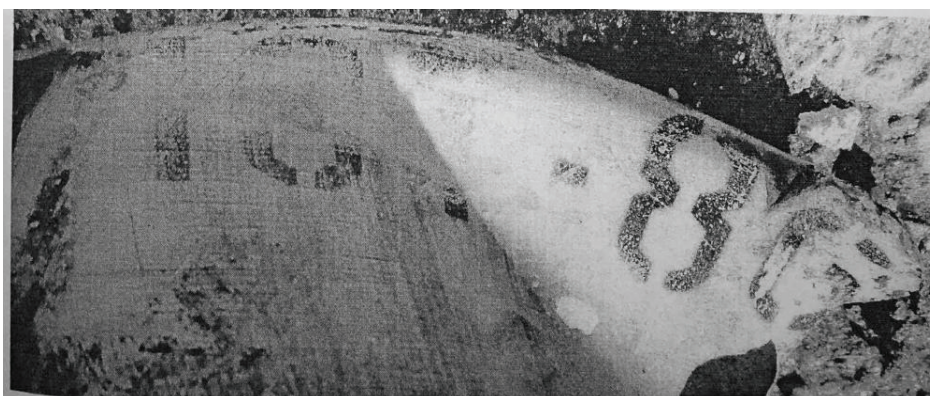

Illustration No. 32. Markings on examination item No. 24.

Experts

[signature]

S. Zholak

[signature]

I. Borozenets

SECURITY SERVICE OF UKRAINE
TABLE OF ILLUSTRATIONS
TO EXPERT OPINION No. 142 of 3/30/2015



Illustration No. 33 Markings on examination item No. 62.

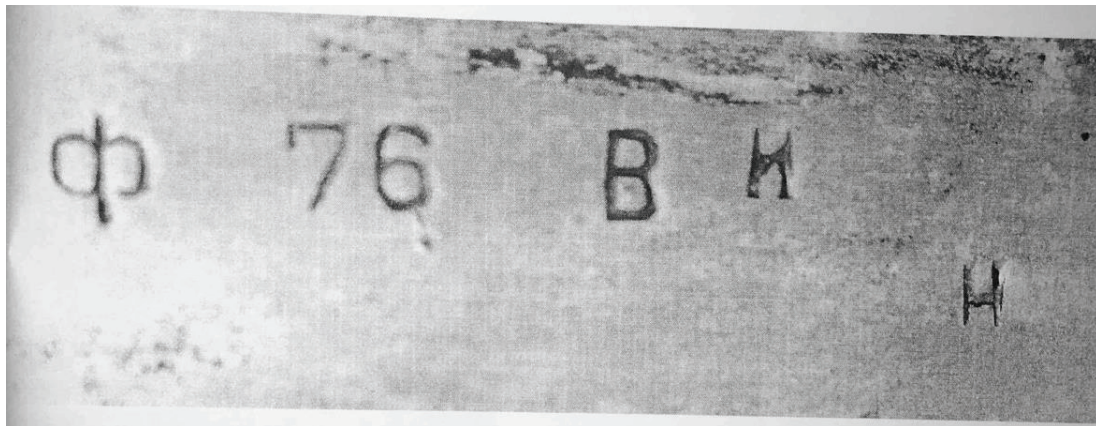

Illustration No. 34. Markings on examination item No. 62.

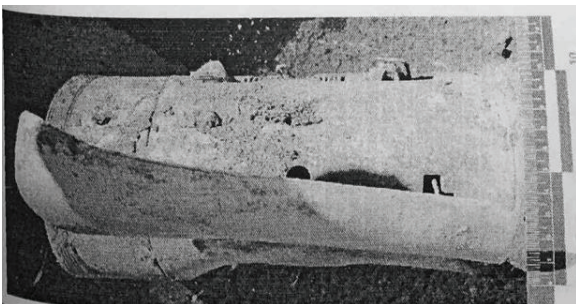
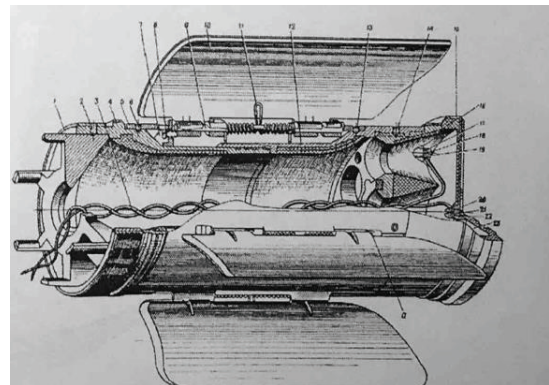

Illustration No. 35. Object No. 27



[illegible]

Illustration No. 36. Stabilizer unit of M-21OF shell

Experts

[signature]

S. Zholak

[signature]

I. Borozenets

SECURITY SERVICE OF UKRAINE
TABLE OF ILLUSTRATIONS
TO EXPERT OPINION No. 142 of 3/30/2015

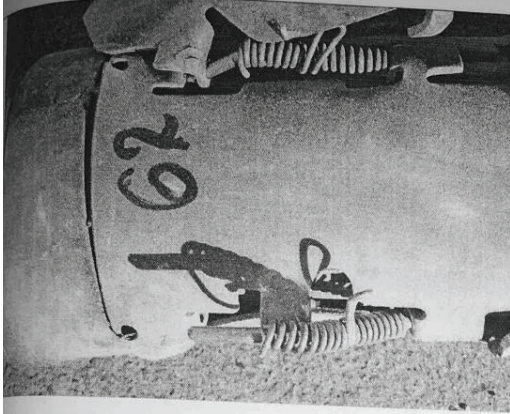

Illustration No. 37. Object No. 62

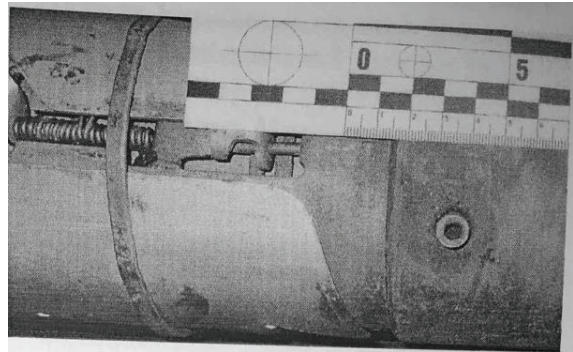
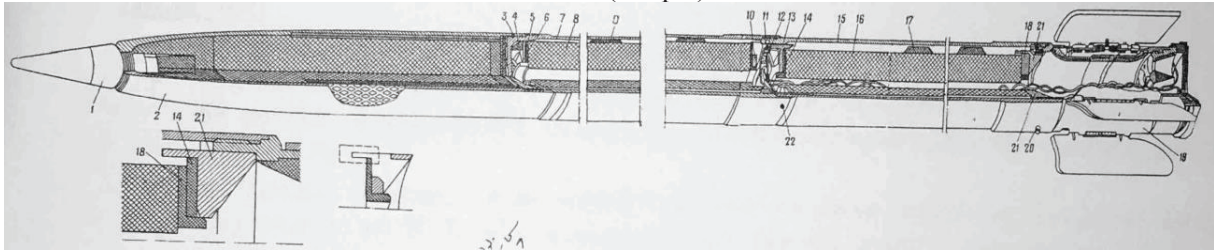

Illustration No. 38. Stabilizer unit of M-21OF shell (sample)



[illegible]

Illustration No. 39. Schematic drawing of M-21OF shell

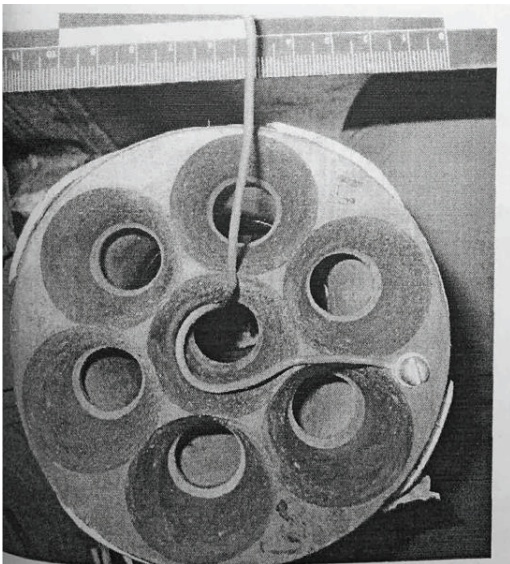

Illustration No. 40. Cap/nozzle hole of stabilizer block for M-21OF shell (sample)

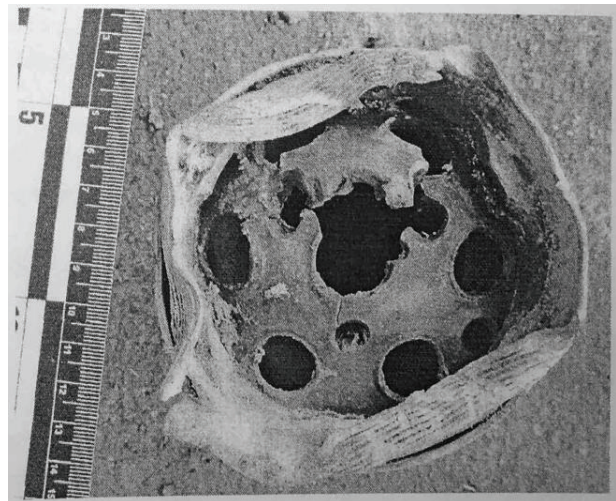

Illustration No. 41. Object No. 33

Experts

[signature]

S. Zholak

[signature]

I. Borozenets

Annex 116

Expert Conclusion No. 532/2014, drafted by the Forensic Research Center, Ministry of Internal Affairs of Ukraine, Main Directorate of the Ministry of Internal Affairs of Ukraine in Kharkiv Region (3 April 2015)

This document has been translated from its original language into English, an official language of the Court, pursuant to Rules of the Court, Article 51.

Pursuant to Rules of the Court Article 51(3), Ukraine has translated only an extract of the original document constituting this Annex. In further compliance with this Rule, Ukraine has provided two certified copies of the full original-language document

MINISTRY OF INTERNAL AFFAIRS OF UKRAINE
MAIN DIRECTORATE OF THE MINISTRY OF INTERNAL AFFAIRS OF UKRAINE
IN KHARKIV REGION

FORENSIC RESEARCH CENTER

34 vul.Kovtuna, Kharkiv

Tel. (057)721-23-39

vvtptd_kharkov@ukr.net

EXPERT CONCLUSION

04.03.2015

Kharkiv

No. 532/2014

The forensic fire and explosives analysis department of the Forensic Research Center (FEAD FRC) at the Kharkiv Region Main Directorate of the Ministry of Internal Affairs of Ukraine received, on 11.11.2014, a resolution dated 11.10.2014 and issued by the senior forensic investigator, Senior Lieutenant of Justice I.M. Babak of the investigations department at the Kharkiv Regional directorate of the Security Service of Ukraine, as part of criminal proceedings No. 2201422000000305, accompanied by letter No. 70/6-3867nt of 11.10.2014 from the Kharkiv Regional Directorate of the Security Service of Ukraine, requesting a comprehensive forensic explosives analysis and analysis of explosive substances and products of explosion and gunfire according to expert specialism 5.1 (investigation of explosive substances and products of explosion and gunfire) and expert specialism 5.2 (investigation of explosive devices and the traces and circumstances of an explosion).

The task of forensic analysis has been assigned to the head of the fire forensics sector at FEAD FRC, Police Lieutenant-Colonel Dmytro Arkadiyovych Karakurkchi, who has a higher education degree in military engineering and is a qualified forensic expert certified to conduct forensic analysis according to expert specialism No. 5.1 (investigation of explosive devices and products of explosion and gunfire, certificate No. 11537 issued by the Expert Qualifications Commission of the Ministry of Internal Affairs of Ukraine on 11.29.2012) and a qualified forensic expert certified to conduct forensic explosives analysis according to expert specialism No. 5.2 (investigation of explosive devices and the traces and circumstances of an explosion, certificate No. 13089 issued by the Expert Qualifications Commission of the Ministry of Internal Affairs of Ukraine on 10.03.2014), employed as an expert since 2011.

I understand that a deliberately false conclusion or unjustified refusal to perform assigned duties is an offence under Articles 384 and 385 of the Penal Code of Ukraine.

[seal:] Forensic Research Center No. 12 Kharkiv Region Main
Directorate Ministry of Internal Affairs of Ukraine

[signature] **D.A. Karakurkchi**

[seal:] Forensic Research Center No. 12 Kharkiv Region
Main Directorate Ministry of Internal Affairs of Ukraine
Forensic expert [signature]

D.A. Karakurkchi

Background on the case (*known from the investigator's resolution to request a forensic analysis*):
“On 11.09.2014, around 9:38 p.m., the duty post received an alarm signal as a result of an explosion at the Stena café located at 13 vul. Rymarska, Kharkiv.”

The following was submitted for forensic analysis:

- Copy of the incident scene inspection report of 11.09.2014 compiled by Police Lieutenant M.V. Manzhulin, an investigator of the Dzerzhinsky district investigations department, Kharkiv city directorate of the Ministry of Internal Affairs Main Directorate in Kharkiv Region, 2 pages;
- Table illustrating the incident scene inspection report of 11.09.2014, 7 pages;
- Copy of the incident scene inspection report of 11.10.2014 compiled by Police Lieutenant (name illegible), an investigator of the Dzerzhinsky district investigations department, Kharkiv city directorate of the Ministry of Internal Affairs Main Directorate in Kharkiv Region, 3 pages;
- Copy of the incident scene inspection report of 11.10.2014 compiled by Police Lieutenant I.I. Shapovalov, an investigator of the Dzerzhinsky district investigations department, Kharkiv city directorate of the Ministry of Internal Affairs Main Directorate in Kharkiv Region, 2 pages;
- Copy of the incident scene inspection report of 11.10.2014 compiled by Police Senior Lieutenant S.Ye. Toporkov, an investigator of the Dzerzhinsky district investigations department, Kharkiv city directorate of the Ministry of Internal Affairs Main Directorate in Kharkiv Region, 2 pages;
- Copy of the incident scene inspection report of 11.10.2014 compiled by Police Captain M.M. Lukyanenko, an investigator of the Dzerzhinsky district investigations department, Kharkiv city directorate of the Ministry of Internal Affairs Main Directorate in Kharkiv Region, 2 pages;
- Copy of the incident scene inspection report of 11.10.2014 compiled by Police Lieutenant M.V. Manzhulin, an investigator of the Dzerzhinsky district investigations department, Kharkiv city directorate of the Ministry of Internal Affairs Main Directorate in Kharkiv Region, 3 pages;
- Objects retrieved during the incident scene inspection, in 25 packages.

The following questions were put to forensic analysis:

1. Do the objects found at the scene of the incident and submitted for investigation bear traces of explosive substances? If yes, which ones?
2. Was the explosion at the Stena café (13 vul. Rymarska, Kharkiv) around 9:38 p.m. on 11.09.2014 caused by an explosive device? If yes, what type of device is it? What make is this device: an IED or industrial?
3. What method of detonation was used in this instance?
4. If the explosion was caused by ammunition, what type is it (grenades, mines, shells etc.)?
5. Do the materials submitted for analysis contain any data pointing to the identifying characteristics of the person who made the explosive device (professional skills, knowledge of the manufacturing process and operation of explosive devices, etc)?

List of forensic analysis methods entered in the Register of Forensic Analysis Methods at the Ministry of Justice of Ukraine and used in this analysis:

1. Comprehensive investigation of explosive devices, explosive substances and traces of explosion (registration code 0.1.12)
2. General methodology of assigning and performing comprehensive forensic analyses conducted by a board of experts (registration code 0.1.16)
3. Explosive substance investigation (registration code 5.1.15)
4. Investigation of explosive substances and explosion products using chemical methods and thin-layer chromatography (registration code 5.1.23)

Environmental conditions were recorded in the department's environmental conditions journal QF.6-5.3-01.00.1 according to procedure QP.6-5.3-01 (conforming to the norms of GOST 12.1.005-88).

In the resolution requesting a comprehensive forensic explosives analysis and analysis of explosive substances and products of explosion and gunfire, the senior forensic investigator, Senior Lieutenant of Justice I.M. Babak of the investigations department at the Kharkiv Regional directorate of the Security Service of Ukraine gave permission to use destructive methods of investigation and to fully or partially destroy investigated objects.

INVESTIGATION [1-12]

The study and analysis of documents and illustrative material submitted for investigation [1, 2, 5-7, 10, 11]

The following documents were submitted for investigation:

- Copy of the incident scene inspection report of 11.09.2014 compiled by Police Lieutenant M.V. Manzhulin, an investigator of the Dzerzhinsky district investigations department, Kharkiv city directorate of the Ministry of Internal Affairs Main Directorate in Kharkiv Region, 2 pages;
- Table illustrating the incident scene inspection report of 11.09.2014, 7 pages;
- Copy of the incident scene inspection report of 11.10.2014 compiled by Police Lieutenant (name illegible), an investigator of the Dzerzhinsky district investigations department, Kharkiv city directorate of the Ministry of Internal Affairs Main Directorate in Kharkiv Region, 3 pages;
- Copy of the incident scene inspection report of 11.10.2014 compiled by Police Lieutenant I.I. Shapovalov, an investigator of the Dzerzhinsky district investigations department, Kharkiv city directorate of the Ministry of Internal Affairs Main Directorate in Kharkiv Region, 2 pages;
- Copy of the incident scene inspection report of 11.10.2014 compiled by Police Senior Lieutenant S.Ye. Toporkov, an investigator of the Dzerzhinsky district investigations department, Kharkiv city directorate of the Ministry of Internal Affairs Main Directorate in Kharkiv Region, 2 pages;
- Copy of the incident scene inspection report of 11.10.2014 compiled by Police Captain M.M. Lukyanenko, an investigator of the Dzerzhinsky district investigations department, Kharkiv city directorate of the Ministry of Internal Affairs Main Directorate in Kharkiv Region, 2 pages;

- Copy of the incident scene inspection report of 11.10.2014 compiled by Police Lieutenant M.V. Manzhulin, an investigator of the Dzerzhinsky district investigations department, Kharkiv city directorate of the Ministry of Internal Affairs Main Directorate in Kharkiv Region, 3 pages;

The following was established from the copy of an incident scene inspection report dated 11.09.2014 by Police Lieutenant M.V. Manzhulin, an investigator of the Dzerzhinsky district investigations department, Kharkiv city directorate of the Ministry of Internal Affairs Main Directorate in Kharkiv Region: *“The object of inspection is the building of the Stena pub located at 13 vul. Rymarska, Kharkiv. The area opposite the above pub is covered with shards of glass and plastic and metal fragments. Across the road, opposite the above pub is a building with the sign “Proconsul.” This paved area is cordoned off with tape. The asphalted road and pavements from the perimeter of building No. 13 along Rymarska Street to the building opposite are covered with broken glass. To the right of the entrance to the building with the sign “Proconsul,” on the roadside facing down, is a grey VAZ car showing broken glass; no mechanical damage to the car is found. On the asphalt next to the right side of the car are brown fragments (word illegible) VAZ 21-10 reg. No. AX7669CM. In front of and under the car there are 2 metal structures in the shape of a pipe, a large amount of glass and parts of a wooden floor. The right window is smashed and caved in. Next to the right back door handle there is a dent 10 cm in length and extensive damage to bodywork. Further along the road between the car and the pavement there are multiple shards of broken glass, parts of plastic structures and parts of metal structures. Next to building 13 in Rymarska Street is a Volkswagen Sharan car reg. region 01 900-09 KO. There is some damage to the bodywork on the right side of the car in the form of chipping, and the right side view mirror is snapped off. The mirror case has (illegible word) two, about 7 cm long and 3 cm wide. There is some broken glass on the car roof. Behind the car there is a metal fence separating the pavement and road. There are shards of glass on the metal fence, as well as rubber seals from PVC windows. On the pavement there are multiple shards of glass, bits of foam rubber, a soft toy and plastic parts of a PVC window. Opposite the corner of the building with the number 13 in Rymarska Street, behind the metal fence near the border on the right side of the asphalted road, there is a black metal plate which says Stena Bar. There are four windows at ground level. Window No. 1, measuring 120 x 120 cm, has no glazing and has a part of a PVC window at the bottom. Window No. 2, measuring 1.30 x 120 cm, has no glazing. No. 3, 90 x 100 cm, no glazing. No. 4, 90 x 110 cm, no glazing. There is a grey VAZ 2110 car on the pavement. There are multiple shards of glass. On the pavement in front of the house there are large shards of glass covered with mirror film. Between windows 2 and 3 there are shards of glass from the café’s advert. The window*

immediately next to the archway has a hole measuring 90 x 100 cm. There is a large piece of broken glass on the melted surface. A huge piece of glass measuring 100 x 70 cm. On the road next to the pavement there is a metal structure [illegible] in the form of a pipe and parts of a metal window. Next to the archway gate (word illegible) and by the entrance to the Proconsul office building, there are multiple shards of glass and window parts lying on the asphalt. To the left of the corner of building 13 in Rymarska Street is a courtyard entrance. On the pavement next to the entrance are brown stains that look like blood. On the left column next to the entrance, at about 150 cm above ground there are light brown stains that look like blood. On column No. 2, there are stains that look like blood. This concludes the inspection of the incident scene.”

The following was established from the copy of an incident scene inspection report dated 11.10.2014 by Police Lieutenant A.V. Buymytsky, an investigator of the Dzerzhinsky district investigations department, Kharkiv city directorate of the Ministry of Internal Affairs Main Directorate in Kharkiv Region: *“The scene of the incident is the Stena pub building located at 13 vul. Rymarska, Kharkiv. The scene of the incident is in the basement of a three-story building at the above address. The entrance to the building is on the left. The entrance is from the side of the building. Above the entrance there is a detachable plate with the sign “Stena.” The door is painted grey. On inspection, the door is found to be deformed in a wave-like pattern. The door’s external surface has a protrusion as a result of deformation. In the middle and bottom of the outer door surface, on the right edge of the door bar there is damage in the form of metal impression. Further inspection of the door has established that the top and bottom grey metal hinges are snapped off. At the fixing point (words illegible) ...The following damage was registered inside the building upon entering (words illegible) ...on the ceiling, at about 2 m high there is damage to thermal insulation. To the right of the building entrance (the rest of the sentence is illegible). There is a thick deposit of a grey substance that looks like soot on the outer surface of the bar, on the metal structures built into the bar and on the lateral surface of the room’s columns facing the bar. There are multiple track-style indentations on the surface of the bar in the direction away from the hole to the left side of the bar. The tracks have a radial trajectory from the hole to the bar. When removing fragments of the interior from the blast hole it was established that the surface under the floor is sand, and there is a distinct smell of ammonia in the vicinity of the hole. The interior behind the bar is destroyed. To the right of the bar is a 1.7 m tall refrigerator with the door missing.*

Inside the refrigerator there are many brown glass bottles with traces of soot and dust. On the left behind the refrigerator there is a doorway to the adjacent room which is entered via stairs. The door to the room was missing at the time of inspection, located 4 m away from the back entrance to the building. An inspection of the ceiling above the bar established that the insulating material, glass wool, bore traces of a grey substance.”

The following was established from the copy of an incident scene inspection report dated 11.10.2014 by Police Captain M.M. Lukyanenko, an investigator of the Dzerzhinsky district investigations department, Kharkiv city directorate of the Ministry of Internal Affairs Main Directorate in Kharkiv Region: *“during the additional inspection conducted in order to find components of a possible explosive device, the premises of the café at 13 vul. Rymarska, Kharkiv were divided into four imaginary zones, after which the debris, fragments and items of the interior were moved onto a platform located opposite the entrance and placed separately onto a surface covered with film and cotton sheets. After this, the removed items were thoroughly sorted, sifted and inspected, during which the following objects were found and retrieved: from the crater and the adjacent area (1.5 m radius): 1) fragments of fabric showing traces of charring and soot, with torn edges; 2) a 95 x 95 mm square metal object with traces of soot; 3) magnet fragments showing traces of soot; 4) metal fragments showing signs of deformation in the form of protrusions and ruptures; 5) pieces of a green fabric with a zipped pocket (unzipping the pocket reveals a piece of paper inside with a drawing in ballpoint and color pens and with letters and numbers written in ballpoint on the reverse). The following was retrieved from the stairs in the middle of the café: 6) Multiple metal fragments with elements of grooving which have soot on the surface.”*

The following was established from the copy of an incident scene inspection report dated 11.10.2014 by Police Lieutenant M.V. Manzhulin, an investigator of the Dzerzhinsky district investigations department, Kharkiv city directorate of the Ministry of Internal Affairs Main Directorate in Kharkiv Region: *“The object of the additional inspection is the building of the Stena bar located at 13 vul. Rymarska, Kharkiv. Entrance to the building is through the doorway in which the doors are open at the time of inspection. There is deformation to the door. There are bits of cardboard on the floor by the entrance. On entry through the doorway one can see Room No. 1. Entrance to the room is through (word illegible) down the stairs on which there are items made of green fabric. To the right of the stairs there are tables and chairs lying around in disarray. To the right of the entrance door there is a badly deformed wall. Hanging on the wall under the ceiling is a television set, which is badly deformed and damaged. It is not possible to see the TV set’s make. To the right of the TV set, next to window No. 1 there is a white air conditioner showing serious damage.*

Window No. 1, measuring approximately 120 x 120 cm has no glazing. At the bottom of the window, there is a part from its white metal frame. Window No. 2, measuring 120x 130 cm, has no glazing. Opposite window No. 2 there is a heater showing signs of deformation. Window No. 3, measuring approximately 90 x 100 cm has no glazing. Opposite the window there is a black audio speaker and a maroon drum. Opposite the window, there are bits of wood and broken glass. On the wall between windows, three and 4 there is a black Yamaha audio speaker. Window No. 4 measuring 90 x 100 cm has no glazing. On the windowsill opposite the window there is a black electric device showing signs of mechanical damage. The wall with the window facing Rymarska Street is badly deformed. The wall to the left of the window is badly deformed. Opposite the wall, there is a music stand which has sustained mechanical damage. About 5 meters away from the window there is a doorway with no door. The room's walls show signs of serious deformation. On the floor, there are bits of concrete, wood and plastic. About 2 meters away from the doorway is another doorway with a metal and plastic doorframe, but the internal door is missing. On the floor through the doorway, there are bits of plastic, while the ceiling and walls behind the doorway are deformed. Through the corridor, one can see the passage to the restroom, which is covered by a green plastic tile. To the left of the doorway is another doorway with the door missing. There are bits of wood and plastic on the floor of this passage. There are signs of deformation to the walls and ceiling. To the left of the doorway is a bar on which one can see bits of wood and plastic, glasses and fragments, as well as a black electric device. The bar is badly deformed. Behind the bar, there are bits of wood, plastic and wood frame, with broken glass on top. Opposite the bar at the rear of the building, there is a doorway with the door missing. On the floor behind the doorway, there are items and bits of wood and plastic. Straight on from this doorway is another doorway behind which there are tiled stairs going up. In the room, across from the middle of the bar, there is a crater about 30 cm deep and 50 cm in diameter. The crater is 20 cm long at its deepest and is covered with rocks, and one can see bits of rebar. On the floor around the crater, about 20-30 cm away from the edge, there are black footprints. The soil inside the crater is brown and, in parts, black. Next to the musical instruments, there is a brown lady's handbag with mechanical damage. Next to the handbag, there is a Ukrainian citizen's passport in the name of Olga Yuryevna Vitushnyak, DOB 08.20.1992. In the epicenter of the blast, inside the bar, there is a Zip bag containing bandage with fluid residue. This concludes the inspection of the incident scene."

Therefore, based on the circumstances and specifics of the incident scene described in the incident scene inspection reports, it is possible to conclude that the premises of the Stena bar at 13 vul. Rymarska, Kharkiv shows damage typical of the brisance, incendiary, thermal and fragmentation effects of explosive action. The center of the blast is the floor surface next to the bar.

The absence of items in the said building capable of causing a physical explosion (canisters with compressed gas or air, paint cans, steam boilers, etc) as well as the size of the crater, the nature of damage and the appearance of soot make it possible to conclude that an explosive device has been detonated, carrying an explosive charge with a negative oxygen balance and with the power of about 1-1.2 kg in the trotyl (TNT) equivalent.

Inspection and opening of sealed bags, preliminary appearance of investigated objects [1-3, 5-11]

The objects were delivered for investigation sealed in 25 packages: packages No. 1-25.

Packages No. 1-7 and 10-17 are the standard polymeric bags of the Ministry of Internal Affairs of Ukraine Expert Service duly sealed along the adhesive line (Figures 1-25 of the illustrative table appended to the expert conclusion). On the front of each bag, there is writing and signatures in longhand using blue ink:

- **package 1** (Ministry of Internal Affairs of Ukraine Expert Service bag No. 1784474):

Ministry of Internal Affairs of Ukraine Directorate in Kharkiv Region city, district Dzerzhinsky district Description: Inspection of the incident scene at 13 vul. Rymarska, Kharkiv, café Stena Found: cloth fragment investigator: _____ witnesses: 1 (signature) 2 (signature) specialist: (signature) Ye.A. (Surname illegible) date sealed: 11.09.14. Crime reporting journal entry No. _____ 20____ (Figure 1 of the illustrative table appended to the expert conclusion).

- **package 2** (Ministry of Internal Affairs of Ukraine Expert Service bag No. 1451806):

Ministry of Internal Affairs of Ukraine Directorate in _____ city, district _____ Description: Inspection of the incident scene at the Stena rock pub café at vul. Rymarska, Kharkiv found: wallet showing effect of high-temperature action investigator: _____ witnesses: 1 (signature) 2 (signature) specialist: (signature) M.A. Mayer date sealed: 11.09.14. Crime reporting journal entry No. _____ 20____ (Figure 2 of the illustrative table appended to the expert conclusion).

- **package 3** (Ministry of Internal Affairs of Ukraine Expert Service bag No. 0508138):

Ministry of Internal Affairs of Ukraine Directorate in _____ city, district Dzerzhinsky Description: Inspection of the incident scene at the Stena rock pub café at vul. Rymarska, Kharkiv found: fragments of bank notes showing effect of high-temperature action investigator: _____ witnesses: 1 (signature) 2 (signature) specialist: (signature) M.A. Mayer date sealed: 11.09.14. Crime reporting journal entry No. _____ 20____ (Figure 3 of the illustrative table appended to the expert conclusion).

- **package 4** (Ministry of Internal Affairs of Ukraine Expert Service bag No. 1784473):

Ministry of Internal Affairs of Ukraine Directorate in Kharkiv Region city, district Dzerzhinsky district department Description: Inspection of the incident scene at 13 vul. Rymarska, Kharkiv, café Stena found: laptop investigator: _____ witnesses: 1 (signature) 2 (signature) specialist: (signature) Ye.A. (signature illegible) date sealed: 11.09.14. Crime reporting journal entry No. _____ 20__ (Figure 4 of the illustrative table appended to the expert conclusion).

- **package 5** (Ministry of Internal Affairs of Ukraine Expert Service bag No. 1784476):

Ministry of Internal Affairs of Ukraine Directorate in _____ city, district Dzerzhinsky Description: Inspection of the incident scene at the Stena rock pub café at vul. Rymarska, Kharkiv found: advertising flyers investigator: _____ witnesses: 1 (signature) 2 (signature) specialist: (signature) M.A. Mayer date sealed: 11.09.14. Crime reporting journal entry No. _____ 20__ (Figure 5 of the illustrative table appended to the expert conclusion).

- **package 6** (Ministry of Internal Affairs of Ukraine Expert Service bag No. 1968523):

Ministry of Internal Affairs of Ukraine Directorate in _____ city, district Dzerzhinsky Description: Inspection of the incident scene at the Stena rock pub café at vul. Rymarska, Kharkiv found: 3 laptops – 2 chargers investigator: _____ witnesses: 1 (signature) 2 (signature) specialist: (signature) M.A. Mayer date sealed: 11.09.14. Crime reporting journal entry No. _____ 20__ (Figure 6 of the illustrative table appended to the expert conclusion).

- **package 7** (Ministry of Internal Affairs of Ukraine Expert Service bag No. 1968085):

Ministry of Internal Affairs of Ukraine Directorate in _____ city, district Dzerzhinsky Description: Inspection of the incident scene at the Stena rock pub café at vul. Rymarska, Kharkiv found: advertising flyers investigator: _____ witnesses: 1 (signature) 2 (signature) specialist: (signature) M.A. Mayer date sealed: 11.09.14. Crime reporting journal entry No. _____ 20__ (Figure 7 of the illustrative table appended to the expert conclusion).

- **package 10** (Ministry of Internal Affairs of Ukraine Expert Service bag No. 0509977):

Ministry of Internal Affairs of Ukraine Directorate in _____ city, district _____ Description: Inspection of the incident scene after explosion at the Stena pub found: fluid residue from the inner surface of the bar investigator: _____ witnesses: 1 (signature) 2 (signature) specialist: (signature) date sealed: 11.10.14. Crime reporting journal entry No. _____ 20__ (Figure 10 of the illustrative table appended to the expert conclusion).

- **package 11** (Ministry of Internal Affairs of Ukraine Expert Service bag No. 0509968):

Ministry of Internal Affairs of Ukraine Directorate in _____ city, district _____ Description: Inspection of the incident scene after explosion at the Stena pub found: fragment of cloth with pocket containing a sheet of paper investigator: _____ witnesses: 1 (signature) 2 (signature) specialist: (signature) date sealed: 11.10.14. Crime reporting journal entry No. _____ 20__ (Figure 11 of the illustrative table appended to the expert conclusion).

- **package 12** (Ministry of Internal Affairs of Ukraine Expert Service bag No. 0509969):

Ministry of Internal Affairs of Ukraine Directorate in _____ city, district _____ Description: Inspection of the incident scene after explosion at the Stena pub found: magnet fragments investigator: _____ witnesses: 1 (signature) 2 (signature) specialist: (signature) date sealed: 11.10.14. Crime reporting journal entry No. _____ 20__ (Figure 12 of the illustrative table appended to the expert conclusion).

- **package 13** (Ministry of Internal Affairs of Ukraine Expert Service bag No. 0509979):

Ministry of Internal Affairs of Ukraine Directorate in _____ city, district _____
Description: Inspection of the incident scene after explosion at the Stena pub found: metal fragments with grooving investigator: _____ witnesses: 1 (signature) 2 (signature) specialist: (signature) date sealed: 11.10.14. Crime reporting journal entry No. _____ 20____ (Figure 13 of the illustrative table appended to the expert conclusion).

- **package 14** (Ministry of Internal Affairs of Ukraine Expert Service bag No. 1158952):

Ministry of Internal Affairs of Ukraine Directorate in _____ city, district _____
Description: Inspection of the incident scene after explosion at the Stena pub found: fabric fragments investigator: _____ witnesses: 1 (signature) 2 (signature) specialist: (signature) date sealed: 11.10.14. Crime reporting journal entry No. _____ 20____ (Figure 14 of the illustrative table appended to the expert conclusion).

- **package 15** (Ministry of Internal Affairs of Ukraine Expert Service bag No. 1158955):

Ministry of Internal Affairs of Ukraine Directorate in _____ city, district _____
Description: Inspection of the incident scene after explosion at the Stena pub found: square metal fragment investigator: _____ witnesses: 1 (signature) 2 (signature) specialist: (signature) date sealed: 11.10.14. Crime reporting journal entry No. _____ 20____ (Figure 15 of the illustrative table appended to the expert conclusion).

- **package 16** (Ministry of Internal Affairs of Ukraine Expert Service bag No. 1158953):

Ministry of Internal Affairs of Ukraine Directorate in _____ city, district _____
Description: Inspection of the incident scene after explosion at the Stena pub found: metal fragments investigator: _____ witnesses: 1 (signature) 2 (signature) specialist: (signature) date sealed: 11.10.14. Crime reporting journal entry No. _____ 20____ (Figure 16 of the illustrative table appended to the expert conclusion).

- **package 17** (Ministry of Internal Affairs of Ukraine Expert Service bag No. 0508137):

Ministry of Internal Affairs of Ukraine Directorate in _____ city, district Dzerzhinsky
Description: Inspection of the incident scene at the Stena rock pub café at vul. Rymarska, Kharkiv found: red and black flag investigator: _____ witnesses: 1 (signature) 2 (signature) specialist: (signature) M.A. Mayer date sealed: 11.09.14. Crime reporting journal entry No. _____ 20____ (Figure 17 of the illustrative table appended to the expert conclusion).

- **Package No. 8** is a white quadrangular paper envelope measuring 155 x 113 (Figure 8 of the illustrative table appended to the expert conclusion). On the front of the envelope there are inscriptions:

- in black print at the top left corner: "Sender address, post code," followed by five dotted lines; at the bottom right corner: "Recipient address," followed by six dotted lines.

- In blue ink handwriting: "11.09.14 Inspection of the incident scene at the Stena rock pub café at 13 vul. Rymarska, Kharkiv: cylindrical metal fragment. Witnesses: 1. (signature) 2. (signature) Specialist: (signature) M.A. Mayer. Investigator:"

On the back, there are inscriptions in black print and a bar code.

- **Package No. 9** is a cylindrical container made of clear colorless glass 30 mm in diameter and 60 mm in height (Figure 9 of the illustrative table appended to the expert conclusion). The top of the container is sealed with a grey rubber cap.

There is a white piece of paper – label – affixed to the side of the container with clear polymeric adhesive tape (scotch tape). The label bears inscriptions handwritten in blue ink: “*Incident scene inspection at 13 vul. R. Rollana, Kharkiv. Witnesses: 1. (signature) 2. (signature) Participant: (signature) A.S. Matyan Investigations department investigator (signature)*”

- **Package No. 18** is a partially transparent dark grey polymeric bag tied with a piece of white string at the neck (Figure 18 of the illustrative table appended to the expert conclusion). The ends of the string are attached to a rectangular piece of white paper additionally covered with clear polymeric adhesive tape (scotch tape), the label. The label bears handwritten inscriptions and signatures in blue ink: “*Incident scene inspection at 13 vul. Romena Rollana, Kharkiv. Witnesses: 1. (signature) 2. (signature) Participants: 1. (signature) 2. (signature) Investigator (signature) Toporkov*”

- **Package No. 19** is a semi-transparent blue polymeric bag tied with a piece of white string at the neck (Figure 19 of the illustrative table appended to the expert conclusion). The ends of the string are attached to a rectangular piece of white paper, the label. The label bears handwritten inscriptions in blue ink: “*personal effects given up voluntarily by A.L. Kiseleva.*” The label also bears the blue round seal of the Dzerzhinsky district investigations department, No. 08804175.

- **Package No. 20** is a semi-transparent blue polymeric bag tied with a piece of white string at the neck (Figure 20 of the illustrative table appended to the expert conclusion). The ends of the string are attached to a rectangular piece of white paper, the label. The label contains handwritten explanatory notes in blue ink: “*personal effects given up voluntarily by A.L. Kiseleva.*” The label also bears the blue round seal of the Dzerzhinsky district investigations department, No. 08804175.

- **Package No. 21** is a semi-transparent blue polymeric bag tied with a piece of white string at the neck (Figure 21 of the illustrative table appended to the expert conclusion). The ends of the string are attached to a rectangular piece of white paper, the label. The label contains handwritten explanatory notes in blue ink: “*personal effects given up voluntarily by V.V.Svyatash.*” The label also bears the blue round seal of the Dzerzhinsky district investigations department, No. 08804175.

- **Package No. 22** is a semi-transparent blue polymeric bag tied with a piece of white string at the neck (Figure 22 of the illustrative table appended to the expert conclusion). The ends of the string are attached to a rectangular piece of white paper, the label. The label contains handwritten explanatory notes in blue ink: “*personal effects given up voluntarily by R.V. Maslov.*” The label also bears the blue round seal of the Dzerzhinsky district investigations department, No. 08804175.

- **Package No. 23** is a semi-transparent blue polymeric bag tied with a piece of white string at the neck (Figure 23 of the illustrative table appended to the expert conclusion). The ends of the string are attached to a rectangular piece of white paper, the label. The label contains handwritten explanatory notes in blue ink: *“personal effects given up voluntarily by V.V.Svyatash.”* The label also bears the blue round seal of the Dzerzhinsky district investigations department, No. 08804175.

- **Package No. 24** is a semi-transparent blue polymeric bag tied with a piece of white string at the neck (Figure 24 of the illustrative table appended to the expert conclusion). The ends of the string are attached to a rectangular piece of white paper, the label. The label contains handwritten explanatory notes in blue ink: *“personal effects given up voluntarily by R.V. Maslov.”* The label also bears the blue round seal of the Dzerzhinsky district investigations department, No. 08804175.

- **Package No. 25** is a semi-transparent blue polymeric bag tied with a piece of white string at the neck (Figure 25 of the illustrative table appended to the expert conclusion). The ends of the string are attached to a rectangular piece of white paper, the label. The label contains handwritten explanatory notes in blue ink: *“seized during inspection on 11.10.14 at 3-A vul. Balakireva, Kharkiv. Witnesses: 1. (signature) 2. (signature) Investigator (signature).”* The label also bears the blue round seal of the Dzerzhinsky district investigations department, No. 08804175.

The packages have not been disturbed, providing safe storage for the investigated objects and preventing unauthorized access.

The following was retrieved from the packages upon opening:

- **package No. 1:** fragment of clothes fabric with pocket opening - investigated object No. 1 (Figure 26 of the illustrative table appended to the expert conclusion);
- **package No. 2:** a damaged wallet with remnants of wire - investigated object No. 2 (Figure 27 of the illustrative table appended to the expert conclusion);
- **package No. 3:** bank notes (hryvnia) in a damaged (charred) condition - investigated object No. 3 (Figure 33 of the illustrative table appended to the expert conclusion);
- **package No. 4:** a Lenovo laptop - investigated object No. 4 (Figures 34, 35 of the illustrative table appended to the expert conclusion);

- **package No. 5:** four rectangular emblems and four shield-shaped emblems – group of investigated objects No. 5 (Figure 36 of the illustrative table appended to the expert conclusion);
- **package No. 6:** three laptops and two chargers – group of investigated objects No. 6 (Figures 37- 45 of the illustrative table appended to the expert conclusion);
- **package No. 7:** a short blue synthetic jacket with zip fastening - investigated object No. 7 (Figure 46 of the illustrative table appended to the expert conclusion);
- **package No. 8:** a cylindrical metal item of complex design - investigated object No. 8 (Figures 47 – 49 of the illustrative table appended to the expert conclusion);
- **package No. 9:** one metal fragment - investigated object No. 9 (Figure 50 of the illustrative table appended to the expert conclusion);
- **package No. 10:** a gauze pad with dark fluid residue - investigated object No. 10 (Figure 51 of the illustrative table appended to the expert conclusion);
- **from package No. 11:** a piece of pale-green fabric with a pocket - investigated object No. 11 (Figure 52 of the illustrative table appended to the expert conclusion);
- **package No. 12:** seven black metal fragments with the properties of a permanent magnet - investigated object No. 12 (Figure 53 of the illustrative table appended to the expert conclusion);
- **package No. 13:** pale-grey metal fragments – group of investigated objects No. 13 (Figures 54 - 61 of the illustrative table appended to the expert conclusion);
- **package No. 14:** fragments (torn pieces) of different types of stained and damaged fabric - investigated object No. 14 (Figure 62 of the illustrative table appended to the expert conclusion);
- **package No. 15:** a quadrangular metal plate - investigated object No. 14 (Figure 63 of the illustrative table appended to the expert conclusion);
- **package No. 16:** metal fragments (debris) with damage and fragments (torn pieces) of fabric – group of investigated objects No. 16 (Figures 64 - 68 of the illustrative table appended to the expert conclusion);
- **package No. 17:** a red-and-black flag - investigated object No. 17 (Figure 69 of the illustrative table appended to the expert conclusion);
- **package No. 18:** a scarf and a man’s tracksuit top – group of investigated objects No. 18 (Figure 70 of the illustrative table appended to the expert conclusion);
- **package No. 19:** a pair of black ladies’ ankle boots – group of investigated objects No. 19 (Figure 71 of the illustrative table appended to the expert conclusion);

- **package No. 20:** a black ladies' knitted top - investigated object No. 20 (Figure 72 of the illustrative table appended to the expert conclusion);
- **package No. 21:** a black and brown ladies' handbag - investigated object No. 21 (Figure 73 of the illustrative table appended to the expert conclusion);
- **package No. 22:** a white plastic bag with a pair of men's shoes, socks and belt - investigated object No. 22 (Figure 74 of the illustrative table appended to the expert conclusion);
- **package No. 23:** a pair of blue jeans - investigated object No. 23 (Figure 75 of the illustrative table appended to the expert conclusion);
- **package No. 24:** a pair of blue jeans, a white short-sleeve T-shirt and a grey jumper – group of investigated objects No. 24 (Figures 76, 77 of the illustrative table appended to the expert conclusion);
- **package No. 25:** a gauze pad - investigated object No. 25 (Figure 78 of the illustrative table appended to the expert conclusion);

The objects submitted for investigation correspond to their description in the resolution requesting forensic analysis.

Separate investigation of submitted objects [1 – 12]

An inspection of **investigated objects No. 1, 4 – 7, 17, 18, 20, and 23** established the following:

- there is no damage to the surface of these objects typical of explosive effects (brisant, incendiary and thermal action);
- there are no metal, plastic, stone or other items among these investigated objects that may be related or be part of an explosive device;
- on the surface of the investigated objects there are different types of deposits which may contain blast products; samples were collected from all the objects for a chemical investigation (of explosive substances and blast and gunfire products) by sprinkling, scrapings and swabbing (wiping with special gauze pads dabbed in acetone);

An inspection of **investigated objects No. 19, 21, 22, and 24** established the following:

- the outer surface contains mechanical damage (contact, impact, fragmentation) as well as deposits of a white-grey and dark grey substance.
- there are no metal, plastic, stone or other items among these investigated objects that may be related or be part of an explosive device;
- on the surface of the investigated objects there are different types of deposits which may contain blast products; samples were collected from all the objects for a chemical investigation (of explosive substances and blast and gunfire products) by sprinkling, scrapings and swabbing (wiping with special gauze pads dabbed in acetone);

Investigated object No. 2 is a leather wallet with popper fastening. The surface of the wallet has sustained substantial damage of a thermal nature: partial burning of the material (leather), charring, melting, plastic deformation under the impact of high temperature; the wallet doesn't open along the folds as a result of material sticking (fused) together. On the surface of the wallet there are burnt fragments of brown metal wires stuck together (not responsive to a permanent magnetic field) with remnants of plastic insulation, a 3.5 TRS type of coaxial electric contact (connector) is fixed to the ends of the wires (for audio signal transmission, probably for headphones or telephone accessories). Opening the wallet along the folds (using a paper knife) established that the wallet contains business cards, bankcards and promotional postcards. No other items or fragments were found that could be related to an explosive device.

Group of investigated objects No. 3 amounts to paper bank notes (Ukrainian hryvnia). Most of the notes have burnt edges; each note surface has dark grey and black deposits of varying thickness.

Investigated object No. 8 is a light-grey cylindrical object of complex design made of metal (not responsive to a permanent magnetic field). Dimensions: length: 50.5 mm, maximum diameter: 30.5 mm, mass: 38 grams. The surface of the investigated object has damage typical of an explosive effect: displacement, plastic deformation, cracking, fissure, thinning along the edges and roughness (typical of viscous rupture). The investigated object can be taken apart to three components:

- a part shaped like a 20 mm cylindrical cap, a smaller, 22 mm external diameter (of the casing) and a 17 mm internal diameter – the cap. The bottom section has a circular protrusion 26 mm in diameter and 3.3 mm in height, the outer lateral surface shows parallel longitudinal grooves of industrial origin, the inner surface shows grooving on the right side 17 mm in diameter. Inside the cap, on the bottom, there is a black deposit similar in appearance to soot.

- A cylindrical part of complex configuration, 38 mm long with the maximum diameter of 26.5 mm – bushing. The part has the following characteristic structural features:

- Two criss-cross slots located at a right angle to each other, in the top section – to fit a metal element and cutter;
- External grooving in the top section 17 mm in diameter – to fit the cap;
- External grooving in the bottom section 14 mm in diameter – to fit a grooved bushing;

- A rectangular 6 x 3 mm through opening – to fit a safety catch;
- An opening along the line of symmetry 7.5 mm in diameter (to fit a firing pin and spring);
- A cylindrical part of complex configuration 24 mm in length with the maximum diameter of 30.5 mm – a grooved bushing with the fragment of a casing inside. This part has the following characteristic structural features:
 - A protrusion in the upper section of the part in the shape of a congruent hexagon (key slot) with the side length of 15 mm and the maximum size (distance between two opposite angles) 30.5 mm
 - External grooving 24.5 mm in diameter (to fit a bushing in mine casing);
 - A metal washer (seal)
 - A circular protrusion in the bottom section 23 mm in diameter and 2.2 mm in height;
 - A longitudinal through opening 13.5 mm in diameter (to fit a firing pin and spring);

The outer and inner surfaces of the parts show black deposits similar in appearance to soot, with the deposits on the inner surface of the investigated object visibly thicker than those on the outer surface.

Investigated object No. 9 is an 11 x 9 mm irregularly shaped grey metal fragment (not responsive to a permanent magnetic field) weighing less than 1 gram. The surface and edges of the investigated object show damage characteristic of an explosive effect: displacement, plastic deformation, cracking, fissure, thinning along the edges and roughness (typical of viscous rupture). The surface of the investigated object shows signs of industrial treatment: remnants of parallel longitudinal grooves and a groove section with a right-angled crossing.

Investigated object No. 10 is a white gauze pad with a grey and white deposit.

Investigated object No. 11 is a piece of a white and grey synthetic fabric with a fragment of a black shoelace with a plastic catch. The investigated object shows damage in the form of torn fabric, a ragged edge with fraying and poorly visible melting, which may point to the brisant and thermal effects of detonating an explosive substance.

Group of investigated objects No. 12 amounts to seven black metal fragments having properties of a permanent magnet. The fragments have an irregular shape, and the surface and edges of the fragments show damage characteristic of an explosive effect: displacement, plastic deformation, cracking, fissure, thinning along the edges and roughness (typical of viscous rupture).

The surface of the investigated object retains sections of industrial origin, with a smooth surface showing signs of industrial treatment, and visible black deposits that look like soot.

Group of investigated objects No. 13 amounts to metal fragments with the total mass of 7 grams (Figures 55-61 of the illustrative table appended to the expert conclusion). All the fragments show damage such as displacement and plastic deformation, as well as an uneven surface showing features of deformation like cracking, fissure, thinning along the edges and roughness (typical of viscous rupture), some fragments have poorly visible sections with changing color. The surface of these investigated objects show grey and black deposits that look like soot.

After an initial visual inspection, the objects were divided into the following groups according to their established structural and morphological features:

– **group of investigated objects 13.1:** nine irregularly shaped metal fragments (not responsive to a permanent magnetic field) having distinct external (protruding) and internal (concave) sides displaying features of industrial origin:

- on the outer side: parallel transverse grooves (traces of mechanical treatment) about 0.1 mm wide, with some fragments showing 6-7 mm wide right-angled indentations with remnants of bevels.

- on the inner side: remnants of grooving and, apart from the abovementioned deformations, damage of a thermal nature: microsections with traces of melting (visible under a microscope).

– **investigated object No. 13.2:** a flattened cylindrical metal fragment (responsive to a permanent magnetic field) 6 mm in diameter and 9 mm long, the lateral side of which shows characteristic features of industrial origin: a fragment of external grooving. Inside the grooves there are visible beige and brown deposits.

– **group of investigated objects No. 13.3:** three metal fragments (not responsive to a permanent magnetic field) having distinct external (protruding) and internal (concave) sides; the external side shows characteristic features of industrial origin - parallel transverse grooves (traces of mechanical treatment) about 0.1 mm wide. Apart from the abovementioned deformations, group No. 13.3 objects show visible damage of a thermal nature: microsections with traces of melting (visible under a microscope).

– **investigated object No. 13.4** is a black metal fragment having properties of a permanent magnet. The fragment has an irregular shape, and its surface and edges show damage characteristic of an explosive effect: displacement, plastic deformation, cracking, fissure, thinning along the edges and roughness (typical of viscous rupture). The surface of the investigated object retains sections of industrial origin, with a smooth surface showing traces of industrial treatment and visible black deposits that look like soot.

– **group of investigated objects No. 13.5** is two metal fragments (responsive to a permanent magnetic field) in the form of fragments of a cylindrically coiled spring about 0.1 mm in diameter.

Group of investigated objects No. 14 amounts to pieces of various type fabric. All the objects in this group show damage in the form of torn fabric, ragged edges with fraying and poorly visible melting, which may point to the brisant and thermal effects of detonating an explosive substance. On the surface of the investigated objects there are thick deposits of dark grey, white, brown and black substances with varying degrees of dispersion.

Investigated object No. 15 is a metal plate fragment mm thick of a rectangular (nearly square) shape, measuring 94 x 95 mm with a mass of 180 grams. In the center of the investigated object there is a through hole 44 mm in diameter, and at the distance of 9 mm from the object's outer faces there are three through holes 6 mm in diameter. The object shows displacement and plastic deformation, as well as an uneven surface showing damage of mechanical origin (impact, contact) as well as roughness (typical of viscous rupture). The surface shows extensive grey and black soot-like deposits.

Group of investigated objects No. 16 amounts to metal fragments with the total mass of 208 grams (Figures 64 – 68 of the illustrative table appended to the expert conclusion) bits of torn black fabric with the mass of 4 grams.

All the metal fragments show displacement and plastic deformation, as well as an uneven surface showing features of deformation like cracking, fissure, thinning along the edges and roughness (typical of viscous rupture), some fragments have poorly visible sections of changing color and damage of mechanical (impact, contact) origin. On the surface of the fragments there are grey and black soot-like deposits as well as reddish-brown and ginger-colored deposits resembling products of ferrum-based alloy corrosion (rust).

After an initial visual inspection, the objects were divided into the following groups according to their established structural and morphological features:

– **group of investigated objects No. 16.1:** thirteen metal plate fragments (responsive to a permanent magnetic field) with the maximum thickness of 2 mm having distinct external (protruding) and internal (concave) sides displaying features of industrial origin, such as remnants of rivets and corresponding holes arranged in a certain way, edges retaining a regularly shaped configuration of industrial origin and (on the outer surface of some fragments) fragments of grey paintwork.

On the inner side, apart from the abovementioned general deformation, there is damage of thermal origin: microsections with traces of melting (visible under a microscope).

– **investigated object No. 16.2** is a 0.5 mm thick irregularly shaped metal plate fragment (not responsive to a permanent magnetic field) measuring 16.5 x 8.5 mm, with a mass of less than 1 gram. The object shows displacement and plastic deformation, as well as an uneven surface showing damage of mechanical origin (impact, contact) and roughness (typical of viscous rupture). On the outer side there are parallel transverse grooves (traces of mechanical treatment) about 0.1 mm wide. On the surface, there are grey and black soot-like deposits.

– **investigated object No. 16.3** is a flattened cylindrical metal fragment (responsive to a permanent magnetic field) 6 mm in diameter and 12 mm in length, the lateral surface of which has the characteristic features of industrial origin: external grooving. Inside the grooves there are visible reddish-brown deposits resembling products of ferrum-based alloy corrosion (rust).

– **investigated object No. 16.4** is an irregularly shaped metal fragment (not responsive to a permanent magnetic field) measuring 7.5 x 5.5 mm with a mass of less than 1 gram. The object shows displacement and plastic deformation, as well as an uneven surface showing damage of mechanical origin (impact, contact) and roughness (typical of viscous rupture). On the surface, there are grey and black soot-like deposits.

– **investigated object No. 16.5** is a black metal fragment having properties of a permanent magnet. The fragment has an irregular shape, with the surface and edges showing damage characteristic of an explosive effect: displacement deformation, plastic deformation, cracking, fissure, thinning along the edges and roughness (typical of viscous rupture). The surface of the investigated object retains sections of industrial origin, with a smooth surface showing traces of industrial treatment and visible black soot-like deposits.

– **investigated group of objects No. 16.6** amounts to fragments of torn black fabric showing damage in the form of tearing, fraying, charring and melting, which is typical of the brisant and thermal explosive effects. Group of investigated objects No. 16.6 has a mass of 4 grams.

Group of investigated objects No. 24 amounts to a pair of blue jeans, a white short sleeve T-shirt and a grey jumper. The jeans show damage in the form of torn trouser leg fabric and a ragged edge with fraying and poorly visible charring, which may be typical of the brisant and thermal effects of a detonated explosive, as well as deposits of a brownish-red substance in the form of spots and stains.

On the surface of this group of investigated objects there are poorly visible deposits of finely dispersed dark grey and white substances.

Group of investigated objects 25 amounts to two white gauze pads with a grey and brown substance residue.

A chemical investigation of explosive substances and products of explosion and gunfire was carried out in order to identify possible traces of explosive substances and blast products on the surfaces and in the composition of investigated objects.

Chemical investigation [3 -7, 10 – 12]

Morphological investigation (microscopy)

A microscopic investigation was conducted with the naked eye in natural daylight, as well as using a 4X magnifying glass and an MSP-1 stereomicroscope (reflected light, 80X magnification).

A morphological investigation was conducted on deposits on the surface of investigated objects in an unaltered condition (as submitted for investigation): objects of chemical investigation No. 1 – 25c.

The morphological investigation established the following:

- 1) investigated objects No. 1c, 4c – 7c, 17c, 18c, 20c and 23c are particles, fragments and fibers with varying degrees of dispersion, color and structure and having morphological properties that do not resemble the equivalent properties of explosive substances and products of explosive transformation, also no traces were found of a thermal effect or metallization characteristic of the destructive action of detonated explosive devices;
- 2) investigated objects No. 2c, 3c, 11c, 19c, 21c, 22c and 24c are particles, fragments and fibers with varying degrees of dispersion, color and structure and having morphological properties that do not resemble the equivalent properties of explosive substances. The composition of these investigated objects includes black particles of an amorphous structure (some with an oily luster) which resemble soot – products of the explosive transformation of detonated substances with a large negative oxygen balance. Traces have been found of melting and charring along the edges and in sections of the underlay, which may be characteristic of a thermal effect. No traces were found of finely dispersed metal particles (metallization);
- 3) investigated objects No. 8c, No. 13.1c – 13.3 c, No. 13.5c, No. 15c, No. 16.1c – 16.3c 16.5c and 16.6c: the bulk of deposits represent a dark grey and black amorphous substance, and the majority of investigated objects show partially transparent amorphous particles and brown-reddish fragments of an irregular and quasi- ellipsoid shape. The composition of investigated objects No. 8c, 16.1c, 16.2c and 16.6c includes separate grey and silver particles of an irregular and quasi-spherical shape and with a shiny surface, resembling metal particles;

- 4) investigated object No. 9c: the bulk of deposits represent a grey and black amorphous substance, most contain brownish-red fragments of a biological origin;
- 5) investigated objects No. 10c and No. 25c: the bulk of deposits represent white and grey particles of a crystal and amorphous structure and varying degrees of transparency; gauze fibers contain poorly visible deposits of a grey amorphously structured substance and occasional grey-silver spherical particles resembling metal particles.
- 6) investigated objects No. 12c, 13.4c and 16.4c: the bulk of deposits represent a grey amorphous substance, and the bulk of investigated objects contain reddish-brown and brownish (rust) particles and fragments, separate grey metal particles, amorphous light-grey to brown particles of an irregular and quasi-ellipsoid shape and occasional grey-silver spherical particles resembling particles of metal.

A comparison between the investigated objects and explosive substance samples from the explosive substance collection held by FEAD FRC at the Main Directorate of the Ministry of Internal Affairs of Ukraine in Kharkiv Region, as well as with the appearance of their explosive transformation products according to data in reference publications, established that their morphological characteristics (state of dispersion, structure, color, shape and particle size) are not identical to the equivalent characteristics of explosive substances.

The characteristics of the dark-grey and black amorphous substance do resemble the characteristics of explosive transformation products of brisant explosive substances with a negative oxygen balance – soot. The separate particles with characteristics of metal particles may be either components of an explosive substance or fragments of metal products affected by the explosion.

Similarities and differences were established in appearance, structural features and color.

Sample preparation

I. Preparing acetone extracts of investigated objects.

- metal fragments (debris) and dry powder were transferred into separate flasks, adding 1 - 10 ml of acetone to each (depending on the volume of investigated objects) and held for 6 hours with periodic shaking.

- the plastic and fabric fragments were sprinkled and scraped, as well as thoroughly wiped with a gauze pad dabbed in acetone; these components were combined and put in separate flasks, adding 5 ml of acetone and held for six hours with periodic shaking.

The solutions obtained were filtered through separate paper filters to obtain respective acetone extracts No. 1.1a – No. 25a, as well as insoluble residue.

II. Preparing water extracts of investigated objects.

The insoluble residues obtained at the previous stage along with respective gauze pads were transferred into separate flasks, adding 15 ml of distilled water to each and held for 6 hours with periodic shaking. After steeping, the substances obtained were filtered through separate paper filters to obtain respective water extracts No. 1.1w – No. 25w, as well as respective residues, insoluble either in acetone or water.

III. Retrieving metal particles

The irregularly shaped grey particles with a shiny surface found in the composition of investigated objects No. 8c, No. 10c, No. 12c, No. 13.4c, 16.1c, 16.2c, 16.4c and 25c, which resemble metal particles were retrieved from the composition of respective residues using a preparation needle and transferred onto separate glass plates.

All the investigated objects and their respective acetone extracts were inspected under ultraviolet light using an OLD-41 emitter, in order to determine the possible presence of fuel and lubricant substances and objects of biological origin. During the inspection, the acetone extracts of investigated objects were monitored for the presence or absence of luminescence.

Capillary chemical reactions

Qualitative chemical reactions were conducted in order to determine the characteristic components of gunfire products in the composition of investigated objects. Investigation followed the same algorithm separately for each acetone and water extract.

I. Qualitative reactions with acetone extracts.

Each acetone extract was divided into five equal aliquots, three of which were subjected to qualitative reactions, and the other two aliquots were used for thin-layer vertical chromatography investigations.

1. Determining organic oxidizer compounds (soluble in acetone)

An aliquot of the acetone extract was steamed in a jet of cool air until a dry residue, to which 1 drop was added of a 1 % solution of diphenylamine in concentrated sulphuric acid. The appearance of spots and dark-blue jets points to the presence of oxidizers.

2. Determining nitroaromatic compounds

An aliquot of the acetone extract was steamed in a jet of cool air until a dry residue, to which 1 drop of acetone was added along with 1 drop of a 1 per cent solution of natrium hydroxide in ethanol. The appearance of red and brown or blue coloring points to the presence of trinitro- or dinitroaromatic compounds, respectively.

3. Determining peroxide compounds

3.1. An aliquot of the acetone extract was transferred into a tube and steamed until the volume of 0.5 ml, to which 0.5 ml was added of a 10% sulphuric acid solution. Then 0.5 [ml] of diethyl ether was added to the resulting mixture along with several drops of a 5% potassium dichromate solution in water, after which the contents of the tube were gently shaken. After the mixture separated into the water and ether phases, it was monitored for changes in color. The appearance of blue coloring in the ether layer points to the presence of peroxide compounds.

3.2. An aliquot of the acetone extract and steamed until the volume of 0.1 ml, to which 1 ml was added of a 10% potassium iodine solution in water, oxidized by vinegar acid, carefully shaken. The appearance of yellow coloring points to the presence of peroxide compounds.

The results of investigation using the qualitative reactions method are presented in Table 1.

Table 1

Results of investigating acetone extracts of investigated objects using the qualitative reactions method

Extract No	Reaction to			
	Oxidizers	Nitroderivatives of aromatic compounds	Peroxide compounds	Presence of luminescence
1a, 4a, 5a, 6a, 7a, 11a, 17a, 18a, 20a, 23a, 25a	-	-	-/-	-
8a, 9a, 10a, 12a, 13.1a, 14a, 16.1a, 16.2a, 16.3a, 16.4a, 16.5a, 16.6a, 19a, 22a, 24a	+	+	-/-	-
3a, 13.3a, 13.4a	-	+	-/-	-
13.2a	+	-	-/-	-
13.5a, 15a	+	-	-/-	-
21a	+	+	-/-	+

II. Qualitative reactions with water extracts

One drop of investigated water extracts was entered on strips of the universal indicator paper LACHEMA (PND 50-975-84 pH 0-12), comparing the resulting changes in color to the standard scale.

Each of the investigated water extracts was divided into eight aliquots which were subjected to the following reactions:

1. Determining non-organic oxidizer compounds (soluble in water)

An aliquot of the water extract was steamed in a jet of cool air until a dry residue, to which 2 drops were added of a 1% solution of diphenylamine in concentrated sulphuric acid. The appearance of spots and dark-blue jets points to the presence of oxidizers.

2. Determining nitrite ions and nitrate ions

An aliquot of the water extract was transferred onto a glass plate, steamed in a jet of warm air until the volume of several drops, to which several granules were added of a solid Griess reagent. The appearance of a pink color points to the presence of nitrite ions.

Zinc dust was added to the obtained reaction medium. The development and appearance of a dark red color points to the presence of nitrate ions.

3. Determining ammonium cations

An aliquot of the water extract was transferred to a tube, to which 3 drops of the Nessler reagent were added. The appearance of a red and brown residue or a dark yellow color points to the presence of ammonium cations.

4. Determining potassium cations

An aliquot of the water extract was transferred into a porcelain cup and steamed until a dry residue. The residue was fried for five minutes to release possible ammonia salts which produce a similar reaction with potassium. After cooling, the residue was dissolved in a drop of distilled water, to which 1 drop was added of a saturated sodium hexanitrocobaltate solution oxidized by vinegar acid. The obtained substance was investigated under the microscope: the appearance of a residue in the form of yellow cubes and "friends" points to the presence of potassium cations.

5. Determining chlorate anions

An aliquot of the water extract was transferred onto a glass plate, steamed in a jet of warm air until dry, to which 3 drops were added of a 0.1% aniline sulphate solution in sulphuric acid. The appearance of a dark blue color points to the presence of chlorate anions.

6. Determining carbonate anions and sulphate anions

An aliquot of the water extract was transferred into a tube, adding 3 drops of a 5% barium chloride solution in water. The appearance of a white residue points to the presence of carbonate anions and sulphate anions.

Five drops of a 1 per cent hydrochloric acid solution was added to the obtained residue. Subsequent complete dissolution of the residue points to the presence of carbonate anions, gradual partial dissolution of the residue points to the joint presence of carbonate anions and sulphate anions.

7. Determining chloride anions

An aliquot of the water extract was transferred into a tube, adding 3 drops of a 5% silver nitrate solution in water. The appearance of a white residue points to the presence of chloride anions.

8. Determining metallic aluminum

A drop of a 10% potassium hydroxide solution in water was added to the metal particles extracted during sample preparation (see stage III). Gas bubbles were observed under the microscope forming around each of the investigated particles, which allows for the confirmation that these particles are those of an aluminum-based metal alloy.

The results of investigation using the qualitative reactions method are presented in Table 2

Results of investigating water extracts of investigated objects using the qualitative reactions method

Extract No	Reaction to										
	pH	Oxidizers	Nitrite anion	Nitrate anion	Ammonium cation	Potassium cation	Chlorate anion	Carbonate anion	Sulphate anion	Chloride anion	Aluminum (residue)
1a-12a, 17a, 20a, 23a	<7	+	-	+	-	+	-	+	+	+	-
13.1a-13.5a, 14a, 15a, 16.1a-16.6a	<7	+	+	+	+	+	-	+	+	+	+
24a	≈ 7	+	-	+	+	+	-	+	-	-	+
5a, 18a, 25a	≈ 7	-	-	-	-	-	-	+	-	-	-

III. Investigation of residues insoluble in acetone and water

The respective residue was transferred onto a glass plate and investigated using an MSP-1 stereomicroscope.

Shapeless black and grey-brown particles of an amorphous and polymeric nature were observed under the microscope. For all the investigated objects, the particles partially disintegrated under the action of weak and concentrated hydrochloric and sulphuric acid solutions, which does not allow their unqualified identification as fragments of soot.

Investigation using the thin-layer chromatography method

The method of vertical single-dimension straight-phase thin-layer chromatography (TLC) was used to determine traces of explosive substances, stabilizers and components of smokeless powder and gunpowder in the content of investigated objects.

For this, aliquots of the acetone extracts obtained in the process of sample preparation were steamed in a jet of cool air until the volume of several microdrops and using a capillary dropper were entered onto the starting line of chromatographic plates at the distance of 15 mm from the bottom edge of the plate.

I. Determining explosive substances, diphenylamine, and nitroglycerine

Chromatography was conducted under these conditions:

Stationary phase - Sorbfil chromatographic plates PTSX-P-A-UF (TU 26-11-17-89) measuring 10 x 10 cm with the working absorbent layer: silicagel STX-1A (layer thickness: 90...120 nm, grain fraction: 5.....17 nm) with ciliciumdioxide-based binder with the addition of luminophore at 254 nm.

Mobile phase (eluent) - acetone-toluene-hexane (1:1:2)

Preparatory Stages - cleansing with acetone-toluene-hexane (1:1:2) eluent, drying for 30 minutes at 100 C, removing the top and bottom edges of the plate each 5 mm thick and bottom corners 1 mm wide.

[seal:] Forensic Research Center No. 12 Kharkiv Region
Main Directorate Ministry of Internal Affairs of Ukraine

Forensic expert [signature]

D.A. Karakurkchi

Eluent front elevation	-	70 mm
Spot detection	-	UV light from an OLD-14 emitter, Muiroir reagent
	-	UV light from an OLD-14 emitter, 5% diphenylamine solution in ethanol, 10% potassium hydroxide solution in ethanol
Reference samples		Acetone extracts of diphenylamine and nitroglycerine

The results of the chromatography investigation are presented in Tables 3 - 5.

Table 3

TLC results in the acetone-toluene-hexane (1:1:2) solvent system, UV light from the OLD-41 emitter, 5% diphenylamine solution in ethanol, 10% potassium hydroxide solution in ethanol

Acetone extract investigated object	Stages of detection					
	Treatment in 5% diphenylamine solution in ethanol		UV treatment		Treatment in 10% potassium hydroxide solution in ethanol	
	Zone coloring	R _f	Zone coloring	R _f	Zone coloring	R _f
TEN	Colorless	0.68	Green	0.68	Green	0.68
Tetryl	Dark yellow	0.47	Yellow-orange	0.47	Red	0.47
Hexogen (RDX)	Light-grey	0.29	Green-grey	0.29	Blue-grey	0.29
Trotyl (TNT)	Yellow-orange	0.78	Orange-brown	0.78	Red-brown	0.78
Octagen	Light grey	0.14	Green-grey	0.14	Blue-grey	0.14
2a, 8a, 9a, 10a, 12a, 13.1a, 13.2a, 14a, 16.1a, 16.2a, 16.3a, 16.4a, 16.5a, 16.6a, 19a, 22a	Light-grey	0.29	Green-grey	0.29	Blue-grey	0.29
	Yellow-orange	0.78	Orange-brown	0.78	Red-brown	0.78
1a, 4a, 5a, 6a, 11a, 17a, 18a, 20a, 23a, 25a	-	-	-	-	-	-
3a, 7a, 24a	Yellow-orange	0.78	Orange-brown	0.78	Red-brown	0.78

TLC results in the acetone-toluene-hexane (1:1:2) solvent system, UV light from the OLD-41 emitter, Muiroir reagent

Investigated object (acetone extract No)	Stages of detection			
	UV light		Treatment with Muiroir reagent	
	Zone coloring	R _f	Zone coloring	R _f
Reference sample: diphenylamine	Grey	0.78	Blue	0.78
1a - 25a	-	-	-	-

The investigation established that the chromatograms of acetone extracts shows zones with the coloring and chromatographic mobility value R_f characteristic of :

- extracts 2a, 8a, 9a, 10a, 12a, 13.1a, 13.2a, 14a, 16.1a, 16.2a, 16.3a, 16.4a, 16.5a, 19a, 22a and 25a - trotyl/TNT and hexogen/RDX;
- extracts 3a, 7a, 24a - trotyl/TNT.

II. Determining sulphur

Chromatography was conducted under the following conditions:

Stationary phase - Sorbfil chromatographic plate PTSX-P-A-UF (TU 26-11-17- 89) measuring 10 x 10 cm with the working absorbent layer: silicagel STX-1A (layer thickness: 90...120 nm, grain fraction: 5.....17 nm) with a ciliciumdioxide-based binder and the addition of luminophore at 254 nm.

Mobile phase - heptane

Preparatory - cleansing with heptanes eluent, drying for 30 minutes at 100 C, removing the top and bottom edges of the plate 5 mm thick each and bottom corners 1 mm wide.

Stages

Eluent front elevation - 70 mm

Spot detection pulverization by 5% water solution of silver nitrate, activation by UV light from an OLD-41 emitter

Reference samples Acetone extract of Sulphur

Table 5

TLC results in the heptane solvent system

Investigated object (acetone extract No)	Stages of detection			
	Treatment in 5% water solution of silver nitrate		UV light	
	Zone coloring	R _f	Zone coloring	R _f
Reference sample: acetone extract of sulphur	Yellow-brown	0.95	Brown	0.95
1a - 25a	-	-	-	-

The investigation has established that there is no Sulphur present in the composition investigated objects.

Therefore, after summarizing separate investigations conducted, the following has been established:

- according to the results of morphological investigation: the appearance and morphological characteristics of the amorphous dark grey and black substance found in the composition of investigated objects No. 2c, 3c, 8c – 16c, 19c, 21c, 22c, and 24c are not identical to the equivalent characteristics of explosive Substances, but do resemble products of the blast transformation of brisant explosives with a negative oxygen balance;
- the results of the qualitative capillary analysis show that the composition of investigated objects includes trinitro-derivatives of aromatic compounds: oxidizers, nitrite, nitrate and carbonate anions, ammonium and potassium cations, metallic aluminum, trace amounts of petroleum products (within the margin of error), soot (probably) and other characteristic ions, according to Tables 1 and 2.
- investigation using the thin-layer chromatography method established that
 - the composition of investigated objects No. 2a, 8a, 9a, 10a, 12a, 13.1a, 13.2a, 14a, 16.1a, 16.2a, 16.3a, 16.4a, 16.5a, 19a, and 22a includes traces of explosive substances trotyl (TNT) and hexogen (RDX).
 - the composition of extracts No. 3a, 7a, and 24a includes traces of explosive substance trotyl (TNT).

An evaluation of the summarized results of chemical investigation makes it possible to draw the following conclusions:

- investigated objects No. 2, 8, 9, 10, 12, 13.1, 13.2, 14, 16.1, 16.2, 16.3, 16.4, 16.5, 19, and 22 contain traces of the blast products of explosive substances based on trotyl (TNT) and hexogen (RDX);
- investigated objects No. 3, 7, and 24 contain traces of the blast products of explosive substances based on trotyl (TNT).

Despite the fact that a large number of explosive substances contain metallic aluminum (for example, finely dispersed aluminum makes up 17% to 27% of the MS explosive substance), the metal particles of an aluminum-based alloy found in the composition of investigated objects No. 8, No. 10, No. 12, No. 13.4, 16.1, 16.2, No. 16.4, and 16.6 cannot be unequivocally identified with blast products, due to extensive presence of aluminum in the environment; aluminum may also be contained in components of an explosive device (casing, detonator cup, etc) or in the interior of the blast scene (furniture, utensils, electrical parts, etc).

Comparative investigation [1 - 12]

A comparative investigation was conducted to establish whether investigated objects No. 8, No. 9, No. 12, No. 13.1 and No. 16.1 – 16.5 could be grouped, by juxtaposing the characteristics of investigated objects with those of examples of industrially made and improvised explosive devices from the FEAD FRC collection and with the characteristics and descriptions of explosive devices, their components and items of dual use available in reference sources.

A study of the documents, appearance, separate investigations and chemical investigation (of explosive substances and products of explosion and gunfire) established that these investigated objects have the following characteristics:

1. Investigated object No. 8:

- shape: cylindrical;
- material: aluminum-based metal alloy;
- characteristic constructive elements: cap, bushing, grooved bushing, remnants of a cutter and a metallic element;
- evidence of industrial make;
- damage (traces) typical of the brisant and thermal effects of detonated explosive substances;
- damage (traces) typical of mechanical effects (impact, contact);
- present traces of an explosive substance: trotyl (TNT) and hexogen (RDX).

Considering the results obtained, a comparison was made between the characteristics of investigated object No. 8 and those of a reference example from the FEAD FRC collection - a delayed-action VZD-1M fuze (diagrams 1 and 2) - and its descriptions in reference sources.

As a result of comparison, investigated object No. 8 was established to share identical characteristics with those of the top part of delayed action fuze VZD-1M (without part of the casing, the firing pin and spring), which sustained the brisant, incendiary and thermal effects of the explosion, as well as with its description in reference sources.

Similarity was established due to the appearance, material, geometric shape, structural features, size, nature of damage and present traces of an explosive substance based on trotyl (TNT) and hexogen (RDX).

Figure 79. VZD-1M fuze.
 a – appearance; b – cross-section; 1 – cap;
 2 – cutter; 3 – metal element; 4 – catch; 5 – bushing; 6 – grooved bushing; 7 – casing; 8 – firing pin; 9 – combat spring; 10 – membrane; 11 – fuse MD-5M.

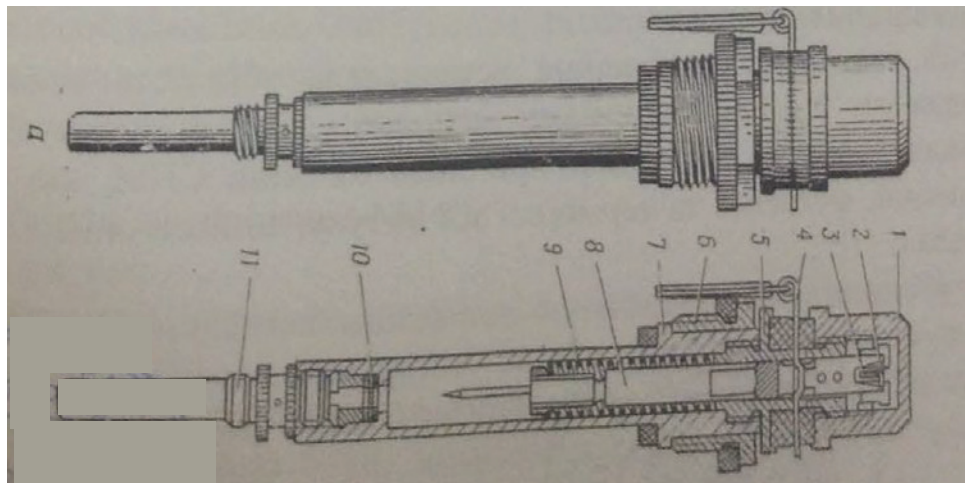

Diagram 1. VZD-1M fuze (external appearance and cross-section)

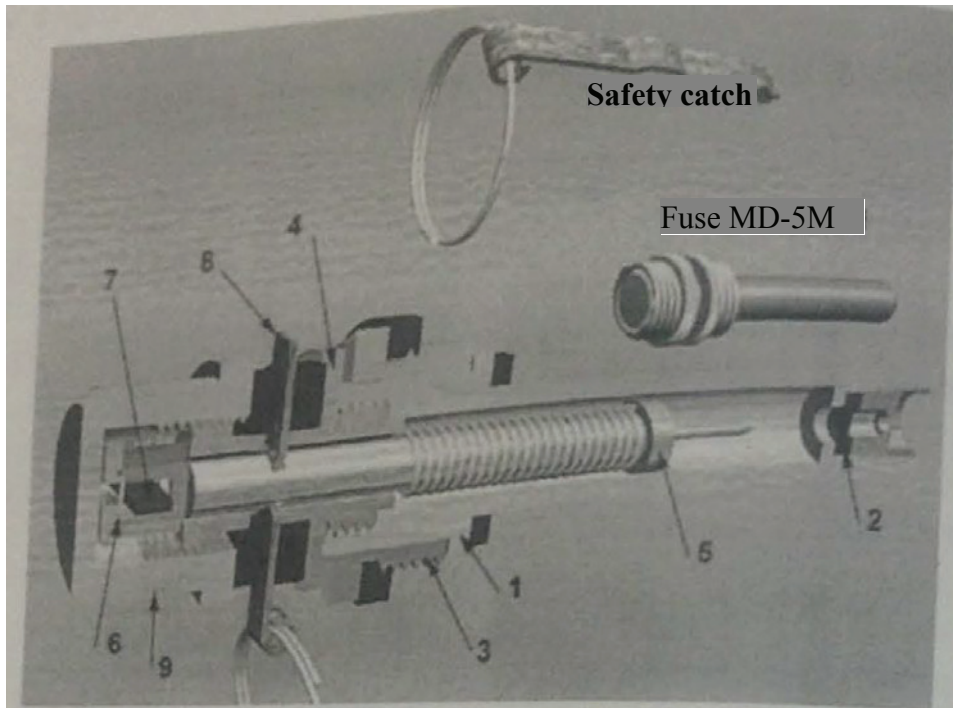

Diagram 2 – VZD – 1M fuze (cross section)

2. Group of investigated objects No. 13.1:

- shape – irregular, with external (protruding) and internal (concave) sides;
- material – aluminum-based metal alloy;
- characteristic structural elements:
 - on the outer side: parallel transverse grooves (signs of industrial treatment) about 0.1 mm wide, some fragments have 6-7 mm wide rectangular indentations with remnants of bevels;
 - on the inner side: remnants of grooving;
- signs of industrial make;
- damage (traces) typical of the brisant and thermal effects of detonated explosive substances;
- present traces of an explosive substance: trotyl (TNT) and hexogen (RDX).

Considering the results obtained, a comparison was made between the characteristics of the group of investigated objects No. 13.1 and those of a reference example from the FEAD FRC collection – the external end of the fuze attachment cup from the casing of the SPM medium limpet mine (diagram 3) and its descriptions in reference sources.

As a result of comparison, group of investigated objects No. 13.1 was established to share identical characteristics with those of the fuze attachment cup from the casing of the SPM medium limpet mine, which sustained the brisant, incendiary, and thermal effects of the explosion, as well as with its description in reference sources.

Similarity was established due to the appearance, geometric shape, structural features, material, size, nature of damage and present traces of an explosive substance based on trotyl (TNT) and hexogen (RDX).

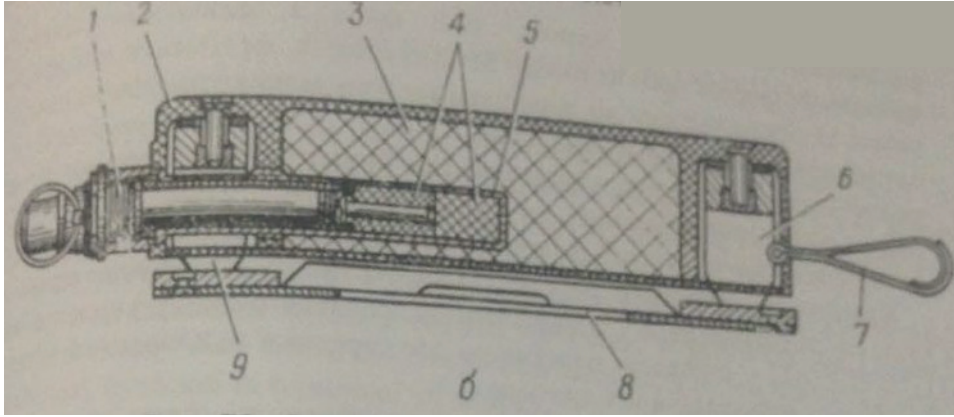

Figure 78. SPM medium limpet mine:

a) general appearance (without steel plate); b) cross-section; 1 – VZD-1M fuze; 2 – casing; 3 – VV charge; 4 – additional detonator; 5 – cup; 6 and 9 – magnets; 7 – string loop; 8 – steel plate.

Diagram 3 – Medium limpet mine (cross-section)

3. Investigated objects No. 13.2 and 16.3:

- shape: cylindrical;
- material: ferrum-based metal alloy (responsive to permanent magnetic field);
- characteristic structural elements: fragment of external grooving;
- evidence of industrial make;
- damage (traces) typical of the brisant effect of detonated explosive substances;
- present traces of an explosive substance: trotyl (TNT) and hexogen (RDX).

Considering the results obtained, a comparison was made between the characteristics of investigated objects No. 13.2 and 16.3 and those of a reference example from the FEAD FRC collection - a fixing bolt from the cap of SPM limpet mine casing - and its descriptions in reference sources.

As a result of comparison, investigated objects No. 13.2 and 16.3 are established to share identical characteristics with those of a fixing bolt from the cap of SPM limpet mine casing, which sustained the brisant, incendiary, and thermal effects of the explosion, as well as with its description in reference sources.

Similarity was established due to the appearance, geometric shape, structural features, material, size, nature of damage and present traces of an explosive substance based on trotyl (TNT) and hexogen (RDX).

4. Group of investigated objects No. 16.1:

- shape – cylindrical;
- material – ferrum-based metal alloy (responsive to permanent magnetic field);
- characteristic structural elements: external (protruding) and internal (concave) sides, remnants of rivets and corresponding holes

arranged in a certain way, edges retaining a regularly shaped configuration of industrial origin and bits of grey paintwork on the outer surface of some fragments;

- signs of industrial make;
- damage (traces) typical of the brisant and thermal effects of detonated explosive substances;
- present traces of an explosive substance: trotyl (TNT) and hexogen (RDX).

Considering the results obtained, a comparison was made between the characteristics of the group of investigated objects No. 16.1 and those of a reference example from the FEAD FRC collection – a steel plate for the SPM medium limpet mine and its descriptions in reference sources.

As a result of comparison, group of investigated objects No. 16.1 was established to share identical characteristics with those of a steel plate for the SPM medium limpet mine, which sustained the brisant, incendiary and thermal effects of the explosion.

Similarity was established due to the appearance, geometric shape, structural features, material, size, nature of damage and present traces of an explosive substance based on trotyl (TNT) and hexogen (RDX).

5. Group of investigated objects No. 13.3, investigated object No. 16.2:

- shape – irregular, with external (protruding) and internal (concave) sides;
- material – aluminum-based metal alloy;
- characteristic structural elements: parallel transverse grooves (signs of mechanical treatment) about 0.1 mm wide
- damage of thermal origin;
- present traces of an explosive substance: trotyl (TNT) and hexogen (RDX).

Considering the results obtained, a comparison was made between the characteristics of the group of investigated objects No. 13.3, investigated object No. 16.2 and those of a reference example from the FEAD FRC collection – the additional detonator cup of an SPM mine and its descriptions in reference sources.

As a result of comparison, group of investigated objects No. 13.3 and investigated object No. 16.2 are established, probably, to be fragments of an additional detonator cup from the casing of an SPM mine, which were a result of destruction under the brisant, incendiary and thermal effects of the explosion.

6. Group of investigated objects No. 12, investigated objects No. 13.4, 16.5:

- shape – irregular, with external (protruding) and internal (concave) sides;
- material –metal alloy with the properties of a permanent magnet;
- signs of industrial make;
- damage (traces) typical of the brisant and thermal effects of detonated explosive substances;
- damage (traces) typical of mechanical effects (impact, contact);

- present traces of an explosive substance: trotyl (TNT) and hexogen (RDX).

Considering the results obtained, a comparison was made between the characteristics of the group of investigated objects No. 12, investigated objects No. 13.4 and 16.5 and those of a reference example from the FEAD FRC collection – magnets from an SPM mine - and its descriptions in reference sources.

As a result of comparison, group of investigated objects No. 12 and investigated objects No. 13.4 and 16.5 are established, probably, to be magnet fragments from an SPM mine formed as a result of destruction under the brisant, incendiary and thermal effects of the explosion.

7. Group of investigated objects No. 13.5:

- shape – in the form of fragments of a cylindrically coiled spring around 0.1 mm in diameter;
- material – metal;
- signs of industrial make;
- damage (traces) typical of the brisant and thermal effects of detonated explosive substances;
- damage (traces) typical of mechanical effects (impact, contact);
- present traces of an explosive substance: trotyl (TNT) and hexogen (RDX).

Considering the results obtained, a comparison was made between the characteristics of the group of investigated objects No. 13.5 and those of a reference example from the FEAD FRC collection – the spring of a delayed action fuze VZD-1M - and its descriptions in reference sources.

As a result of comparison, group of investigated objects No. 13.5 are established, probably, to be fragments of a spring from the VZD-1M delayed action fuze formed as a result of destruction under the brisant, incendiary and thermal effects of the explosion.

According to reference sources: “an explosive device is a single-use improvised or industrially manufactured device prepared specifically for an explosion intended to injure people or destroy surrounding objects using the fast chemical transformation energy of condensed substances. Explosive devices can be industrially manufactured as well as improvised.

“Explosive devices are known to contain main and auxiliary elements. The main elements are an explosive charge and the means of initiating the explosion. The auxiliary elements are the casing, executive and safety mechanism, ready destructive elements, masking elements, camouflage and fixings.

“Explosive devices and their elements can be made industrially or they can be improvised. An industrially made explosive device is a factory-made explosive device which conforms to normative technical documentation.

An improvised explosive device is an explosive device at least one element of which has been improvised, or which has been assembled or equipped outside the industrial process or in an unregulated manner.” [4.5].

Therefore, having summarized the separate investigations conducted, the following has been established:

1. According to the results of documentary research, an explosive device was detonated on the floor next to the bar on the premises of the Stena bar. The device was equipped with an explosive charge with the power of about 1 - 1.2 kg in TNT equivalent.

2. According to the results of investigation of the explosive substances and products of explosion and gunfire:

- investigated objects No. 2, 8, 9, 10, 12, 13.1, 13.2, 14, 16.1, 16.2, 16.3, 16.4, 16.5, 19, and 22 contain traces of the blast products of explosive substances based on trotyl (TNT) and hexogen (RDX);
- investigated objects No. 3, 7 and 24 contain traces of the blast products of explosive substances based on trotyl (TNT).

The explosive substance detonated may have contained metallic aluminum.

3. The separate and comparative investigations have established that the objects found at the scene of the incident are probably parts of an explosive device, namely:

- fragments of a delayed action VZD-1M fuze;
- casing fragments from an SPM medium limpet mine and fragments of an SPM steel plate.

Having evaluated the summarized results of separate investigations, the following conclusions can be drawn:

1. Around 21:38 on 11.09.2014, an SPM medium limpet mine with a delayed action VZD-1M fuze was detonated at the Stena bar (13 vul. Rymarska, Kharkiv). An SPM mine with a VZD-1M fuze is equipped with an MS brisant explosive charge of normal strength (57% hexogen (RDX), 19% trotyl (TNT), 17% aluminum, 7% phlegmatizer (ceresin)) of 1 kg in mass, which belongs to an industrially made category of ammunition. An SPM mine is an anti-object time-fuse incendiary mine intended for destroying movable and stationary items with metal parts, and can be used on land and under water.
2. A delayed action VZD-1M fuze was used to detonate the SPM mine, which was installed the mine casing, activated with a time delay and working in a standard way.
3. No specialist professional knowledge, education or military mine, explosive or engineering training is required to use an SPM mine with a VZD-1M fuze.

The procedure and rules of operation can be obtained independently from freely available open sources. It should be noted that the period between activating a VZD-1M fuze and the moment of explosion can take from tens of minutes to several days, depending on the number of the metal element (time delay mechanism) and the ambient temperature. Therefore, in breach of the rules for preparing and using this type of mines, it is possible to activate a VZD-1M fuze before the mine is installed on site.

The following reference sources were used during this expert analysis:

1. Order No. 19/1-272n by the State Forensic Research Center of the Ministry of Internal Affairs of Ukraine dated October 31, 2013 “On approving the Instruction on the procedure and documentation of forensic analyses.”
2. Order No. 653 by the Ministry of Internal Affairs of Ukraine dated 07.09.2014 “On approving the instruction on handling explosive materials in the agencies and departments of internal affairs of Ukraine.”
3. V.N. Aginsky, V.I. Golyashin, S.V. Vladimirov. Forensic investigation of explosive substances/ Edited by N.M. Kuzmin, Moscow: All-USSR Research Institute of the Ministry of Internal Affairs of the USSR, 1985, - 72 pages.
4. V.N. Dik. Soviet-made explosive substances, powders and ammunition. In two parts. Part 1, 2. Pictures and illustrations: Reference manual/V.N. Dik – Minsk: “Okhotkontrakt,” 2009 – 240 pages.
5. Yu.M. Dildin, V.V. Martynov et al. “Industrially made explosive devices and their forensic investigation.” Moscow. Expert Forensic Center of the Ministry of Internal Affairs of the Russian Federation. 1991, 120 pages.
6. Yu.M. Dildin, V.V. Martynov et al. “Scene of explosion as an object of forensic investigation.” Moscow. Expert Forensic Center of the Ministry of Internal Affairs of the Russian Federation. 1995, 98 pages.
7. Yu.M. Dildin, V.V. Martynov, A.Yu. Semenov, A.A. Shmyrev. Fundamentals of forensic investigation of improvised explosive devices: Study guide. – M.: All-USSR Forensic Research Center of the USSR Ministry of Internal Affairs, 1991. – 94 pages.
8. “Explosive ammunition.” Book 1. Ministry of Defense of the USSR. M.: 1976, 242 pages.
9. “Explosive ammunition.” Book 2. Ministry of Defense of the USSR, M.: 1976, 184 pages.
10. G.V. Prokhorov-Lukin, V.I. Bykov, V.I. Pashchenko “Methodology for a comprehensive analysis of explosive devices, explosive substances and traces of explosion.” Kyiv, Elite Print, 2011, 216 pages.
11. S.M. Sokolov, Forensic chemical analysis of material evidence. – M.: “Medicine,” 1964. –pp.137-192.
12. V.N. Tsvetkova, L.K. Isayeva “Using thin-layer chromatography and infra-red spectroscopy in investigating certain industrial explosives.” “Expert practice and new investigation methods” journal, issue 9. M.: All-USSR Forensic Research Institute -1975, pp 7 – 16.

The following was used during inspection and investigation: MSP-1 stereomicroscope No. XS 3740, certificate of conformity No. 03/8773; metal gauge GOST 427-75, Vernier caliper ShTs-1 (No. 393935), certificate of conformity No. 03/8745; expert magnifying glass; CAS electronic scales of $\pm 1.0g$ precision (No. 98050605), OLD 41 emitter, samples No. 1-50 of explosive substances from the FEAD FRC collection, a set of chemical reagents, Sorbfil plates for thin-layer chromatography (TU 26-11-17-89). The capture and printing of images was done using digital camera Canon PowerShot A 630, the Intel (R) Celeron (R) PC, CPU 2.8 GHz, 960 GB RPM and laser printer CANON LBP-2900.

The investigated objects have been returned to their original packaging. The necks of packages No. 1 – No. 3, No. 5 – No. 7, No. 10 – No. 25 are tied with white string. The loose ends of the string are attached to a quadrangular piece of white paper folded in half, the label. The openings of packages No. 4, No. 8, and No. 9 are sealed with labels covered with fragments of a clear plastic adhesive tape (scotch tape).

The labels are made in the manner of a form with black print and contain expert signatures in longhand using blue ink as well as a blue round seal of the Forensic Research Center No. 12, Kharkiv Region Main Directorate, Ministry of Internal Affairs of Ukraine:

The content of the labels is as follows:

1) package No. 1

Forensic Research Center, Main Directorate of the Ministry of Internal Affairs of Ukraine in Kharkiv Region			
QF.57-5.8-01.00. 1	Label for object	Version	1
		Page	36 of 1
Object No. 1 Conclusion No. 532/2014 of 04.03.215 Package No. 1 Object description: fragment of fabric (provided by Senior Forensic Investigator, investigations department of the Security Service of Ukraine Kharkiv Regional directorate, Senior Lieutenant of Justice I.M. Babak as part of criminal proceedings No. 22014220000000305) Name of expert: D.A. Karakurkchi Signature (signature) Date: 04.03.2015 (imprint of FEAD FRC seal)			
Danger category: extremely dangerous –dangerous –somewhat dangerous - <u>safe</u> DANGER: EXPLOSIVE			

2) package No. 2

Forensic Research Center, Main Directorate of the Ministry of Internal Affairs of Ukraine in Kharkiv Region			
QF.57-5.8-01.00. 1	Label for object	Version	1
		Page	36 of 1
Object No. 2 Conclusion No. 532/2014 of 04.03.215 Package No. 2 Object description: damaged wallet (provided by Senior Forensic Investigator, investigations department of the Security Service of Ukraine Kharkiv Regional directorate, Senior Lieutenant of Justice I.M. Babak as part of criminal proceedings No. 22014220000000305) Name of expert: D.A. Karakurkchi Signature (signature) Date: 04.03.2015 (imprint of FEAD FRC seal)			
Danger category: extremely dangerous –dangerous –somewhat dangerous - <u>safe</u> DANGER: EXPLOSIVE			

[seal:] Forensic Research Center No. 12 Kharkiv Region
 Main Directorate Ministry of Internal Affairs of Ukraine
 Forensic expert [signature]

D.A. Karakurkchi

3) package No. 3

Forensic Research Center, Main Directorate of the Ministry of Internal Affairs of Ukraine in Kharkiv Region			
QF.57-5.8-01.00. 1	Label for object	Version	1
		Page	37 of 1

Object No. 3
Conclusion No. 532/2014 of 04.03.215
 Package No. 3
 Object description: bank notes (hryvnias) (provided by Senior Forensic Investigator, investigations department of the Security Service of Ukraine Kharkiv Regional directorate, Senior Lieutenant of Justice I.M. Babak as part of criminal proceedings No. 22014220000000305)

Name of expert: D.A. Karakurkchi
 Signature (signature) Date: 04.03.2015
 (imprint of FEAD FRC seal)

Danger category:
~~extremely dangerous~~
~~–dangerous~~
~~–somewhat dangerous~~
 - safe
DANGER: EXPLOSIVE

4) package No. 4

Forensic Research Center, Main Directorate of the Ministry of Internal Affairs of Ukraine in Kharkiv Region			
QF.57-5.8-01.00. 1	Label for object	Version	1
		Page	37 of 1

Object No. 4
Conclusion No. 532/2014 of 04.03.215
 Package No. 4
 Object description: Lenovo laptop (provided by Senior Forensic Investigator, investigations department of the Security Service of Ukraine Kharkiv Regional directorate, Senior Lieutenant of Justice I.M. Babak as part of criminal proceedings No. 22014220000000305)

Name of expert: D.A. Karakurkchi
 Signature (signature) Date: 04.03.2015
 (imprint of FEAD FRC seal)

Danger category:
~~extremely dangerous~~
~~–dangerous~~
~~–somewhat dangerous~~
 - safe
DANGER: EXPLOSIVE

5) package No. 5

Forensic Research Center, Main Directorate of the Ministry of Internal Affairs of Ukraine in Kharkiv Region			
QF.57-5.8-01.00. 1	Label for object	Version	1
		Page	37 of 1

Object No. 5
Conclusion No. 532/2014 of 04.03.215
 Package No. 5
 Object description: four quadrangular emblems and four shield-shaped emblems (provided by Senior Forensic Investigator, investigations department of the Security Service of Ukraine Kharkiv Regional directorate, Senior Lieutenant of Justice I.M. Babak as part of criminal proceedings No. 22014220000000305)

Name of expert: D.A. Karakurkchi
 Signature (signature) Date: 04.03.2015
 (imprint of FEAD FRC seal)

Danger category:
~~extremely dangerous~~
~~–dangerous~~
~~–somewhat dangerous~~
 - safe
DANGER: EXPLOSIVE

6) package No. 6

Forensic Research Center, Main Directorate of the Ministry of Internal Affairs of Ukraine in Kharkiv Region			
QF.57-5.8-01.00. 1	Label for object	Version	1
		Page	37 of 1

Object No. 6
Conclusion No. 532/2014 of 04.03.215
 Package No. 6
 Object description: three laptops and two chargers (provided by Senior Forensic Investigator, investigations department of the Security Service of Ukraine Kharkiv Regional directorate, Senior Lieutenant of Justice I.M. Babak as part of criminal proceedings No. 22014220000000305)

Name of expert: D.A. Karakurkchi
 Signature (signature) Date: 04.03.2015
 (imprint of FEAD FRC seal)

Danger category:
~~extremely dangerous~~
~~–dangerous~~
~~–somewhat dangerous~~
 - safe
DANGER: EXPLOSIVE

[seal:] Forensic Research Center No. 12 Kharkiv Region
 Main Directorate Ministry of Internal Affairs of Ukraine
 Forensic expert [signature]

D.A. Karakurkchi

7) package No. 7

Forensic Research Center, Main Directorate of the Ministry of Internal Affairs of Ukraine in Kharkiv Region			
QF.57-5.8-01.00. 1	Label for object	Version	1
		Page	38 of 1
Object No. 7 Conclusion No. 532/2014 of 04.03.215 Package No. 7 Object description: short blue jacket of manmade material with zip fastening (provided by Senior Forensic Investigator, investigations department of the Security Service of Ukraine Kharkiv Regional directorate, Senior Lieutenant of Justice I.M. Babak as part of criminal proceedings No. 2201422000000305) Name of expert: D.A. Karakurkchi Signature (signature) Date: 04.03.2015 (imprint of FEAD FRC seal)			
Danger category: extremely dangerous –dangerous –somewhat dangerous - <u>safe</u> DANGER: EXPLOSIVE			

8) package No. 8

Forensic Research Center, Main Directorate of the Ministry of Internal Affairs of Ukraine in Kharkiv Region			
QF.57-5.8-01.00. 1	Label for object	Version	1
		Page	38 of 1
Object No. 8 Conclusion No. 532/2014 of 04.03.215 Package No. 8 Object description: fragment of VZD-1M fuze (provided by Senior Forensic Investigator, investigations department of the Security Service of Ukraine Kharkiv Regional directorate, Senior Lieutenant of Justice I.M. Babak as part of criminal proceedings No. 2201422000000305) Name of expert: D.A. Karakurkchi Signature (signature) Date: 04.03.2015 (imprint of FEAD FRC seal)			
Danger category: extremely dangerous –dangerous –somewhat dangerous - <u>safe</u> DANGER: EXPLOSIVE			

9) package No. 9

Forensic Research Center, Main Directorate of the Ministry of Internal Affairs of Ukraine in Kharkiv Region			
QF.57-5.8-01.00. 1	Label for object	Version	1
		Page	38 of 1
Object No. 9 Conclusion No. 532/2014 of 04.03.215 Package No. 9 Object description: metal fragment (provided by Senior Forensic Investigator, investigations department of the Security Service of Ukraine Kharkiv Regional directorate, Senior Lieutenant of Justice I.M. Babak as part of criminal proceedings No. 2201422000000305) Name of expert: D.A. Karakurkchi Signature (signature) Date: 04.03.2015 (imprint of FEAD FRC seal)			
Danger category: extremely dangerous –dangerous –somewhat dangerous - <u>safe</u> DANGER: EXPLOSIVE			

10) package No. 10

Forensic Research Center, Main Directorate of the Ministry of Internal Affairs of Ukraine in Kharkiv Region			
QF.57-5.8-01.00. 1	Label for object	Version	1
		Page	38 of 1
Object No. 10 Conclusion No. 532/2014 of 04.03.215 Package No. 10 Object description: gauze pad (provided by Senior Forensic Investigator, investigations department of the Security Service of Ukraine Kharkiv Regional directorate, Senior Lieutenant of Justice I.M. Babak as part of criminal proceedings No. 2201422000000305) Name of expert: D.A. Karakurkchi Signature (signature) Date: 04.03.2015 (imprint of FEAD FRC seal)			
Danger category: extremely dangerous –dangerous –somewhat dangerous - <u>safe</u> DANGER: EXPLOSIVE			

[seal:] Forensic Research Center No. 12 Kharkiv Region
 Main Directorate Ministry of Internal Affairs of Ukraine
 Forensic expert [signature]

D.A. Karakurkchi

11) package No. 11

Forensic Research Center, Main Directorate of the Ministry of Internal Affairs of Ukraine in Kharkiv Region			
QF.57-5.8-01.00. 1	Label for object	Version	1
		Page	39 of 1
Object No. 11 Conclusion No. 532/2014 of 04.03.215 Package No. 11 Object description: fragment of white-and-green fabric with pocket (provided by Senior Forensic Investigator, investigations department of the Security Service of Ukraine Kharkiv Regional directorate, Senior Lieutenant of Justice I.M. Babak as part of criminal proceedings No. 2201422000000305) Name of expert: D.A. Karakurkchi Signature (signature) Date: 04.03.2015 (imprint of FEAD FRC seal)			
Danger category: extremely dangerous -dangerous -somewhat dangerous - safe DANGER: EXPLOSIVE			

12) package No. 12

Forensic Research Center, Main Directorate of the Ministry of Internal Affairs of Ukraine in Kharkiv Region			
QF.57-5.8-01.00. 1	Label for object	Version	1
		Page	39 of 1
Object No. 12 Conclusion No. 532/2014 of 04.03.215 Package No. 12 Object description: magnet fragments(provided by Senior Forensic Investigator, investigations department of the Security Service of Ukraine Kharkiv Regional directorate, Senior Lieutenant of Justice I.M. Babak as part of criminal proceedings No. 2201422000000305) Name of expert: D.A. Karakurkchi Signature (signature) Date: 04.03.2015 (imprint of FEAD FRC seal)			
Danger category: extremely dangerous -dangerous -somewhat dangerous - safe DANGER: EXPLOSIVE			

13) package No. 13

Forensic Research Center, Main Directorate of the Ministry of Internal Affairs of Ukraine in Kharkiv Region			
QF.57-5.8-01.00. 1	Label for object	Version	1
		Page	39 of 1
Object No. 13 Conclusion No. 532/2014 of 04.03.215 Package No. 13 Object description: fragments of a fuze spring, fuze attachment cup, additional detonator cup, bolt and magnet (from SPM mine casing) (provided by Senior Forensic Investigator, investigations department of the Security Service of Ukraine Kharkiv Regional directorate, Senior Lieutenant of Justice I.M. Babak as part of criminal proceedings No. 2201422000000305) Name of expert: D.A. Karakurkchi Signature (signature) Date: 04.03.2015 (imprint of FEAD FRC seal)			
Danger category: extremely dangerous -dangerous -somewhat dangerous - safe DANGER: EXPLOSIVE			

14) package 14

Forensic Research Center, Main Directorate of the Ministry of Internal Affairs of Ukraine in Kharkiv Region			
QF.57-5.8-01.00. 1	Label for object	Version	1
		Page	39 of 1
Object No. 14 Conclusion No. 532/2014 of 04.03.215 Package No. 14 Object description: bits of torn fabric (provided by Senior Forensic Investigator, investigations department of the Security Service of Ukraine Kharkiv Regional directorate, Senior Lieutenant of Justice I.M. Babak as part of criminal proceedings No. 2201422000000305) Name of expert: D.A. Karakurkchi Signature (signature) Date: 04.03.2015 (imprint of FEAD FRC seal)			
Danger category: extremely dangerous -dangerous -somewhat dangerous - safe DANGER: EXPLOSIVE			

[seal:] Forensic Research Center No. 12 Kharkiv Region
 Main Directorate Ministry of Internal Affairs of Ukraine
 Forensic expert [signature]

D.A. Karakurkchi

15) package No. 15

Forensic Research Center, Main Directorate of the Ministry of Internal Affairs of Ukraine in Kharkiv Region			
QF.57-5.8-01.00. 1	Label for object	Version	1
		Page	40 of 1

Object No. 15
Conclusion No. 532/2014 of 04.03.215
 Package No. 15
 Object description: metal plate (provided by Senior Forensic Investigator, investigations department of the Security Service of Ukraine Kharkiv Regional directorate, Senior Lieutenant of Justice I.M. Babak as part of criminal proceedings No. 2201422000000305)

Name of expert: D.A. Karakurkchi
 Signature (signature) Date: 04.03.2015
 (imprint of FEAD FRC seal)

Danger category:
~~extremely dangerous~~
~~–dangerous~~
~~–somewhat dangerous~~
 - safe
DANGER: EXPLOSIVE

16) package 16

Forensic Research Center, Main Directorate of the Ministry of Internal Affairs of Ukraine in Kharkiv Region			
QF.57-5.8-01.00. 1	Label for object	Version	1
		Page	40 of 1

Object No. 16
Conclusion No. 532/2014 of 04.03.215
 Package No. 16
 Object description: fragments of an SPM steel plate, bolt, additional detonator cup and magnet, bits of torn fabric (provided by Senior Forensic Investigator, investigations department of the Security Service of Ukraine Kharkiv Regional directorate, Senior Lieutenant of Justice I.M. Babak as part of criminal proceedings No. 2201422000000305)

Name of expert: D.A. Karakurkchi
 Signature (signature) Date: 04.03.2015
 (imprint of FEAD FRC seal)

Danger category:
~~extremely dangerous~~
~~–dangerous~~
~~–somewhat dangerous~~
 - safe
DANGER: EXPLOSIVE

17) package No. 17

Forensic Research Center, Main Directorate of the Ministry of Internal Affairs of Ukraine in Kharkiv Region			
QF.57-5.8-01.00. 1	Label for object	Version	1
		Page	40 of 1

Object No. 17
Conclusion No. 532/2014 of 04.03.215
 Package No. 17
 Object description: red-and-black flag (provided by Senior Forensic Investigator, investigations department of the Security Service of Ukraine Kharkiv Regional directorate, Senior Lieutenant of Justice I.M. Babak as part of criminal proceedings No. 2201422000000305)

Name of expert: D.A. Karakurkchi
 Signature (signature) Date: 04.03.2015
 (imprint of FEAD FRC seal)

Danger category:
~~extremely dangerous~~
~~–dangerous~~
~~–somewhat dangerous~~
 - safe
DANGER: EXPLOSIVE

18) package No. 18

Forensic Research Center, Main Directorate of the Ministry of Internal Affairs of Ukraine in Kharkiv Region			
QF.57-5.8-01.00. 1	Label for object	Version	1
		Page	40 of 1

Object No. 18
Conclusion No. 532/2014 of 04.03.215
 Package No. 18
 Object description: scarf and man's tracksuit top (provided by Senior Forensic Investigator, investigations department of the Security Service of Ukraine Kharkiv Regional directorate, Senior Lieutenant of Justice I.M. Babak as part of criminal proceedings No. 2201422000000305)

Name of expert: D.A. Karakurkchi
 Signature (signature) Date: 04.03.2015
 (imprint of FEAD FRC seal)

Danger category:
~~extremely dangerous~~
~~–dangerous~~
~~–somewhat dangerous~~
 - safe
DANGER: EXPLOSIVE

[seal:] Forensic Research Center No. 12 Kharkiv Region
 Main Directorate Ministry of Internal Affairs of Ukraine
 Forensic expert [signature]

D.A. Karakurkchi

19) package No. 19

Forensic Research Center, Main Directorate of the Ministry of Internal Affairs of Ukraine in Kharkiv Region			
QF.57-5.8-01.00. 1	Label for object	Version Page	1 41 of 1

Object No. 19
Conclusion No. 532/2014 of 04.03.215
 Package No. 19
 Object description: pair of ladies' black ankle boots (provided by Senior Forensic Investigator, investigations department of the Security Service of Ukraine Kharkiv Regional directorate, Senior Lieutenant of Justice I.M. Babak as part of criminal proceedings No. 22014220000000305)

Name of expert: D.A. Karakurkchi
 Signature (signature) Date: 04.03.2015
 (imprint of FEAD FRC seal)

Danger category:
~~extremely dangerous~~
~~–dangerous~~
~~–somewhat dangerous~~
 - safe
~~DANGER: EXPLOSIVE~~

20) package No. 20

Forensic Research Center, Main Directorate of the Ministry of Internal Affairs of Ukraine in Kharkiv Region			
QF.57-5.8-01.00. 1	Label for object	Version Page	1 41 of 1

Object No. 20
Conclusion No. 532/2014 of 04.03.215
 Package No. 20
 Object description: ladies' black knit jumper (provided by Senior Forensic Investigator, investigations department of the Security Service of Ukraine Kharkiv Regional directorate, Senior Lieutenant of Justice I.M. Babak as part of criminal proceedings No. 22014220000000305)

Name of expert: D.A. Karakurkchi
 Signature (signature) Date: 04.03.2015
 (imprint of FEAD FRC seal)

Danger category:
~~extremely dangerous~~
~~–dangerous~~
~~–somewhat dangerous~~
 - safe
~~DANGER: EXPLOSIVE~~

21) package No. 21

Forensic Research Center, Main Directorate of the Ministry of Internal Affairs of Ukraine in Kharkiv Region			
QF.57-5.8-01.00. 1	Label for object	Version Page	1 41 of 1

Object No. 21
Conclusion No. 532/2014 of 04.03.215
 Package No. 21
 Object description: black-and-brown ladies' handbag (provided by Senior Forensic Investigator, investigations department of the Security Service of Ukraine Kharkiv Regional directorate, Senior Lieutenant of Justice I.M. Babak as part of criminal proceedings No. 22014220000000305)

Name of expert: D.A. Karakurkchi
 Signature (signature) Date: 04.03.2015
 (imprint of FEAD FRC seal)

Danger category:
~~extremely dangerous~~
~~–dangerous~~
~~–somewhat dangerous~~
 - safe
~~DANGER: EXPLOSIVE~~

22) package No. 22

Forensic Research Center, Main Directorate of the Ministry of Internal Affairs of Ukraine in Kharkiv Region			
QF.57-5.8-01.00. 1	Label for object	Version Page	1 41 of 1

Object No. 22
Conclusion No. 532/2014 of 04.03.215
 Package No. 22
 Object description: white plastic bag with man's shoes, socks and belt (provided by Senior Forensic Investigator, investigations department of the Security Service of Ukraine Kharkiv Regional directorate, Senior Lieutenant of Justice I.M. Babak as part of criminal proceedings No. 22014220000000305)

Name of expert: D.A. Karakurkchi
 Signature (signature) Date: 04.03.2015
 (imprint of FEAD FRC seal)

Danger category:
~~extremely dangerous~~
~~–dangerous~~
~~–somewhat dangerous~~
 - safe
~~DANGER: EXPLOSIVE~~

[seal:] Forensic Research Center No. 12 Kharkiv Region
 Main Directorate Ministry of Internal Affairs of Ukraine
 Forensic expert [signature]

D.A. Karakurkchi

23) package No. 23

Forensic Research Center, Main Directorate of the Ministry of Internal Affairs of Ukraine in Kharkiv Region			
QF.57-5.8-01.00. 1	Label for object	Version	1
		Page	42 of 1
Object No. 23 Conclusion No. 532/2014 of 04.03.215 Package No. 23 Object description: pair of blue jeans (provided by Senior Forensic Investigator, investigations department of the Security Service of Ukraine Kharkiv Regional directorate, Senior Lieutenant of Justice I.M. Babak as part of criminal proceedings No. 22014220000000305) Name of expert: D.A. Karakurkchi Signature (signature) Date: 04.03.2015 (imprint of FEAD FRC seal)			
<u>Danger category:</u> extremely dangerous –dangerous –somewhat dangerous - <u>safe</u> DANGER: EXPLOSIVE			

24) package No. 24

Forensic Research Center, Main Directorate of the Ministry of Internal Affairs of Ukraine in Kharkiv Region			
QF.57-5.8-01.00. 1	Label for object	Version	1
		Page	42 of 1
Object No. 24 Conclusion No. 532/2014 of 04.03.215 Package No. 24 Object description: pair of blue jeans, white short-sleeve T-shirt and grey jumper (provided by Senior Forensic Investigator, investigations department of the Security Service of Ukraine Kharkiv Regional directorate, Senior Lieutenant of Justice I.M. Babak as part of criminal proceedings No. 22014220000000305) Name of expert: D.A. Karakurkchi Signature (signature) Date: 04.03.2015 (imprint of FEAD FRC seal)			
<u>Danger category:</u> extremely dangerous –dangerous –somewhat dangerous - <u>safe</u> DANGER: EXPLOSIVE			

25) package No. 25

Forensic Research Center, Main Directorate of the Ministry of Internal Affairs of Ukraine in Kharkiv Region			
QF.57-5.8-01.00. 1	Label for object	Version	1
		Page	42 of 1
Object No. 25 Conclusion No. 532/2014 of 04.03.215 Package No. 25 Object description: gauze pad (provided by Senior Forensic Investigator, investigations department of the Security Service of Ukraine Kharkiv Regional directorate, Senior Lieutenant of Justice I.M. Babak as part of criminal proceedings No. 22014220000000305) Name of expert: D.A. Karakurkchi Signature (signature) Date: 04.03.2015 (imprint of FEAD FRC seal)			
<u>Danger category:</u> extremely dangerous –dangerous –somewhat dangerous - <u>safe</u> DANGER: EXPLOSIVE			

The expert conclusion is appended by an illustrative table, an expenses report and twenty-five packages containing investigated objects.

CONCLUSIONS

1. The objects retrieved during an inspection of the incident scene and submitted for investigation bear traces of blast products of the following explosive substances:

- based on trotyl (TNT) and hexogen (RDX) (investigated objects No. 2, 8, 9, 10, 12, 13.1, 13.2, 14, 16.1, 16.2, 16.3, 16.4, 16.5, 19, 22, and 25);
- based on trotyl (TNT) (investigated objects No. 3, 7, and 24).

[seal:] Forensic Research Center No. 12 Kharkiv Region
 Main Directorate Ministry of Internal Affairs of Ukraine
 Forensic expert [signature]

D.A. Karakurkchi

The explosive substance detonated may have contained metallic aluminum.

2. Around 21.38 on 11.09.2014, an SPM medium limpet mine with a delayed action VZD-1M fuze was detonated at the Stena bar (13 vul. Rymarska, Kharkiv). An SPM mine with a VZD-1M fuze is equipped with an MS brisant explosive charge of normal strength (57% hexogen (RDX), 19% trotyl (TNT), 17% aluminum, 7% phlegmatizer (ceresin)) of 1 kg in mass, which belongs to an industrially made category of ammunition. An SPM mine is an anti-object time-fuse incendiary mine intended for destroying movable and stationary items with metal parts and can be used on land and under water.
3. A delayed action VZD-1M fuze was used to detonate the SPM mine, which was installed the mine casing, activated with a time delay and working in a standard way.
4. No. specialist professional knowledge, education or military mine, explosive or engineering training is required to use an SPM mine with a VZD-1M fuze. The procedure and rules of operation can be obtained independently from freely available open sources. It should be noted that the period between activating a VZD-1M fuze and the moment of explosion can take from tens of minutes to several days, depending on the number of the metal element (time delay mechanism) and the ambient temperature. Therefore, in breach of the rules for preparing and using this type of mines, it is possible to activate a VZD-1M fuze before the mine is installed on site.

ILLUSTRATIVE TABLE

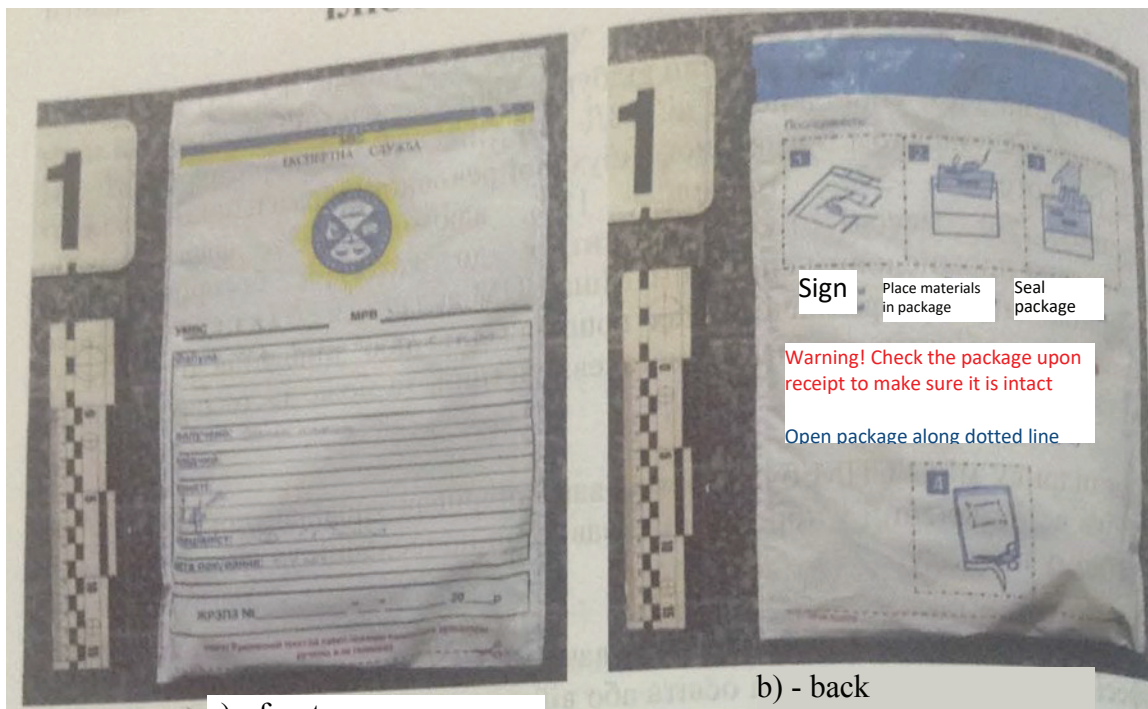

a) - front

b) - back

Figure 1 – View of package No. 1 (bag No. 1784474)



a) - front

b) - back

Figure 2 – View of package No. 2 (bag No. 1784474)



Figure 3 – View of package No. 3 (bag No. 0508138)

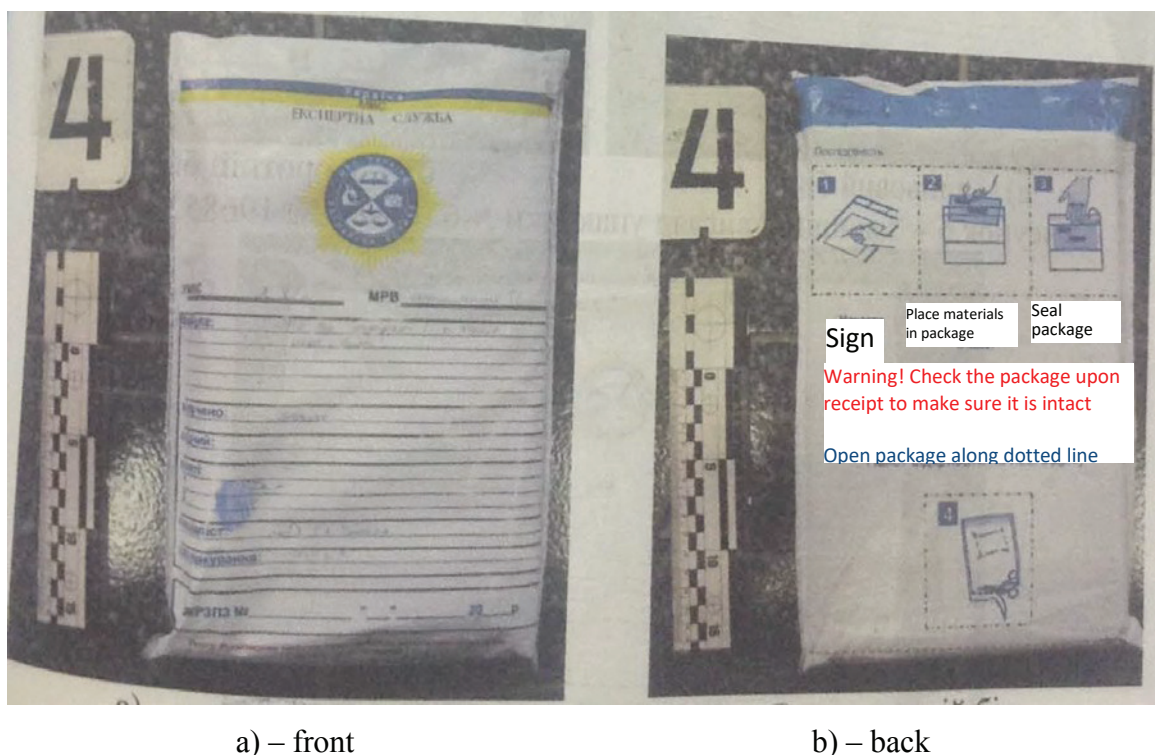

Figure 4 – View of package No. 4 (bag No. 1784473)

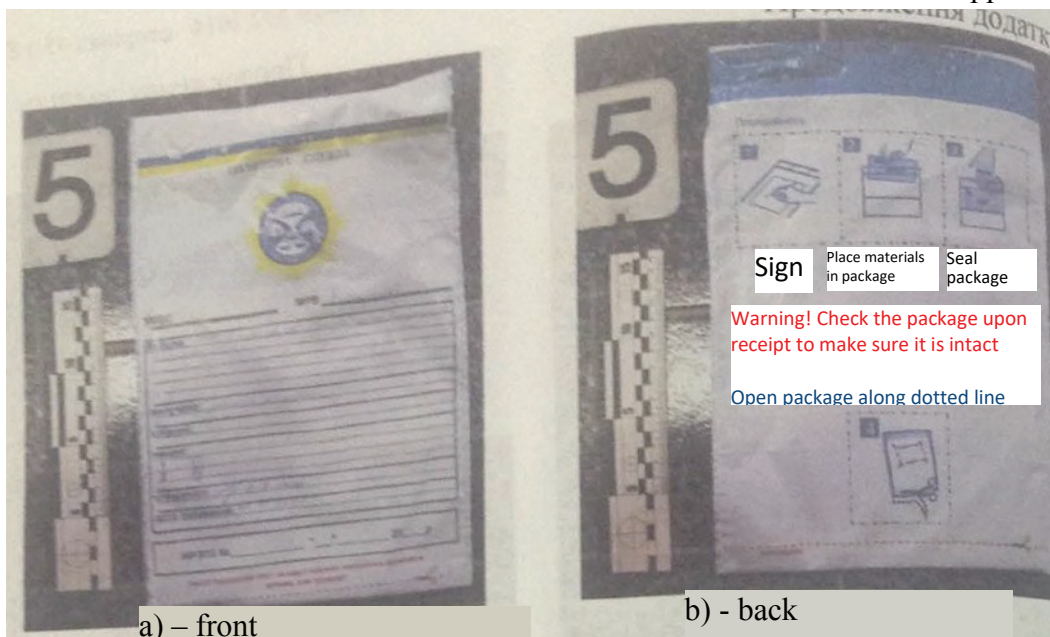
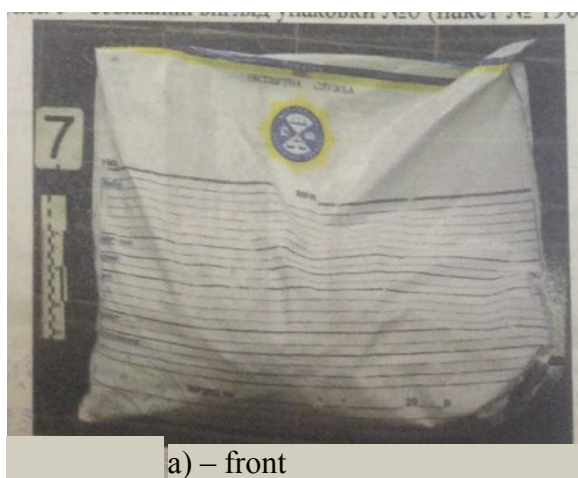
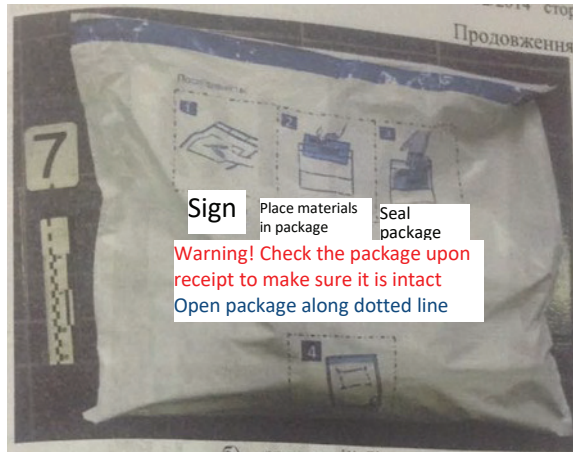

Figure 5 – View of package No. 5 (bag No. 1784476)



Figure 6 – View of package No. 6 (bag No. 1968523)





b) – back

Figure 7 – View of package No. 7 (bag No. 1968085)

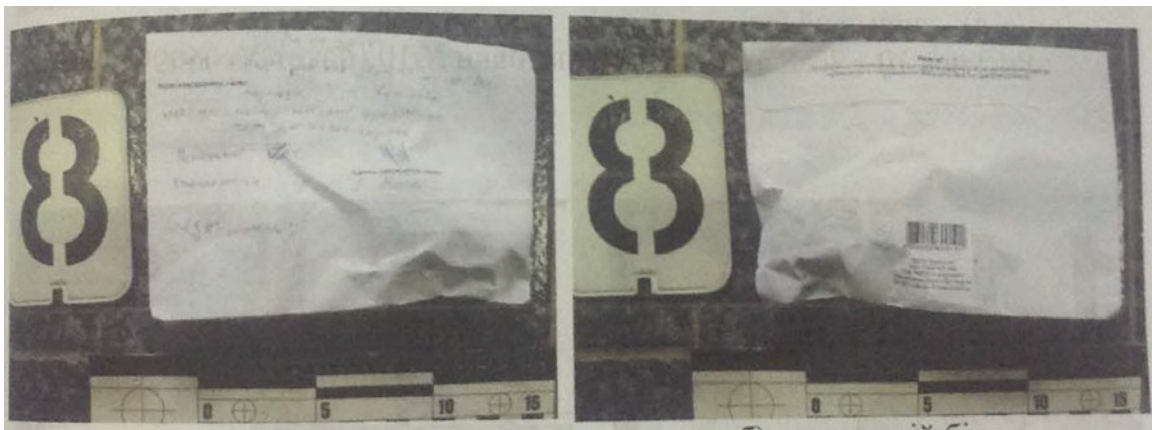

a) – front

b) – back

Figure 8 – View of package No. 8



a) – front

b) - back

Figure 9 – View of package No. 9 (bag No. 1784476)



a) – front

b) - back

Figure 10 – View of package No. 10 (bag No. 0509977)



a) – front

b) – back

Figure 11 – View of package No. 11 (bag No. 0509968)



Figure 12 – View of package No. 12 (bag No. 0509969)



Figure 13 – View of package No. 13 (bag No. 0509979)



Figure 14 – View of package No. 14 (bag No. 1158952)



Figure 15 – View of package No. 15 (bag No. 1158955)



a) – front

a) – front

b) – back

Figure 16 – View of package No. 16 (bag No. 1158953)



a) – front

b) – back

Figure 17 – View of package No. 17 (bag No. 0508137)



Figure 18 – View of package No. 18 (bag No. 1784476)



Figure 19 – View of package No. 19 (bag No. 1784476)



Figure 20 – View of package No. 20 (bag No. 1784476)



Figure 21 – View of package No. 21 (bag No. 1784476)



Figure 22 – View of package No. 22 (bag No. 1784476)



Figure 23 – View of package No. 23 (bag No. 1784476)



Figure 24 – View of package No. 24 (bag No. 1784476)



Figure 25 – View of package No. 25 (bag No. 1784476)



a) – front

b) – back

Figure 26 – View of the fabric fragment retrieved from package No. 1:
investigated object No. 1



a) – front

b) - back

Figure 27 – View of the wallet retrieved from package No. 2:
investigated object No. 2



Figure 28 – View of investigated object No. 2 as opened



Figure 29 – View of cards and money retrieved from investigated object No. 2



Figure 30 – View of PrivatBank cards retrieved from investigated object No. 2 (front)

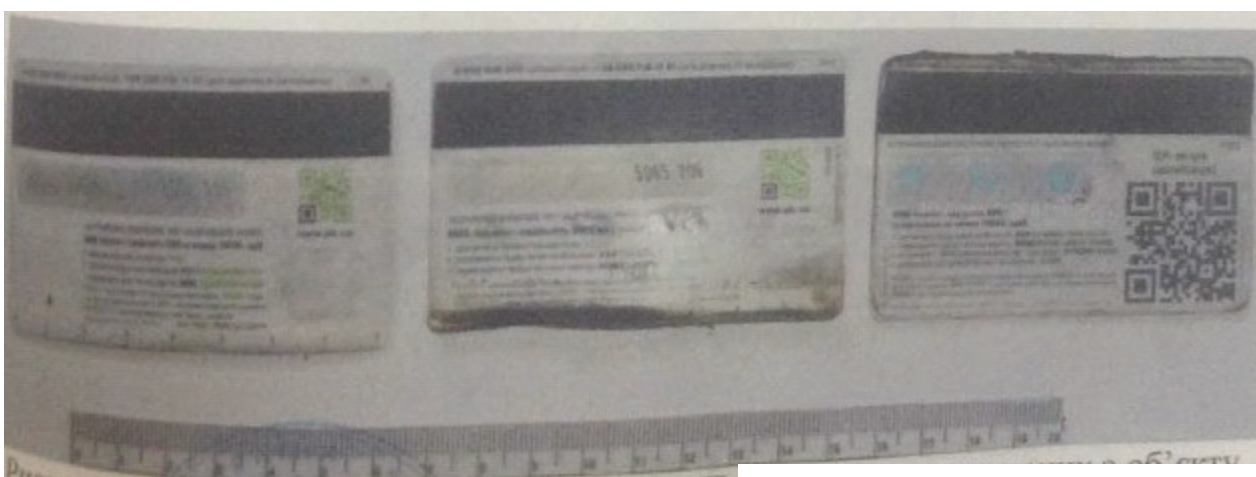

Figure 31 – View of PrivatBank cards retrieved from investigated object No. 2 (back)

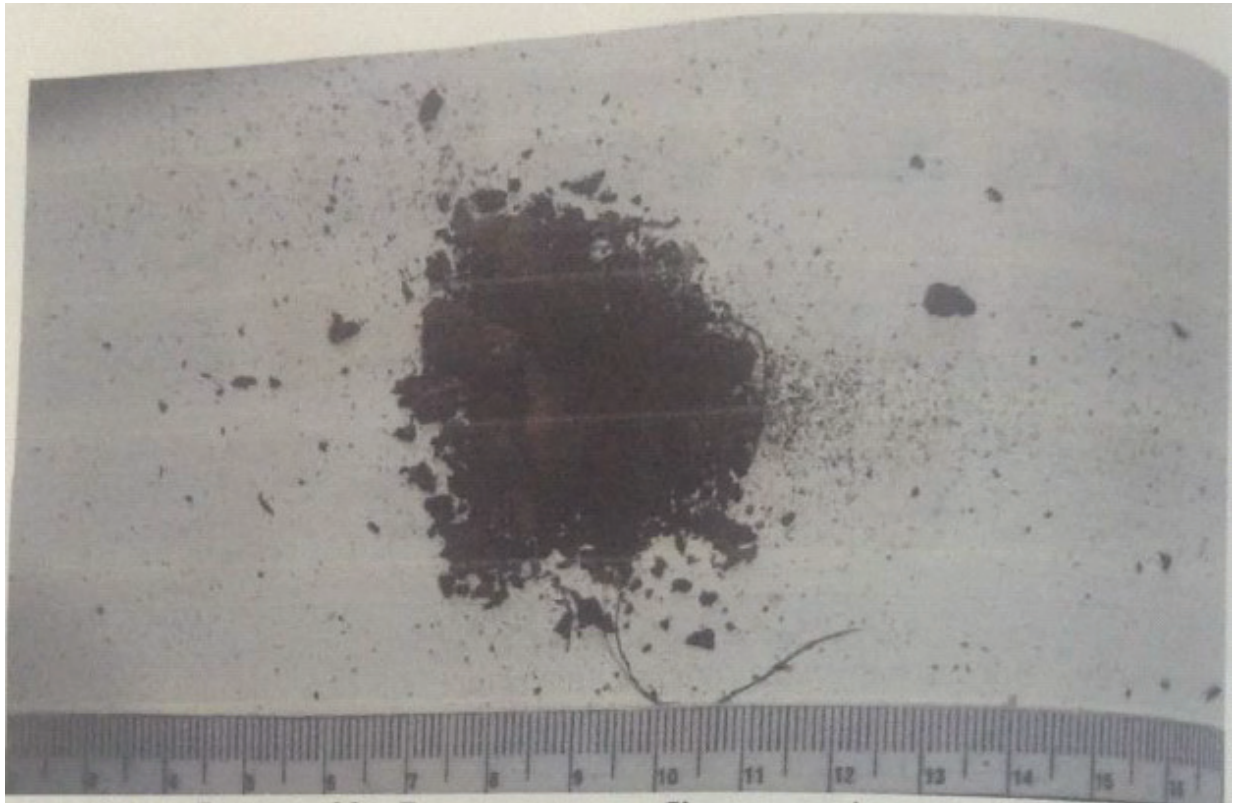

Figure 32 – View of debris from investigated object No. 2



Figure 33 – View of bank notes retrieved from package No. 3:
group of investigated objects No. 3



a) – front

b) – back

Figure 34 – View of Lenovo laptop retrieved from package No. 4:
investigated object No. 4



Figure 35 – View of Lenovo laptop retrieved from package No. 4 as opened - investigated object No. 4



Figure 36 – View of emblems retrieved from package No. 5 -
group of investigated objects No. 5



Figure 37 – View of eMachines laptop with charger retrieved from package No. 6
(view of top cover)



Figure 38 – View of eMachines laptop with charger retrieved from package No. 6
(view of bottom cover)

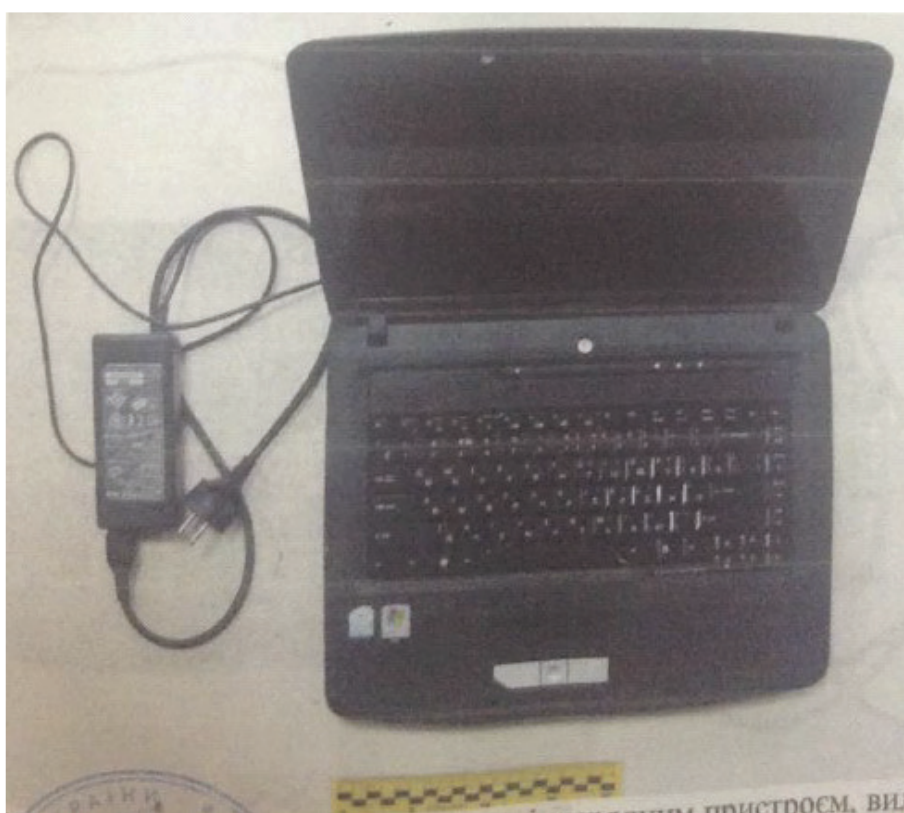

Figure 39 – View of eMachines laptop with charger retrieved from package No. 6
(as opened)

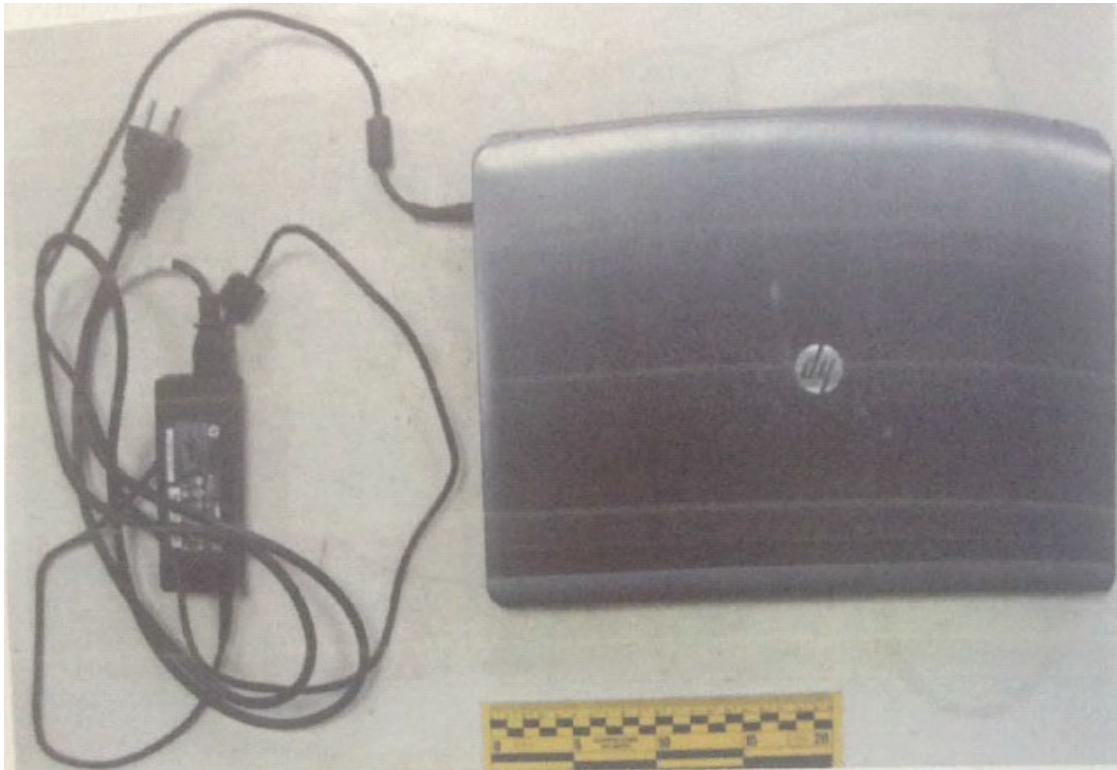

Figure 40 – View of HP laptop with charger retrieved from package No. 6
(view of top cover)

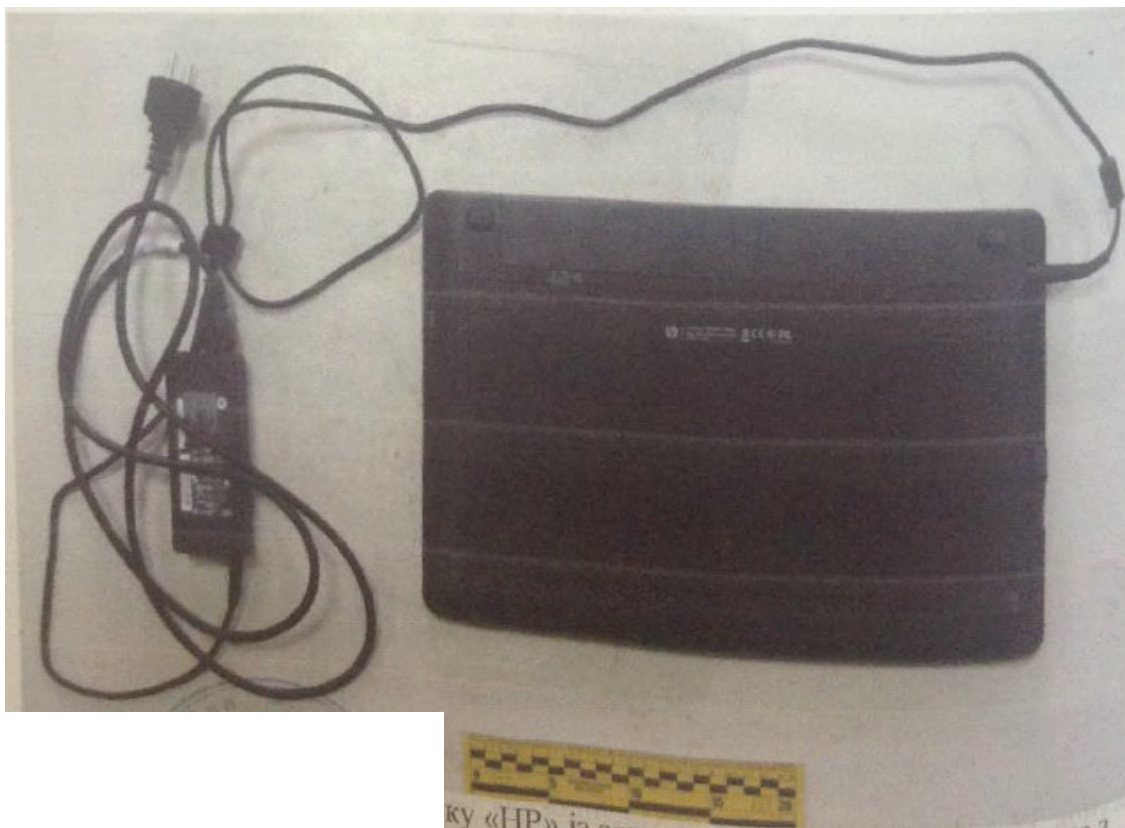

Figure 41 – View of HP laptop with charger retrieved from package No. 6
(view of bottom cover)



Figure 42 – View of HP laptop with charger retrieved from package No. 6
(as opened)



Figure 43 – View of HP laptop without charger retrieved from package No. 6
(view of top cover)



Figure 44 – View of HP laptop without charger retrieved from package No. 6
(view of bottom cover)



Figure 45 – View of HP laptop without charger retrieved from package No. 6
(as opened)

[seal:] Forensic Research Center No. 12 Kharkiv Region
Main Directorate Ministry of Internal Affairs of Ukraine
Forensic expert [signature]

D.A. Karakurkchi



a) – front

b) – back

Figure 46 – View of jacket retrieved from package No. 7 - investigated object No. 7

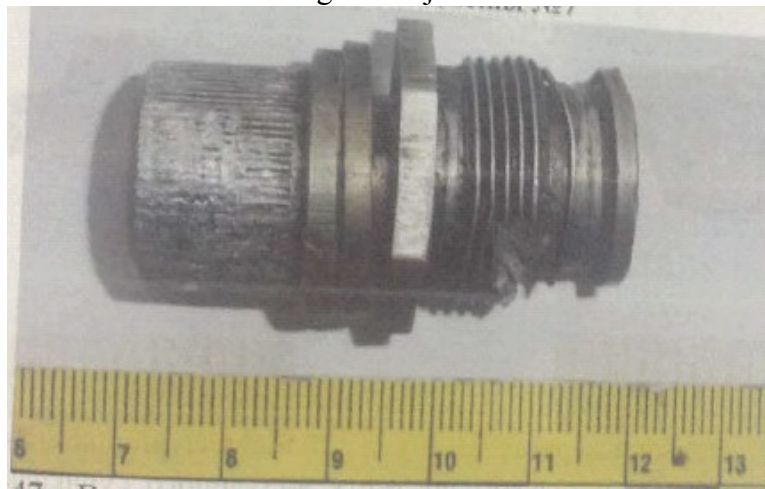

Figure 47 – View of metal object retrieved from package No. 8 - investigated object No. 8



Figure 48 – View of investigated object No. 8 taken apart



a) view of cap

b) view of crossed sections to fit the metal element and cutter

c) view of bottom side with remnants of firing pin and metal element

Figure 49 – View of characteristic features of investigated object No. 8 when taken apart

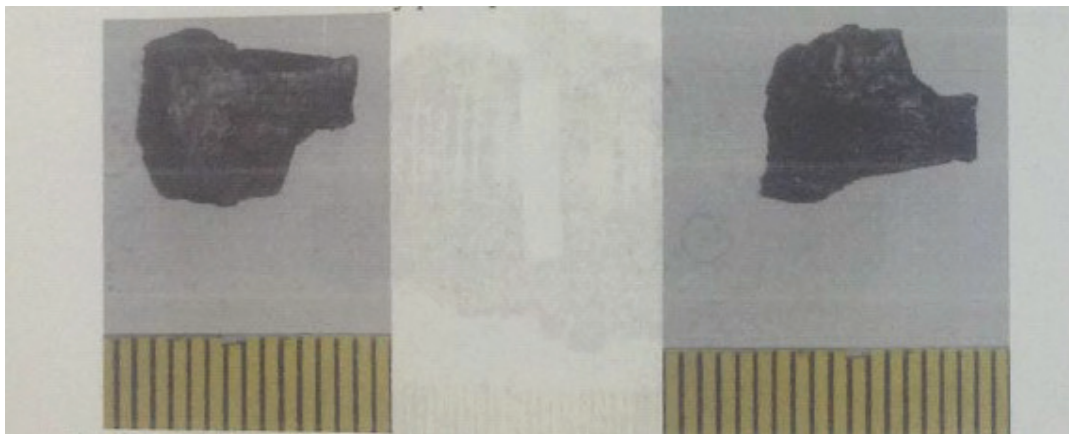

a) view of outer surface

b) view of inner surface

Figure 50 – View of metal item retrieved from package No. 9 investigated object No. 9



Figure 51 – View of gauze pad retrieved from package No. 10 investigated object No. 10



a) front



b) back

Figure 52 – View of fabric fragment retrieved from package No. 11
investigated object No. 11

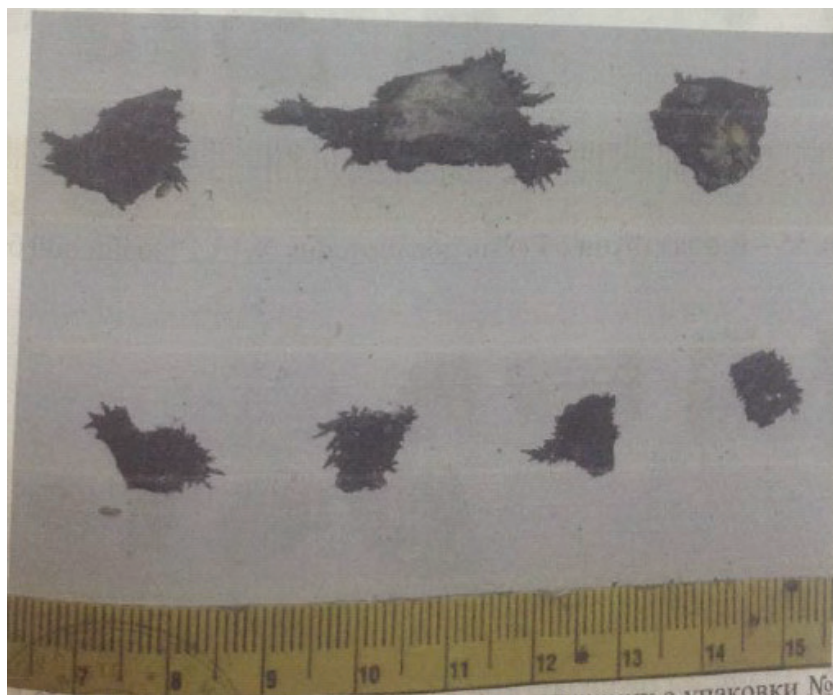

Figure 53 – View of metal fragments retrieved from package No. 12
group of investigated objects No. 12



Figure 54 – View of metal fragments retrieved from package No. 13

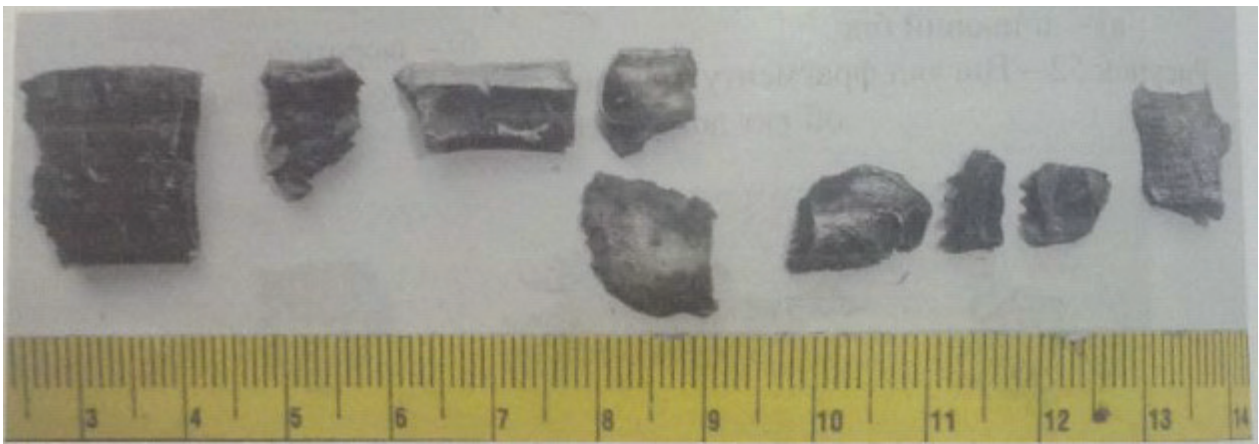

Figure 55 – View of group of investigated objects No. 13.1 (outer surface)



Figure 56 – View of group of investigated objects No. 13.1 (inner surface)



Figure 57 – View of two metal fragments with characteristic structural features from group of investigated objects No. 13.1 (close-up)



Figure 58 – View of investigated object No. 13.2

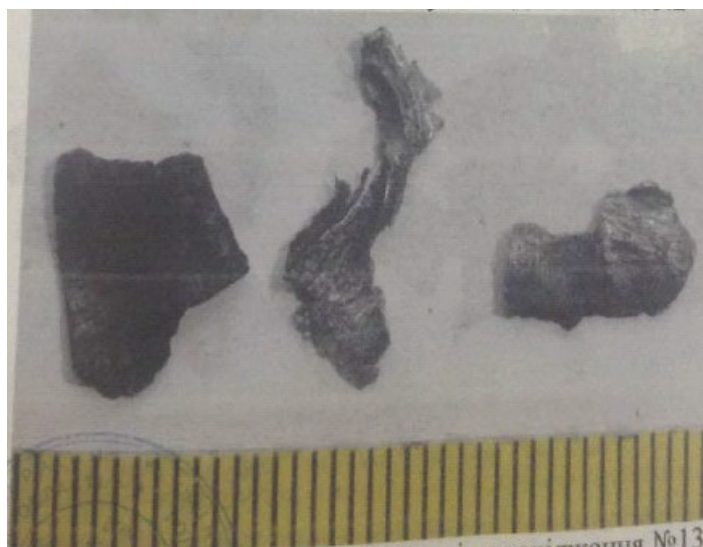

Figure 59 – View of group of investigated objects No. 13.3



Figure 60 – View of investigated object No. 13.4



Figure 61 – View of group of investigated objects No. 13.5

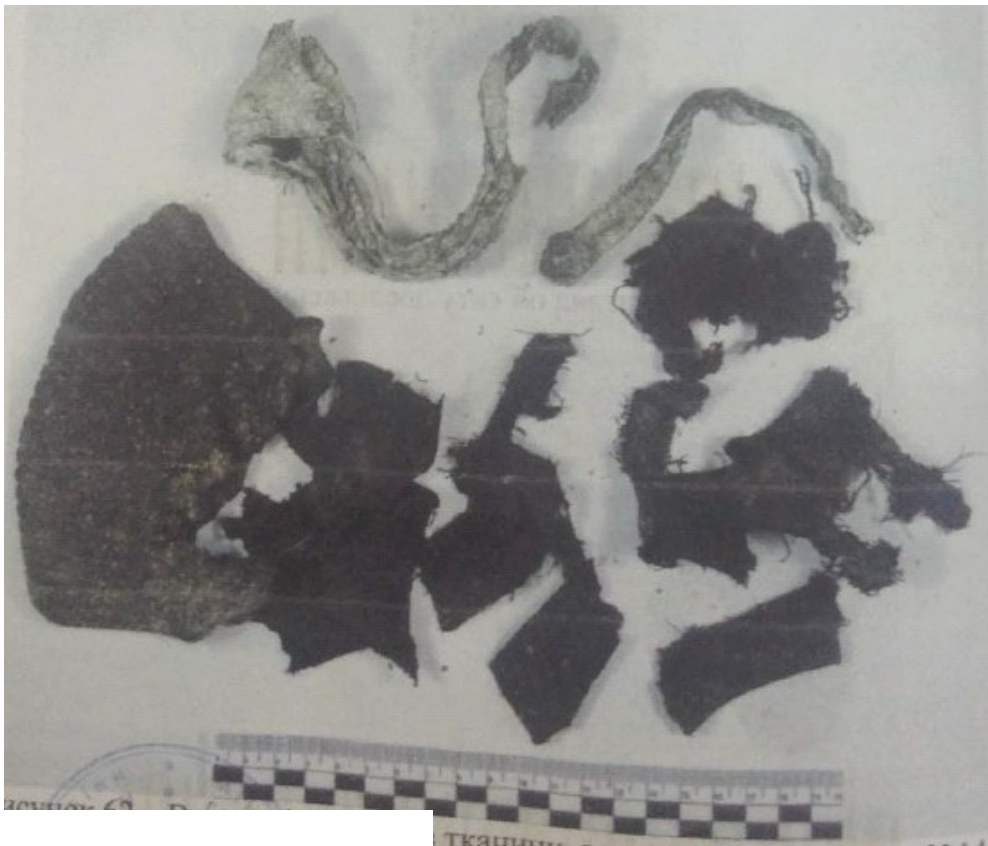

Figure 62 – View of fabric fragments retrieved from package No. 14 –
investigated object No. 14

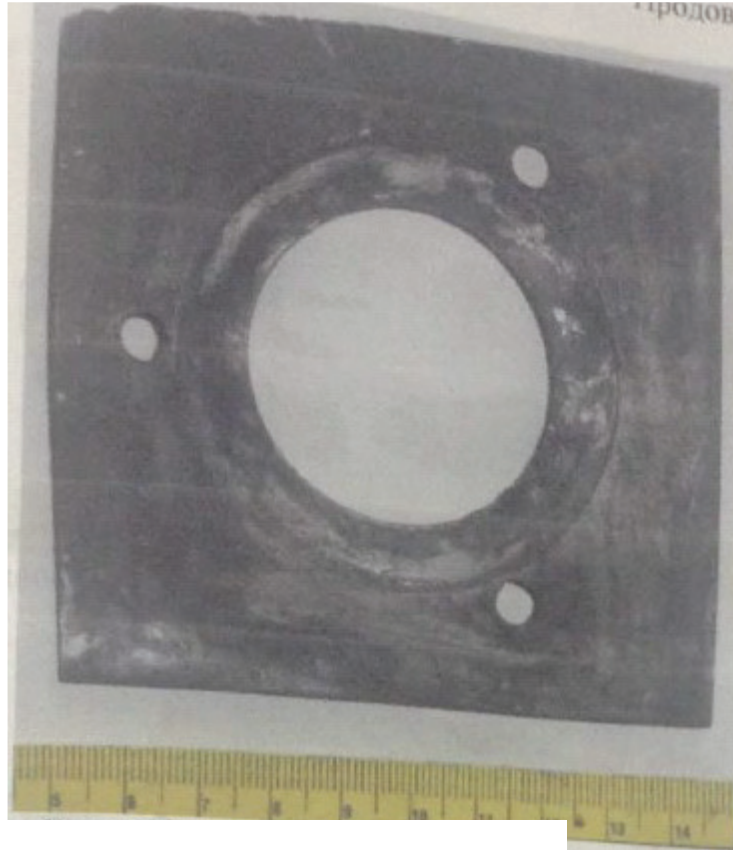

Figure 63 – View of metal fragment retrieved from package No. 15 –
investigated object No. 15



Figure 64 – View of metal fragments retrieved from package No. 16



Figure 65 – View of group of investigated objects No. 16.1 (outer surface)



Figure 66 – View of group of investigated objects No. 16.1 (inner surface)

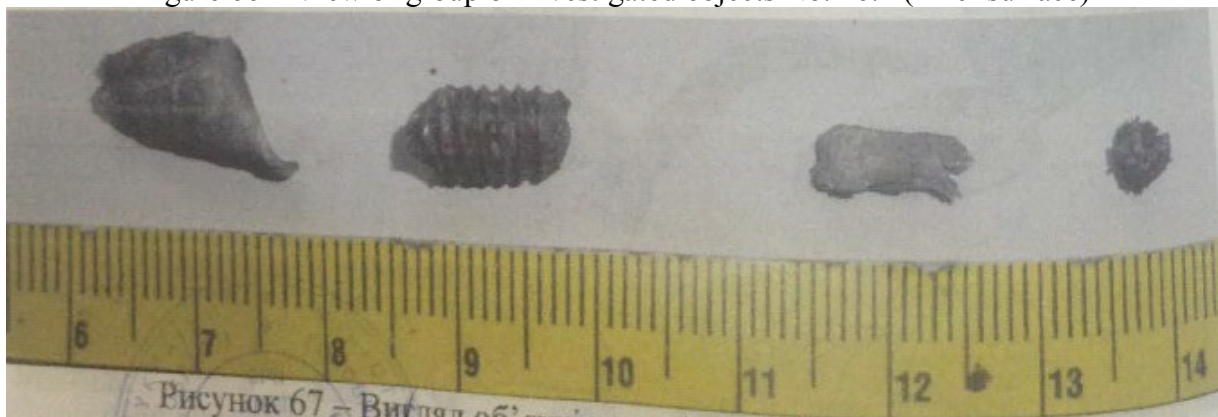

Figure 67 – View of investigated objects No. 16.2 – 16.5 (from left)

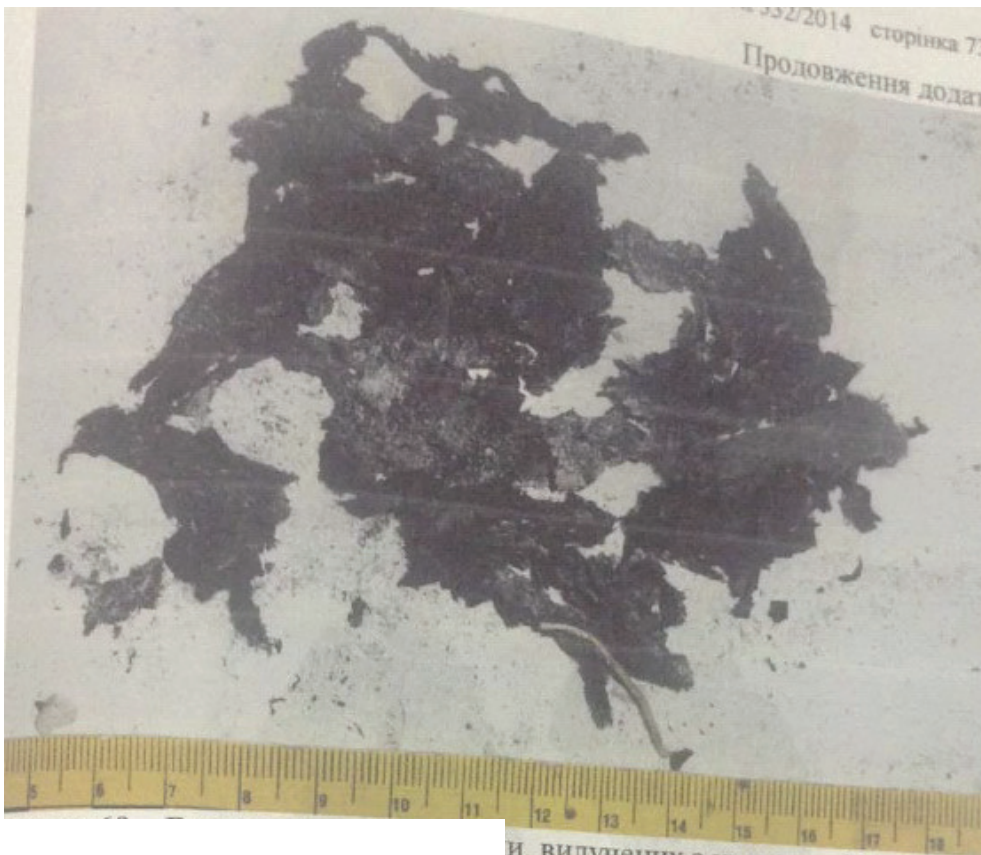

Figure 68 – View of torn fabric fragments retrieved from package No. 16 – group of investigated objects No. 16.6



Figure 69 – View of fabric fragment retrieved from package No. 17 – investigated object No. 17



Figure 70 – View of clothes retrieved from package No. 18 –
group of investigated objects No. 18



Figure 71 – View of shoes retrieved from package No. 19 –
group of investigated objects No. 19



Figure 72 – View of clothes retrieved from package No. 20 –
investigated object No. 20



Figure 73 – View of handbag retrieved from package No. 21 –
investigated object No. 21



Figure 74 – View of items retrieved from package No. 22 –
group of investigated objects No. 22



Figure 75 – View of jeans retrieved from package No. 23 –
investigated object No. 23



Figure 76 – View of items retrieved from package No. 24 – group of investigated objects No. 24



Figure 77 – View of damage and brownish-red deposits on jeans from group of investigated objects No. 24



Figure 78 – View of gauze pad retrieved from package No. 25 – investigated object No. 25



Figure 79 – View of reference example of an SPM mine with VZD-1M fuze (view of inner casing structure with the cover off)



Figure 80 – View of additional detonator cup in SPM mine casing (close-up)

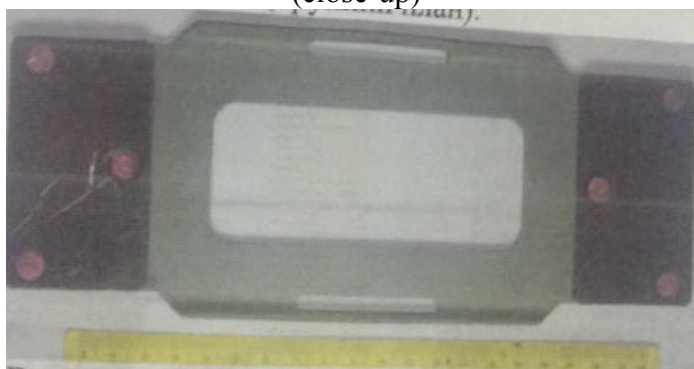

Figure 81 – View of reference example – steel plate for an SPM mine (view of the side connecting to magnets)

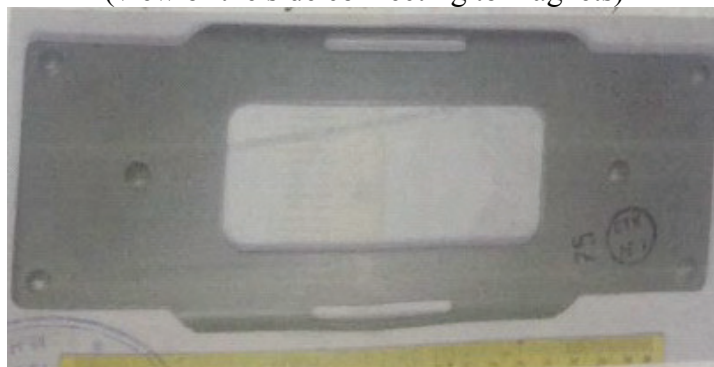
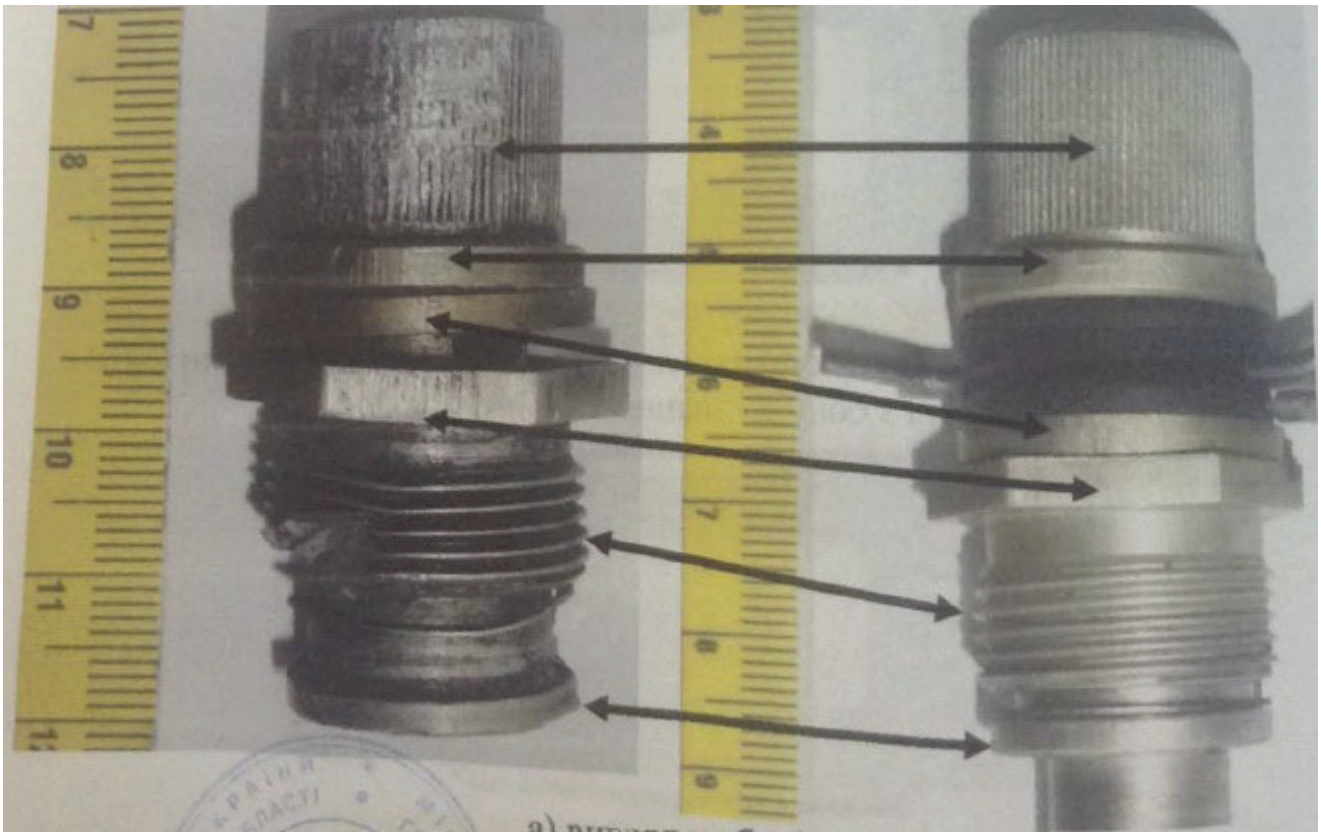

Figure 82 – View of reference example – steel plate for an SPM mine (view of outer surface)



Figure 83 – View of reference example – VZD-1M fuze



a) assembled state

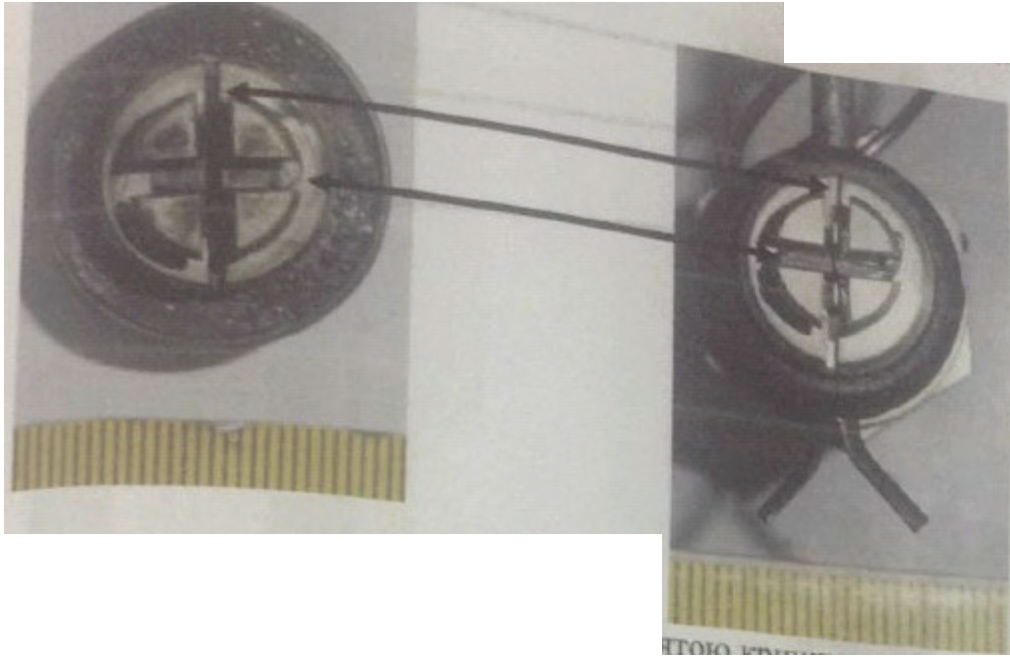

b) top side with the cover off

Figure 84 – Comparative photo of investigated object No. 8 (left) with VZD-1M fuze (right). Arrows point to shared characteristics.



Figure 85 – Comparative photo of group of investigated objects No. 13.1 (left) with the external end of a cup (with dent to fit a wrench) for fitting a fuze from the mine casing (right). Arrows point to shared characteristics.

[seal:] Forensic Research Center No. 12 Kharkiv Region
Main Directorate Ministry of Internal Affairs of Ukraine
Forensic expert [signature]

D.A. Karakurkchi

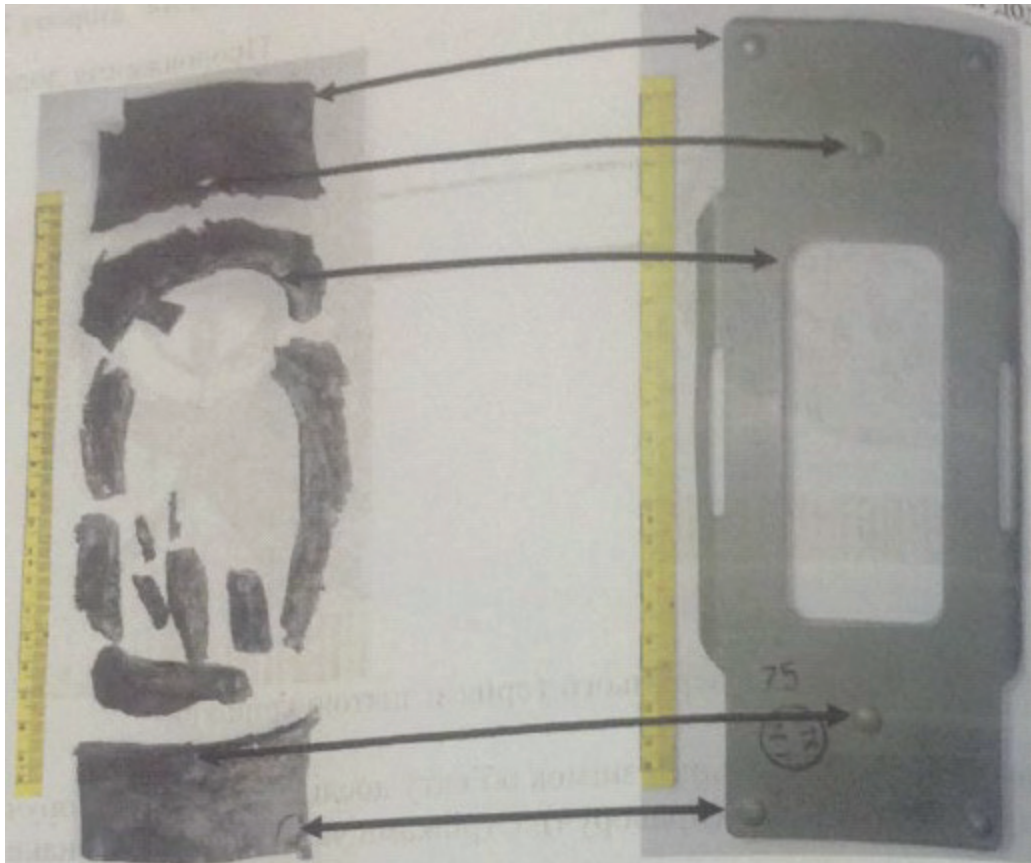

a) external surface

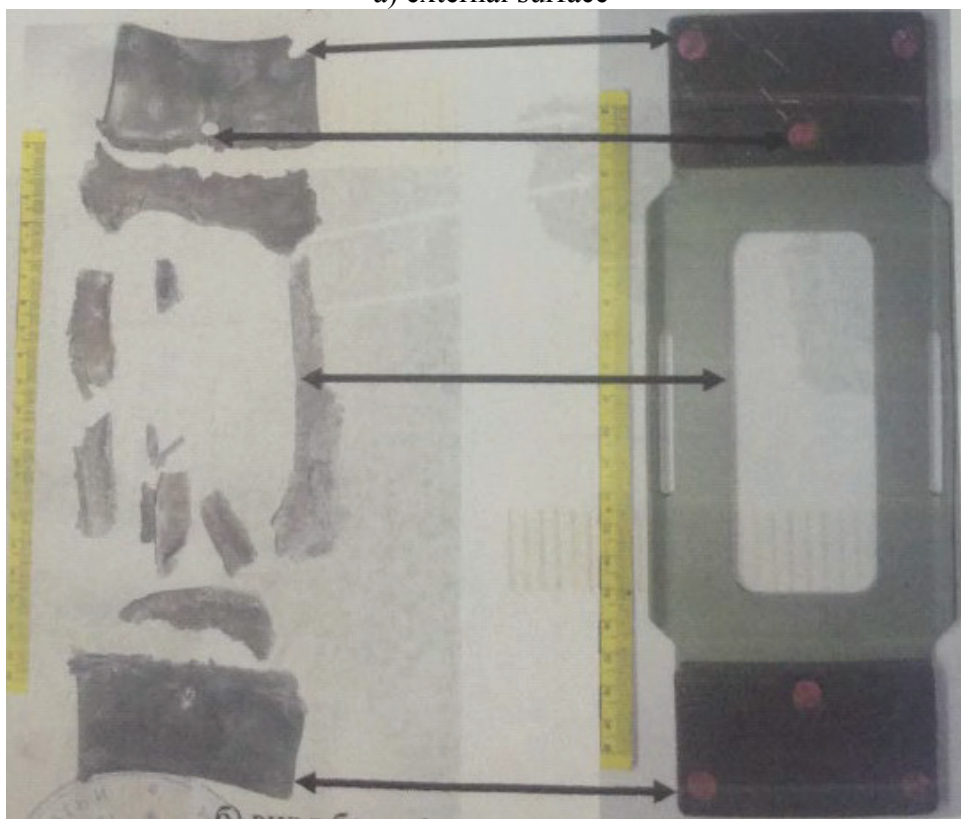

b) side connecting to magnets

Figure 86 – Comparative photo of group of investigated objects No. 16.1 (left) with steel plate for SPM mine (right). Arrows point to shared characteristics.

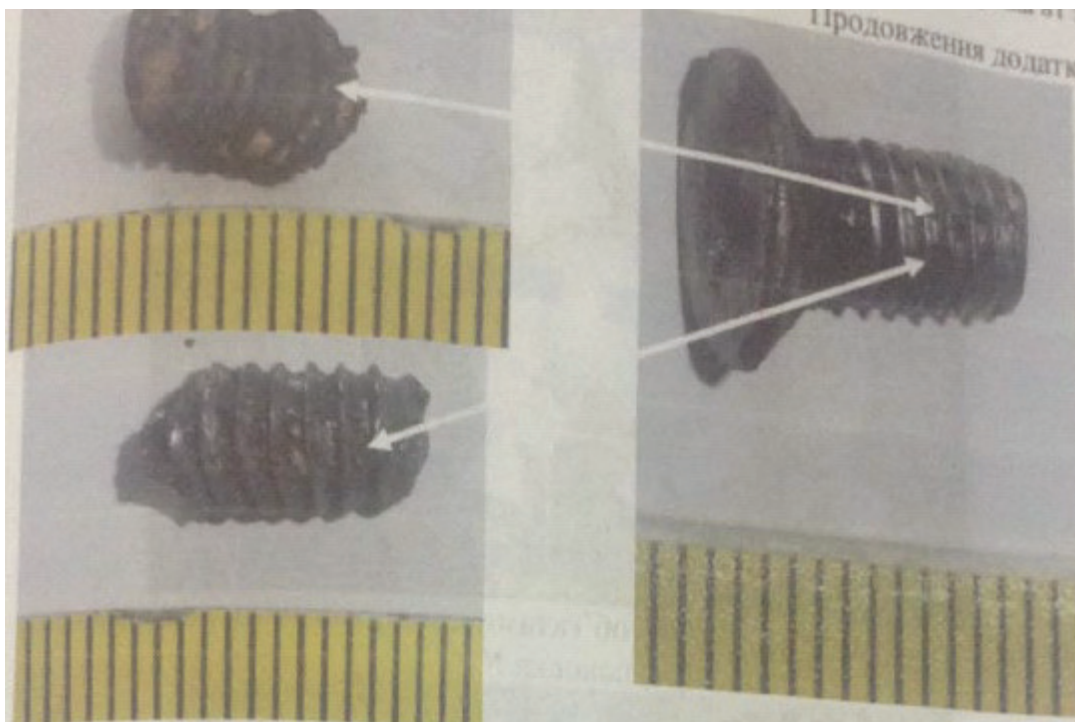

Figure 87 – Comparative photo of group of investigated objects No. 13.2 and 16.3 (left) with fixing bolt from the cover of SPM mine casing (right). Arrows point to shared characteristics.



Figure 88 – View of bags with investigated objects prior to handover to client
(package No. 1 – No. 7)



Figure 89 – View of bags with investigated objects prior to handover to client
(package No. 8 – No. 17)



Figure 90 – View of bags with investigated objects prior to handover to client
(package No. 18 – No. 23)



Figure 91 – View of bags with investigated objects prior to handover to client
(package No. 24, No. 25)

MINISTRY OF INTERNAL AFFAIRS OF UKRAINE
MAIN DIRECTORATE OF THE MINISTRY OF INTERNAL AFFAIRS OF UKRAINE
IN KHARKIV REGION

FORENSIC RESEARCH CENTER

34 vul.Kovtuna, Kharkiv

Tel. (057)721-23-39

vvtptd_kharkov@ukr.net

NOTE

on expenses incurred for conducting forensic explosive analysis No. 532/201 of 04.03.2015 as part of criminal proceedings No. 22014220000000305.

Customer: senior forensic investigator, Senior Lieutenant of Justice I.M. Babak of the investigations department at the Kharkiv Regional directorate of the Security Service of Ukraine.

No. of expert hours	Degree of analysis complexity	Cost of 1 expert hour, hryvnia, without VAT	Expenses incurred during analysis
1	2	3	4
82	special complexity	92.33	7571.06
Total			7571.06

Charge code 24060300, account No. 31419544700005

Bank code 37999680 MFO 851011

Remote bank access, Komintern district in Kharkiv

**Head of fire forensics sector,
forensic fire and explosives analysis department,**

Forensic Research Center

Kharkiv Region Main Directorate

Ministry of Internal Affairs of Ukraine

Police Lieutenant-Colonel

[signature]

D.A. Karakurkchi

**Head of explosive forensics sector,
forensic fire and explosives analysis department,**

Forensic Research Center

Kharkiv Region Main Directorate

Ministry of Internal Affairs of Ukraine

Police Lieutenant-Colonel

[signature]

I.V. Vislov

[seal: Forensic Research Center No. 12 Kharkiv Region
Main Directorate Ministry of Internal Affairs of Ukraine]

Forensic expert [signature]

D.A. Karakurkchi

Annex 117

Expert Opinion No. 143, drafted by the Ukrainian Scientific Research Institute of Special Equipment and Forensic Expert Examination, Security Service of Ukraine (3 April 2015)

This document has been translated from its original language into English, an official language of the Court, pursuant to Rules of the Court, Article 51.

Pursuant to Rules of the Court Article 51(3), Ukraine has translated only an extract of the original document constituting this Annex. In further compliance with this Rule, Ukraine has provided two certified copies of the full original-language document



SECURITY SERVICE OF UKRAINE
**Ukrainian Scientific Research Institute of Special Equipment
 and Forensic Expert Examination**
EXPERT OPINION

04/03/2015

City of Mariupol

No. 143

Counterpart No. 1

We, Serhiy Vitaliyovych Zholak, chief specialist (expert) of Section 6, Center 4 (Center for Forensic and Special Expert Examinations) of the Ukrainian Scientific Research Institute of Special Equipment and Forensic Expert Examination of the Security Service of Ukraine, higher technical education, special expert training and experience working as an expert since 2002, qualified forensic expert with the right to conduct explosives expert examinations with specializations in “Studying explosive devices, traces and the circumstances of explosions” (Certificate No. 503 issued by the Examination and Qualification Commission of the Security Service of Ukraine on 11/28/2013) and “Predicting the potential consequences of using explosive devices” (Certificate No. 504, issued by the Examination and Qualification Commission of the Security Service of Ukraine on 11/28/2013), and Ivan Hryhorovych Borozenets, chief specialist (expert) of Section 6, Center 4 (Center for Forensic and Special Expert Examinations) of the Ukrainian Scientific Research Institute of Special Equipment and Forensic Expert Examination of the Security Service of Ukraine, higher technical and legal education, special expert training and experience working as an expert since 2013, qualified forensic expert with the right to conduct explosives examinations with specializations in “Studying explosive devices, traces and the circumstances of explosions” (Certificate No. 481 issued by the Examination and Qualification Commission of the Security Service of Ukraine on 03/13/2013) and “Predicting the potential consequences of using explosive devices” (Certificate No. 482, issued by the Examination and Qualification Commission of the Security Service of Ukraine on 03/13/2013), pursuant to the Order on the Commissioning of an Explosives Expert Examination dated 02/27/2015, issued in the city of Mariupol by Senior Lieutenant O.V. Starostenko, a senior criminal investigator with the Investigations Department of the Donetsk Regional Directorate of the Security Service of Ukraine, carried out an expert examination based on the files of criminal proceeding No. 2201505000000047.

We are familiar with the facts of the case from the order on commissioning an expert examination.

Together with Letter No. 56/13-1071nt of 03/02/2015 (incoming ref. No. 877nt of 03.02.2015), the following items were received for examination:

- files of the criminal proceedings;
- three metal fragments of indefinite shape, recovered from the road near 58 vul. Landshaftna, packed in polyethylene bag No. 1 (inspection report for sector No. 1);
- metal fragment of indefinite shape bearing the letters and numbers “F 82 V OI” and a symbol in the form of a star, in

Investigations Department of the SBU Directorate, to ref. No. 1302nt: [illegible]

[signature]

the middle of which is the number "4", recovered from the courtyard of 64 vul. Kyivska, packed in bag No. 2 (inspection report for sector No. 1);

- a metal fragment measuring 8x19 bearing letter and number markings "4 87 VS N" and the partial image of a star, and 5 metal fragments of various shapes recovered from the athletics field of Comprehensive School No. 5 at 72 vul. Kyivska, packed in bag No. 3 (inspection report for sector No. 1);
- 2 metal fragments of indefinite shape, recovered near the building of kindergarten No. 160 at 171 vul. Olimpiyska, packed in bag No. 4 (inspection report for sector No. 1);
- 2 metal objects (fragments) measuring 45x10 cm with the numbers "18T-86-179-SV" and "V-49", and measuring 20x10 with number "4 18 V I N", recovered from the grounds of a house at 326 Olimpiyska (inspection report for sector No. 2);
- metal fragment measuring 18x7 cm with the inscription "Sh 47 V N I * 4" embossed in the metal recovered 4 m from the entrance to a building at 68 vul. Zoryana (inspection report for sector No. 2);
- 2 metal fragments recovered at 50 vul. Kuzbaska (inspection report for sector No. 2);
- metal piece (fragment) of irregular shape measuring 20x10 cm with No. F 79 V I N, recovered from the carriageway of the street next to the building located at 109 per. Poletayeva (inspection report for sector No. 2);
- metal fragment measuring 15x5 cm with the inscription "GpI-56d" embossed in the metal, recovered behind the building of a home located at 104 Zvenihorodska (inspection report for sector No. 2);
- metal object 22 cm in width, 19 cm in length, recovered from the road between the buildings located at 34 and 35 vul. Zoryana, packed in bag No. 1 (inspection report for sector No. 3);
- metal object 9 cm in length and 1 cm in maximum width recovered near the building located at 41 vul. Zoryana, packed in bag No. 2 (inspection report for sector No. 3);
- metal parts of deformed shape with torn edges, one of which is of cylindrical shape, has remnants of external threads on the ends, and bears the marking "KV" in black paint and the embossed stamp "1091" on its surface, recovered from the carriageway opposite No. 32 vul. Kyivska, packed in bag No. 1 (inspection report for sector No. 4);
- tail section of a cylindrical object recovered from the asphalt road opposite No. 44 vul. Kyivska, packed in bag No. 2 (inspection report for sector No. 4);
- 4 metal pieces, the largest measuring 12*4 cm and smallest 107*5 cm [sic], recovered from the carriageway opposite No. 34 vul. Kyivska, packed in bag No. 3 (inspection report for sector No. 4).

[signature]

- metal object with a sheared top, measuring approximately 10.8 cm with a maximum diameter of 5 cm and a minimum diameter of 1.8 cm, a hole visible on the inside measuring 22 mm, and the embossed stamp “MRV-U; 42-M; 46-83 visible on the surface of the lower section, recovered near No. 33a vul. Kyivska, packed in bag No. 4 (inspection report for sector No. 4);
- three metal pieces measuring from 10.5x2.5 to 18.8x7.5 cm, the largest piece bearing the embossed stamp “96 VNK Z”, recovered from Apt. 39B, 48/2 vul. Kyivska, packed in bag No. 5 (inspection report for sector No. 4);
- 8 metal objects measuring approximately 1-2 cm, recovered from the athletics field opposite No. 48/3 vul. Kyivska, packed in bag No. 6 (inspection report for sector No. 4);
- bag sealed with a paper label with an explanatory note and the signatures of the investigator and participants in the inspection, which contains two deformed metal parts measuring 11.6 and 9.8 cm respectively recovered in the course of inspecting the incident site on 01/25/2015, near the building located at 39 vul. Kyivska, Mariupol;
- bag sealed with a paper label with an explanatory note and the signatures of the investigator and participants in the inspection, which contains two deformed metal fragments and one metal object of irregular shape measuring 16*15 cm, recovered in the course of inspecting the incident site on 01/25/2015, near the building located at 62 vul. Kyivska, Mariupol;
- bag sealed with a paper label with an explanatory note and the signatures of the investigator and participants in the inspection, which contains two deformed metal fragments of an article, recovered in the course of inspecting the incident site on 01/25/2015, near the building located at 72 vul. Kyivska, Mariupol;
- bag sealed with a paper label with an explanatory note and the signatures of the investigator and participants in the inspection, which contains two deformed metal fragments measuring 2x4 cm and 3.5x4 cm respectively, recovered in the course of inspecting the incident site on 01/25/2015, near the building located at 78 vul. Kyivska, Mariupol;
- bag sealed with a paper label with an explanatory note and the signatures of the investigator and participants in the inspection, which contains metal fragments recovered in the course of inspecting the incident site on 01/25/2015, near the building located at 49 vul. Kuzbaska, Mariupol;
- bag sealed with a paper label with an explanatory note and the signatures of the investigator and participants in the inspection, which contains two grey metal fragments recovered in the course of inspecting the incident site on 01/25/2015, near the building located at 19 vul. Marshrutna, Mariupol;
- bag sealed with a paper label with an explanatory note and the signatures of the investigator and participants in the inspection, which contains one

[signature]

grey metal fragment recovered in the course of inspecting the incident site on 01/25/2015, near the building located at 14 pr. Yasnyi, Mariupol;

- copies of the report on the inspection involving the specialist dated 25.01.2015;

- topographical map from 1979 (scale 1:50,000).

The expert panel was asked to answer the following questions:

1. Based on the inspection of the incident site and the recovered objects, what caused the explosion(s)?
2. Based on the inspection of the incident site and the recovered objects, is it possible to identify the type and sort of munitions, the detonation of which resulted in the explosion(s); the type and sort of weapon (artillery system or other type of armament) that was used to fire the munitions, fragments of which and explosive traces of which were found in the course of inspecting the incident site, and, if so, what type and sort of munitions were detonated and from what type of sort of weapon were they fired?
3. Do the objects recovered during the inspection of the incident site and submitted for expert examination bear any markings that would make it possible to identify the type and sort of munitions or other identifying marks of the munitions that were detonated?
4. Based on the inspection of the incident site and the recovered objects, was there a detonation of munitions fired from an artillery system or other type of weapon, or a detonation of stationary, planted munitions or explosive devices (in the latter case, which type and sort of stationary, planted munitions or explosive devices)?
5. What quantity of munitions (explosive devices) was activated, based on the results of the inspection of the incident site and explosive traces recorded in the report on the inspection of the incident site and objects recovered during the inspection of the incident site and the submitted video recordings?
6. What was the power of the munitions (explosive device, explosive charge), in explosive equivalent, the activation (initiation) of which led to the explosion?
7. Which of the fragments recovered during the inspection of the incident site are fragments of munitions (explosive devices), and what is the purpose of each component of the munitions (explosive devices), fragments of which were recovered during the inspection of the incident site.
8. Is it possible, based on the inspection of the incident site and the objects discovered during the inspection of the incident site, to draw any conclusions as to the direction(s) from which the munitions, the detonation of which was recorded during the inspection of the incident site, were fired, as well as the distance from which these munitions were fired and, if so, from which direction(s) and distance respectively were these munitions fired?

[signature]

9. Is it possible, based on the inspection of the incident site and the objects found during the inspection of the incident site, to draw any conclusions as to the angle of incidence of the munitions, the detonation of which was recorded during the inspection of the incident site, and, if so, then what was the angle of incidence of the munitions, the detonation of which was recorded during the incident site inspection, and what firing distance of the munitions is consistent with their established angle of incidence?

The following information sources were used in conducting the expert examination:

- *“Methods of Complex Examination of Explosive Devices, Substances and Traces” (H.V. Prokhorov-Lukin, V.I. Pashchenko, V.I. Bykov, et al – Kyiv: Elite Print LLC, 2011 – 216 p.: ill.);*
- *“Mass Produced Explosive Devices and Their Forensic Examination” (Yu.M. Dildin, V.V. Martynov, Expert Consulting Center of the Ministry of Internal Affairs of the Russian Federation. Moscow. 1991);*
- *“Explosives Expert Book: a Study Guide and Methodological Handbook” (Moscow 2001);*
- *“Tables of Fire from M-21-OF High-Explosive Fragmentation Rocket-Propelled Shells (Ministry of Defense of the USSR, Moscow 1975).*
- *“Technical Description. BM-21 Combat Vehicle (Ministry of Defense of the USSR, Moscow 1971).*
- *“MRV-U Fuse. Handbook” (Ministry of Defense, Moscow 1973).*

The experts have been warned of the potential liability for presenting knowingly inaccurate findings and for refusing without a valid reason to perform their duties under Articles 384 and 385 of the Criminal Code of Ukraine.

[signature] S. Zholak

[signature] I. Borozenets

EXAMINATION

The items submitted for examination were packed in accordance with the rules for the storage and transportation of physical evidence.

The examination was conducted visually under laboratory conditions in daylight at an air temperature of +20 °C.

The following instruments and devices were used:

- caliper No. 51207638
- metal ruler GOST 427-56;
- forensic tape measure SV-1
- magnifying glass with 4x magnification;
- OLYMPUS x-775 camera.

[signature]

The subject matter of the examination consists of metal fragments of irregular and cylindrical shape. All of the fragments show signs of deformation: metal tearing, indentations and scratches. The inspection revealed that the metal fragments have the following dimensions:

- three metal fragments of subsurface use of irregular shape with torn edges, grey in color, measuring 550x250x3mm (object No. 1), 190x15x3mm (object No. 2), 130x33x3mm (object No. 3), (illustration No. 1);
- metal fragment of irregular shape with torn edges, grey in color, measuring 200x79x3mm (object No. 4) bearing the letter and number markings "f 82 V OI" and a symbol in the form of a star with a number "4" in the middle, (illustration No. 2);
- metal fragment measuring 80x190x4mm (object No. 5) bearing the letter and number markings "4 87 VS N" and the partial image of a star, and 5 metal fragments of irregular shape with torn edges, grey in color (object No. 6), (illustrations Nos. 3, 4, 5);
- 2 metal fragments of irregular shape with torn edges, grey in color, measuring 12x11x4mm and 16x11x4mm (objects No. 7), (illustration No. 6);
- 2 metal fragments of irregular shape with torn edges, grey in color, measuring 450x100x4mm with the numbers "18T-86-179-SV" and "V-49" (object No. 8) and 19x90x4mm (object No. 9) with the number "4 18 V I N", (illustrations Nos. 7, 8, 9);
- metal fragment of irregular shape with torn edges, grey in color, measuring 180x70x4mm with the inscription "Sh 47 V N I * 4" (object No. 10), (illustrations Nos. 10, 11);
- 2 metal fragments of irregular shape with torn edges, grey in color, measuring 180x80x3mm with the number "Sh 62 VSI" (object No. 11) and 195x115x3mm (object No. 12), (illustrations No. 12, 13);
- metal piece (fragment) of irregular shape, grey in color, measuring 190x85x3mm with the number "F 79 V I N" (object No. 13) (illustration No. 14);
- metal fragment of irregular shape, grey in color, measuring 150x80x3mm with the inscription "GpI-56d" embossed in the metal (object No. 14) (illustrations Nos. 15, 16);
- metal fragment of irregular shape, grey in color, measuring 235x215x3mm (object No. 15) (illustration No. 17);
- metal fragment of irregular shape, grey in color, measuring 90x10x3mm (object No. 16) (illustration No. 18). A zigzag-shaped line is embossed on one side of the object;
- metal parts of deformed shape with torn edges; one of the parts is cylindrical in shape and measures 360x20x4mm; it has remnants of an external thread on its ends and the marking "KV" in black marker on its surface, and is embossed "1091"(object No. 17) (illustrations Nos. 19, 20);

[signature]

- a fragment consisting of 2 grey metal fragments: the tail section of a cylindrical object measuring 800x280x4mm and embossed "3 PP 1 TD AT Ukraine" (object No. 18) and a metal fragment of irregular shape, grey in color, measuring 580x180x4 mm and embossed "Zh . V O I" (object No. 18.1) (illustrations Nos. 21, 22, 23, 24);
- four grey metal pieces, the largest measuring 90x85x4mm and the smallest measuring 659x30x4mm (objects Nos. 19, 19.1, 20, 21) (illustration No. 25);
- grey metal object with a sheared top, measuring approximately 110 mm with a maximum diameter of 50 mm and a minimum diameter of 18 mm, a hole visible on the inside measuring 22 mm, and the embossed marking "MRV-U; 42-M"; 46-83 visible on the surface of the lower section (object No. 22) (illustration No. 26);
- three metal pieces of irregular shape, grey in color, measuring from 105x25mm to 188x75mm, the largest piece bearing the embossed stamp "96 VNK Z" (objects Nos. 23, 24, 25) (illustrations Nos. 27, 28);
- 8 metal objects of irregular shape, grey in color, measuring approximately 10-20mm (object No. 26) (illustration No. 28);
- two deformed metal parts, grey in color: an object in the form of a wire with a spring measuring 116mm in length (object No. 27) and a metal fragment of irregular shape measuring 90x80x3mm (object No. 28) (illustration No. 29);
- two metal fragments of irregular shape, grey in color: one measuring 170x75x3mm with the inscription "M 6 V I I" embossed in the metal (object No. 29), and the other measuring 170x25x3mm (object No. 31), and one metal object of irregular shape, grey in color, measuring 310x155x4mm (object No. 30) (illustrations Nos. 30, 31);
- seven metal fragments of irregular shape with torn edges, grey in color, measuring 525x190x4mm (object No. 32), 150x260x4mm (object No. 33), 50x305x3mm (object No. 34), 260x40x4mm (object No. 35), 380x60x4mm (object No. 36), 320x40x3mm (object No. 37), 170x160x4mm (object No. 38) (illustration No. 32);
- two metal fragments of irregular shape, grey in color, measuring 355x120x4mm (object No. 39) and measuring 195x165x3mm (object No. 40) (illustration No. 33);
- five metal fragments of irregular shape with torn edges, grey in color, measuring 265x136x4mm (object No. 41), 90x60x4mm (object No. 42), 80x160x3mm (object No. 43), 80x35x4mm (object No. 44), and 177x75x4mm with the inscription "F 70 V O I" embossed in the metal (object No. 45) (illustrations Nos. 34, 35).

[signature]

- two metal fragments of irregular shape, grey in color, measuring 35x40x4mm (object No. 46) and measuring 20x40x4mm (object No. 47) (illustration No. 36);
- two metal fragments of oblong shape, grey in color, measuring 147mm in length with a maximum thickness of 15mm (object No. 48) (illustration No. 37). A zigzag-shaped line is embossed on one side of the object;
- grey metal object with a sheared top, measuring approximately 95mm in length with a maximum diameter of 54mm and a minimum diameter of 18mm, a hole visible on the inside measuring 21mm, and the embossed stamp "MRV-U; 42-M; 46-83" visible on the surface of the lower section (object No. 49) (illustration No. 38);
- two metal fragments of irregular shape, grey in color: one measuring 179x90x4mm with the inscription "Z 99 V S I" embossed in the metal (object No. 50), and the other measuring 199x77x4mm with the inscription "56 V O N" embossed in the metal (object No. 51) (illustrations Nos. 39, 40, 41).

All of the metal objects (objects No. 1-51) submitted for examination show signs of deformation.

The examination of objects No. 1-51 revealed:

- longitudinal grooves in the form of threads (object No. 17);
- markings in the form of letters and numbers:
 - A) "f 82 V OI" (object No. 4, illustration No. 2);
 - B) "4 87 VS N" (object No. 5, illustration No. 4);
 - C) "V-49" "18T-86-179-SV" (object No. 8, illustrations Nos. 8, 9);
 - D) "Sh 47 V NI" (object No. 10, illustration No. 11);
 - E) "Sh 62 N SI" (object No. 11, illustration No. 13);
 - F) "GpI-56d" (object No. 14, illustration No. 16);
 - G) "10-91" (object No. 17, illustration No. 20);
 - H) "3 PP 1 TD AT U", "Zh... V O I" (object No. 18, illustrations Nos. 23, 24);
 - I) "MRV-U; 42-M; 46-83" (objects Nos. 22, 49, illustrations Nos. 26, 38), where:
 - "MRV-U" is the demolition specialist's mark;
 - "42-M" is the factory number;
 - "46" is the lot number;
 - "83" is the year of manufacture (1983)
 - J) "96 VNK Z" (object No. 24, illustration No. 28);
 - K) "M 6 V I I" (object No. 29, illustration No. 31);
 - L) "F 70 V O I" (object No. 45, illustration No. 35);
 - M) "Z 99 V S I" (object No. 50, illustration No. 40);
 - N) "56 V O N" (object No. 51, illustration No. 41);

Because the experts do not have access to the technical specifications for M-21 OF shells, it does not appear possible to determine the meanings of the markings preserved on the remnants of the shells (except for those denoted in section "I").

[signature]

Parts of markings were also found on a number of objects but could not be identified due to the significant deformation of the objects and thermal influence on them during firing and detonation.

Metal pins measuring ~4 mm in diameter and ~70 mm in length and wound with wire in the form of a spring 1.7 mm in diameter were attached to object No. 17. On one side is a plate (deformed) with apertures measuring ~15 mm in diameter, while on the other side traces of thermal influence can be seen in the form of chaotically spaced indentations of irregular shape with melted edges and black stratification (which appears to be soot) (illustration No. 42).

In order to answer the questions that were posed, submitted object No. 17 was compared with the corresponding parameters indicated in the standard technical documentation. The results of this examination are shown in Table No. 1.

Comparative Table No. 1

Features of basic components	Subject of comparison	Examined object
	Stabilizer unit	Object similar to part of stabilizer unit (object No. 17)
Material of construction	grey metal	grey metal
Number of blades	4	4 apertures for blade attachment
Diameter, mm	122	~116-122
Number of nozzle holes	7	7
Hole for positioning screw	yes	yes

Based on a comparison with the drawings in the reference literature and the indicated dimensions, object No. 17 is part of a stabilizer unit for an unguided M-21 OF rocket-propelled high-explosive fragmentation shell (illustrations Nos. 42, 43 and 44).

In order to answer the questions that were posed, submitted objects Nos. 6, 7, 16, 26 and 48 were compared with the corresponding parameters indicated in the standard technical documentation. The results of this examination are shown in Table No. 2.

Comparative Table No. 2

Features of basic components	Subject of comparison	Examined object
	pre-set fragmentation element of unguided M-21-OF rocket-propelled high-explosive fragmentation shell	Objects similar to fragmentation elements (objects Nos. 6, 7, 16, 26 and 48)
Material of construction	grey metal	grey metal
Weight, g	2.4	2.25-2.48
Geometric shape	diamond	diamond

A comparative analysis indicates that in terms of external appearance, material of construction, and structural properties, submitted objects Nos. 6, 7, 16, 26, and 48 are

[signature]

standard fragmentation elements of a 122mm unguided M-21 OF rocket-propelled high-explosive fragmentation shell (item 9M22U) (illustrations Nos. 45, 46 and 47).

In order to answer the questions that were posed, submitted objects Nos. 22 and 49 were compared with the corresponding parameters indicated in the standard technical documentation. The results of this examination are shown in Table No. 3.

Comparative Table No. 3

Features of basic components	Subject of comparison	Examined object
	MRV-U fuse	Objects similar to MRV-U fuses (objects Nos. 22 and 49)
Material of construction	grey metal	grey metal
Total length, mm	93.6	92-94
Geometric shape	cone	cone
Maximum diameter, mm	48.5	49-49.3
Markings present	yes	yes

A comparative analysis and examination of the markings indicates that in terms of their external appearance, material of construction and structural properties, submitted objects Nos. 22 and 49 are parts of an MRV-U percussion fuse, semi-detonator safe, with a remote trigger (switch to armed position after firing occurs at a distance of 150-450 meters), which is used as a standard fuse for a 122-mm unguided M-21 OF rocket-propelled high-explosive fragmentation shell (item 9M22U).

Objects Nos. 1-5, 8-15, 18-21, 23-25, 27-38, 41-50 and 51 are parts of the bodies of 122mm unguided M-21 OF rocket-propelled high-explosive fragmentation shells (item 9M22U) (illustrations Nos. 48-50).

The examination of objects Nos. 39-40 revealed distinguishing features in comparison with the other objects (thickness, color of surface coating, material of construction), on which basis we may conclude that they are not parts of the bodies of M-21 OF rocket-propelled high-explosive fragmentation shells, but are probably parts of a different metal structure.

Based on the copies of the inspection reports for sectors Nos. 1-4, which were submitted for expert examination, and a comparative analysis of the recovered objects, it was established that the cause of the explosions was artillery shelling with unguided M-21 OF rocket-propelled high-explosive fragmentation shells.

Based on copies of the reports on the inspection of the incident site and recovered objects, it is possible to identify the specific type and sort of munitions as 122mm unguided M-21 OF rocket-propelled high-explosive fragmentation shells (item 9M22U). These shells were fired from BM 21 Grad multiple rocket launchers.

The question of the amount of firing of munitions goes beyond the experts' scope of competence. Based on the copies of inspections reports for sectors Nos. 1-4 submitted for expert examination, at least 124 shells fired from BM 21 Grad multiple rocket launchers were detonated.

[signature]

According to the standard literature *Explosives Expert Book: a Study Guide and Methodological Handbook* (Moscow 2001), nearly all rocket-propelled shells contain the explosive substance A-IX-2. In this case, according to the technical specifications of the 122mm unguided M-21 OF rocket-propelled high-explosive fragmentation shell (item 9M22U), the weight of the explosive substance is 6.4 kg.

The power of a munition is calculated according to the formula $Q=M_{\text{ex}} \times C_{\text{ex}}$, where:
 M_{ex} = mass of the explosive substance with which the munition (explosive device) is loaded (in kg)

C_{ex} = the coefficient, which depends on the heat or energy of the explosion; for the explosive substance A-IX-2, it is 1.46.

$$Q=6.4 \times 1.46=9.344 \text{ kg in TNT equivalent.}$$

Based on copies of the incident site inspection report, a copy of the report on the inspection involving the specialist dated 25.01.2015, and the topographical map, it is possible to draw the following conclusions:

- the shelling was probably conducted from an area to the northeast of the villages of Sakhanka and Leninske, Novoazovskyi District, Donetsk Region, from a distance of 16,400 to 17,800m;
- the angles of incidence of the munitions was 40° to 46°, which is consistent with a firing distance of 16,400 to 17,800 m, according to the firing table for M-21 OF high-explosive fragmentation shells (item 9M22U).

Based on an analysis of the examined items, traces of their deformation, and the incident site inspection reports, it is possible to draw the conclusion that formation of the blasts (shell craters, holes) was caused by detonations of 122mm unguided M-21 OF rocket-propelled high-explosive fragmentation shell (item 9M22U) as a result of artillery shelling.

CONCLUSIONS

1. Based on the inspection of the incident site and recovered objects, it was established that the explosions were caused by the detonation of unguided M-21 OF rocket-propelled high-explosive fragmentation shells.

2. Based on the inspection of the incident site and recovered objects, it is possible to identify the specific type and sort of munitions as 122mm unguided M-21 OF rocket-propelled high-explosive fragmentation shells (item 9M22U). These shells were fired from BM 21 Grad multiple rocket launchers.

3. Objects recovered during the inspection of the incident site and submitted for expert examination (objects Nos. 22 and 49) bear the following markings: "MRV-U; 42-M; 46-83", where "MRV-U" is the demolition specialist's mark, "42-M" is the factory number, "46" is the lot number, and "83" is the year of manufacture (1983).

It does not appear possible to answer the question as to meaning of the other markings preserved on the remnants of the shells for the reasons indicated in the examination section.

[signature]

4. Based on the characteristics of the recovered objects, the explosions were caused by detonations of shells fired from BM 21 Grad multiple rocket launchers.

5. Based on copies of the inspection reports for sectors Nos. 1-4 submitted for expert review, at least 124 shells were fired from BM 21 Grad multiple rocket launchers.

6. The power of one piece of ordnance (unguided M-21 OF rocket-propelled high-explosive fragmentation shell) is 9.344 kg in TNT equivalent;

7. Object No. 17 is part of the standard body of a stabilizer unit for an unguided M-21 OF rocket-propelled high-explosive fragmentation shell (item 9M22U), which is designed to stabilize the flight of a shell.

Objects Nos. 1-5, 8-15, 18-21, 23-25, 27-38, 41-50, and 51 are parts of bodies of 122mm unguided M-21 OF rocket-propelled high-explosive fragmentation shells (item 9M22U).

Objects Nos. 22 and 49 are parts of an MRV-U percussion fuse, semi-detonator safe, with a remote trigger, which is used to detonate the warhead of an M-21 OF high-explosive fragmentation shell (item 9M22U).

Objects Nos. 6, 7, 16, 26 and 48 are standard fragmentation elements of a 122mm unguided M-21 OF rocket-propelled high-explosive fragmentation shell (item 9M22U), designed to inflict losses on enemy personnel and unarmored equipment.

It does not appear possible to provide answers as to the purpose of each fragment submitted for examination due to the significant deformation of the said objects.

8. Based on copies of the incident site inspection report, a copy of the report on the inspection involving the specialist dated 25.01.2015, and the topographical map, the shelling was probably conducted from an area to the northeast of the villages of Sakhanka and Leninske, Novoazovskyi District, Donetsk Region, from a distance of 16,400 to 17,800m;

9. Based on the inspection of the incident site and the objects recovered during the inspection of the incident site, the angles of incidence of the munitions was 40° to 46°, which is consistent with a firing distance of 16,400 to 17,800m, according to the firing table for M-21 OF high-explosive fragmentation shells (item 9M22U).

Attached: table of illustrations, 11 pages

Experts

[signature] **S. Zholak**
[signature] **I. Borozenets**

[stamp: Donetsk Regional Directorate of the Security Service of Ukraine, No. 56/21-925nt, 04.03.2015]

[signature]

SECURITY SERVICE OF UKRAINE
TABLE OF ILLUSTRATIONS
TO EXPERT OPINION No. 143 of 04.03.2015

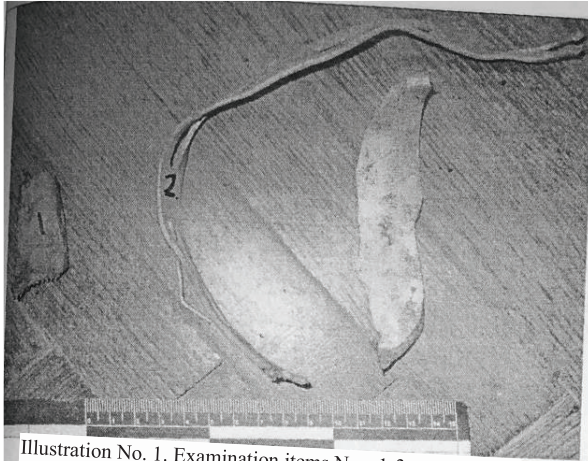

Illustration No. 1. Examination items Nos. 1-3

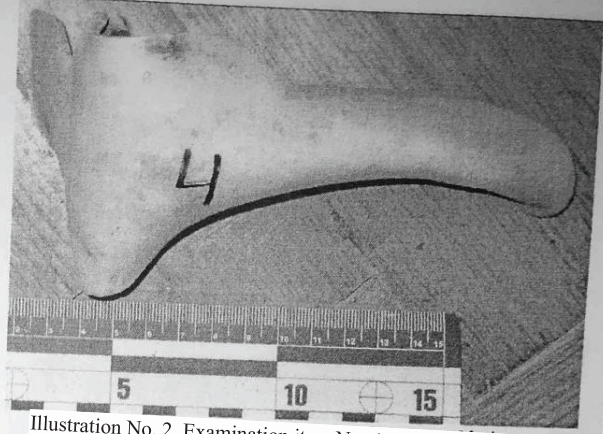

Illustration No. 2. Examination item No. 4

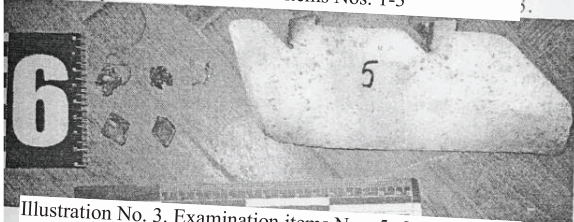

Illustration No. 3. Examination items Nos. 5, 6

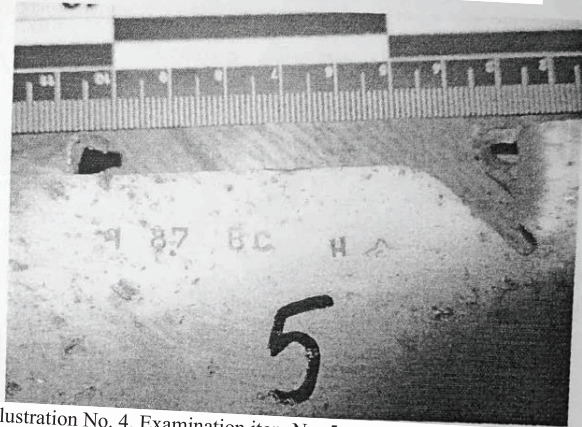

Illustration No. 4. Examination item No. 5



Illustration No. 5. Examination items No. 6



Illustration No. 6. Examination item No. 7

Experts

[signature]
[signature]

S. Zholak
I. Borozenets

SECURITY SERVICE OF UKRAINE
TABLE OF ILLUSTRATIONS
TO EXPERT OPINION No. 143 of 04.03.2015

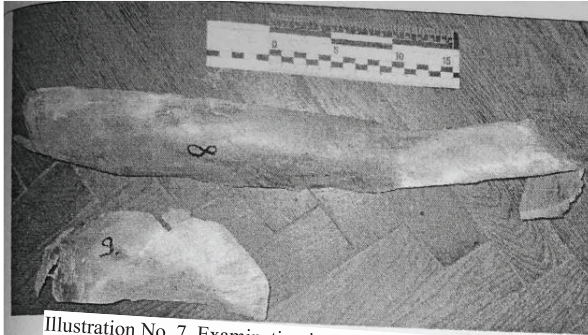

Illustration No. 7. Examination items Nos. 8, 9



Illustration No. 8. Markings on examination item No. 8

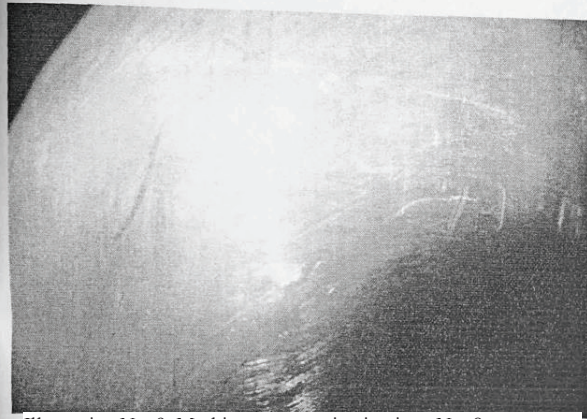

Illustration No. 9. Markings on examination item No. 8

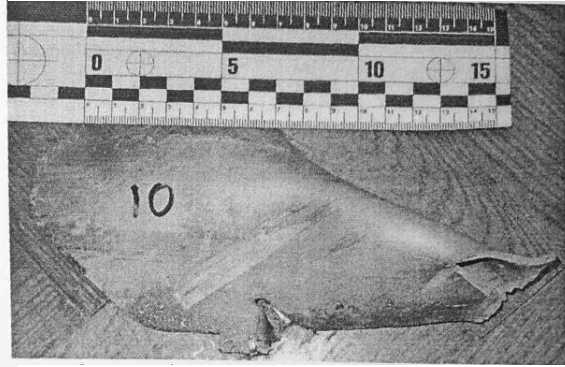

Illustration No. 10. Examination item No. 10

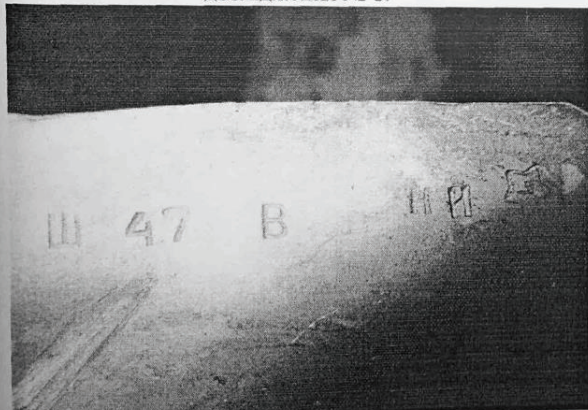

Illustration No. 11. Markings on examination item No. 10

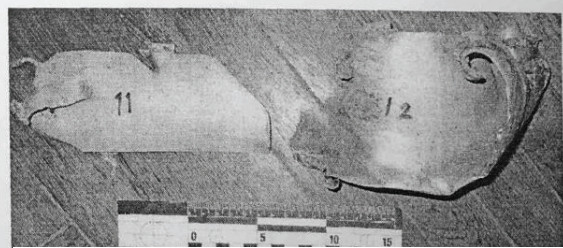

Illustration No. 12. Examination items Nos. 11, 12

Experts

[signature]
[signature]

S. Zholak
I. Borozenets

SECURITY SERVICE OF UKRAINE
TABLE OF ILLUSTRATIONS
TO EXPERT OPINION No. 143 of 04.03.2015

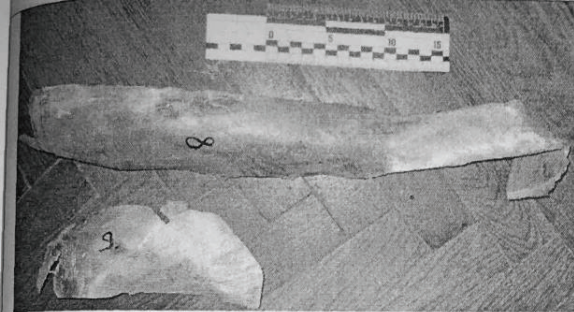

Illustration No. 7. Examination items Nos. 8, 9



Illustration No. 8. Markings on examination item No. 8

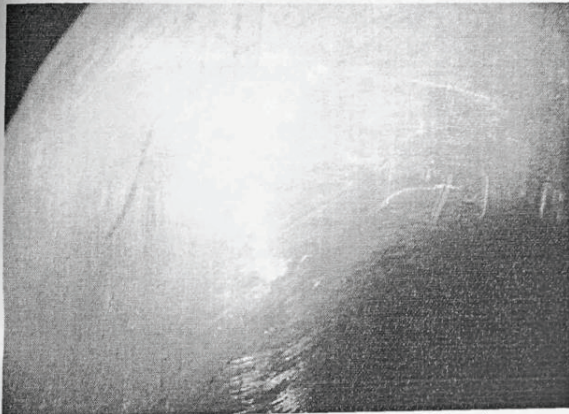

Illustration No. 9. Markings on examination item No. 8

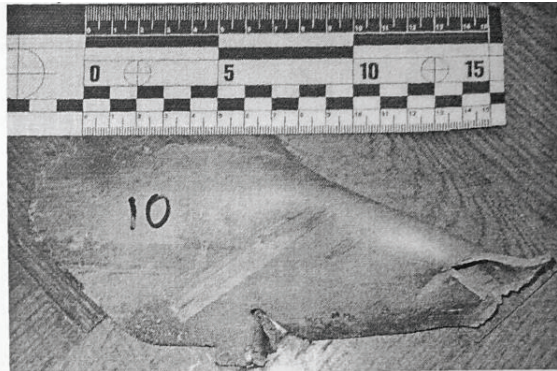

Illustration No. 10. Examination item No. 10

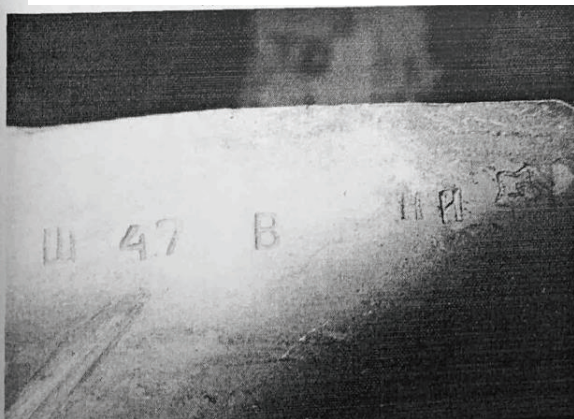

Illustration No. 11. Markings on examination item No. 10

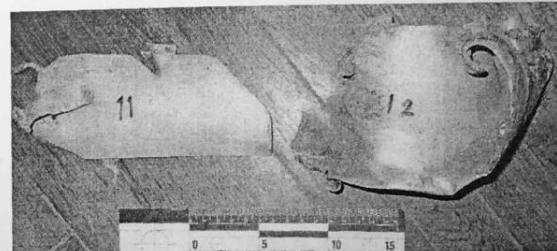

Illustration No. 12. Examination items Nos. 11, 12

Experts

[signature]

S. Zholak

[signature]

I. Borozenets

SECURITY SERVICE OF UKRAINE
TABLE OF ILLUSTRATIONS
TO EXPERT OPINION No. 143 of 04.03.2015

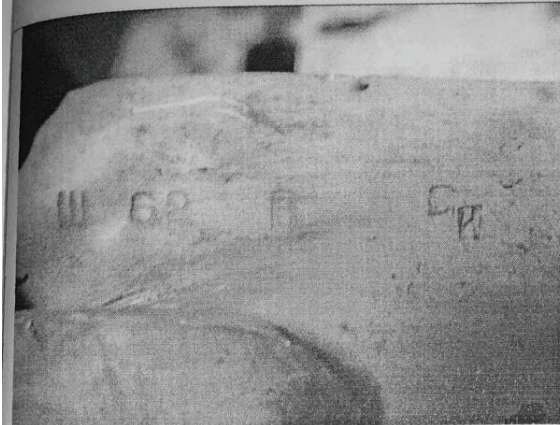

Illustration No. 13. Markings on examination item No. 11



Illustration No. 14. Examination item No. 13

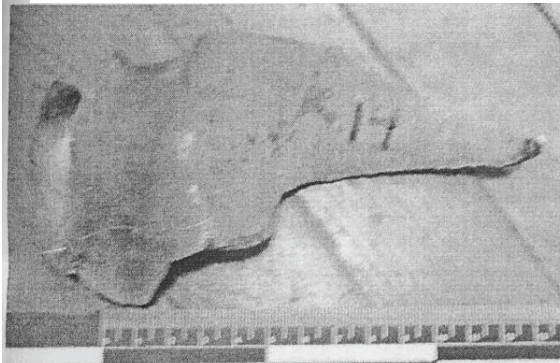

Illustration No. 15. Examination item No. 14

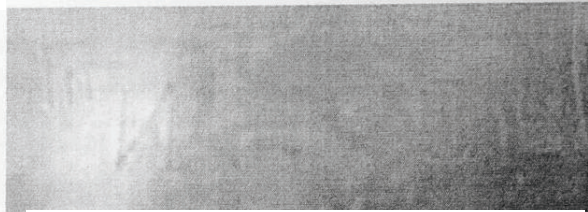

Illustration No. 16. Markings on examination item No. 14

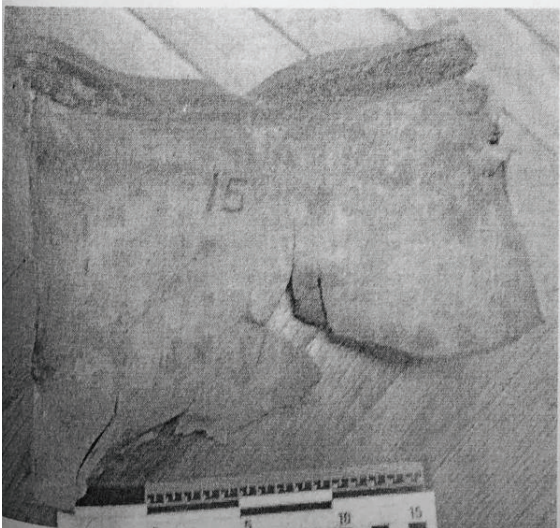

Illustration No. 17. Examination item No. 15



Illustration No. 18. Examination item No. 16

Experts

[signature]

S. Zholak

[signature]

I. Borozenets

SECURITY SERVICE OF UKRAINE
TABLE OF ILLUSTRATIONS
TO EXPERT OPINION No. 143 of 04.03.2015

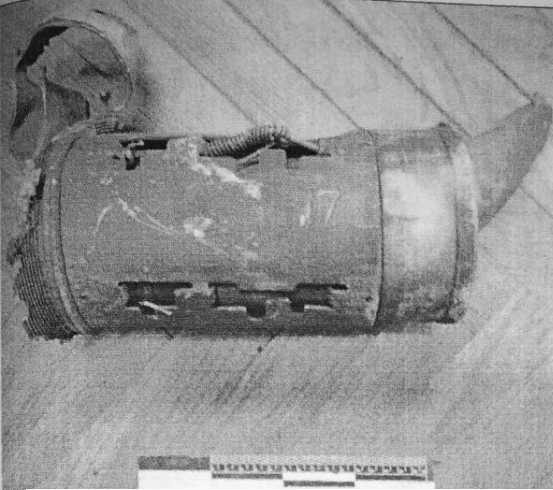

Illustration No. 19. Examination item No. 17

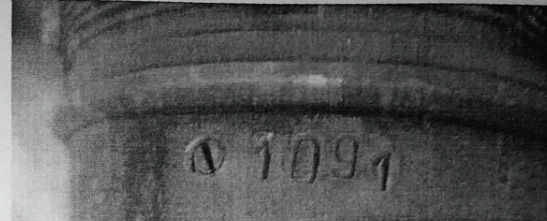

Illustration No. 20. Markings on examination item No. 17

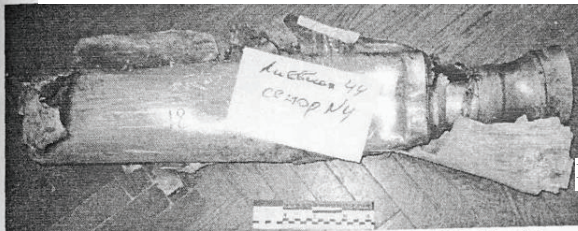

Illustration No. 21. Examination items Nos. 18, 18.1

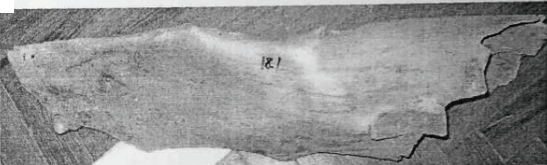

Illustration No. 22. Examination item No. 18.1



Illustration No. 23. Markings on examination item No. 18

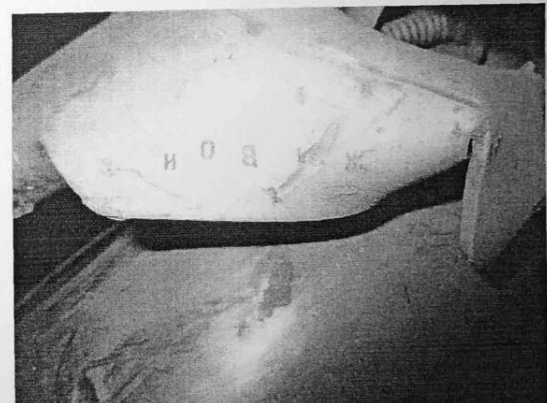

Illustration No. 24. Markings on examination item No. 18

Experts

[signature]

S. Zholak

[signature]

I. Borozenets

SECURITY SERVICE OF UKRAINE
TABLE OF ILLUSTRATIONS
TO EXPERT OPINION No. 143 of 04.03.2015



Illustration No. 25. Examination items Nos. 19, 19.1, 20, 21



Illustration No. 26. Examination item No. 22

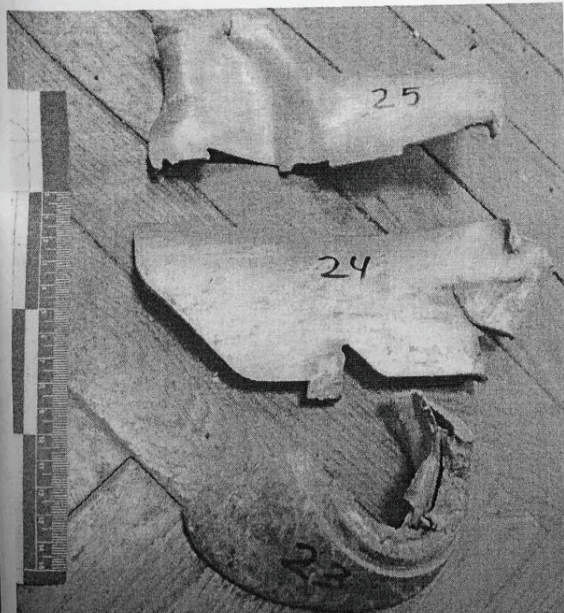

Illustration No. 27. Examination items Nos. 23-25



Illustration No. 28. Markings on examination item No. 24

Experts

[signature]

S. Zholak

[signature]

I. Borozenets

SECURITY SERVICE OF UKRAINE
TABLE OF ILLUSTRATIONS
TO EXPERT OPINION No. 143 of 04.03.2015
ДО ВИСНОВКУ ЕКСПЕРТА № 143 від 03.04.2015



Illustration No. 28. Examination item No. 26

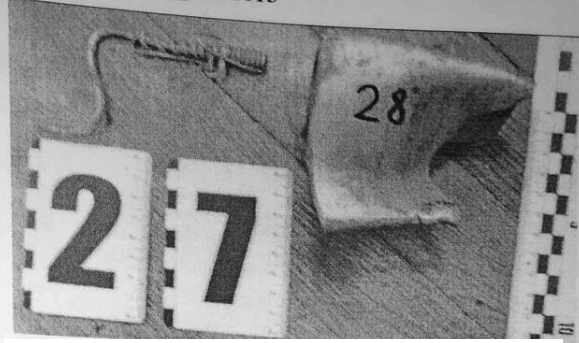

Illustration No. 29. Examination items Nos. 27, 28

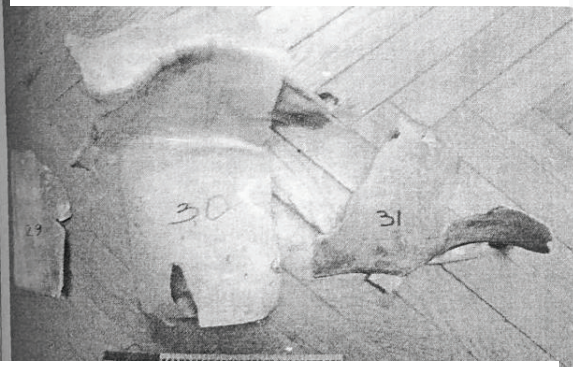

Illustration No. 30. Examination items Nos. 29-31



Illustration No. 31. Markings on examination item No. 29

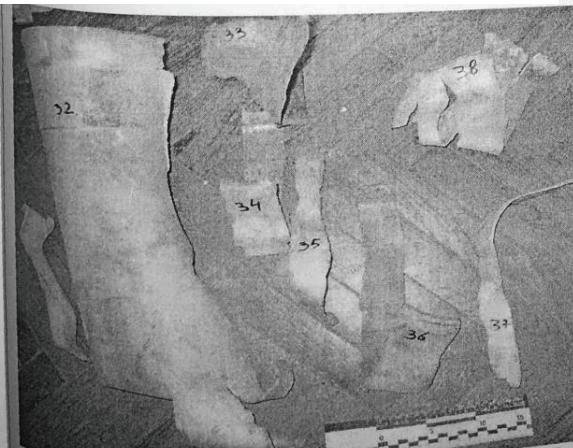

Illustration No. 32. Examination items Nos. 32-38

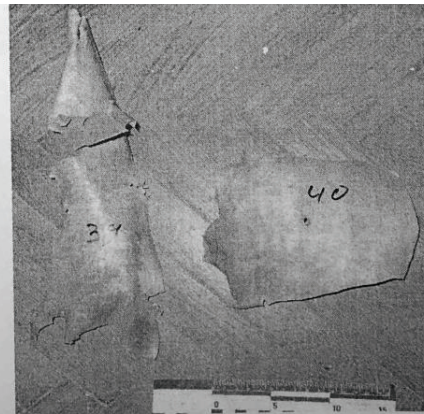

Illustration No. 33. Examination items Nos. 39-40

Experts

[signature]
[signature]

S. Zholak
I. Borozenets

SECURITY SERVICE OF UKRAINE
TABLE OF ILLUSTRATIONS
TO EXPERT OPINION No. 143 of 04.03.2015
№ 143 від 03.04.2015



Illustration No. 34. Examination items Nos. 41-45

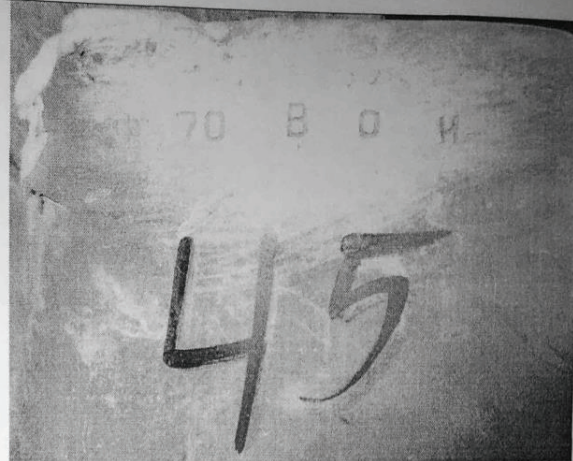

Illustration No. 35. Markings on examination item No. 45

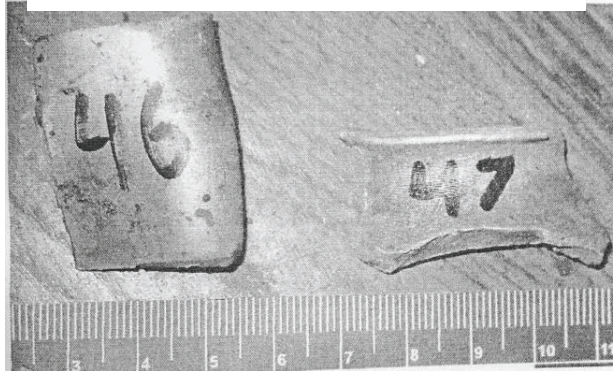

Illustration No. 36. Examination items Nos. 46-47



Illustration No. 37. Examination item No. 48

Experts

[signature]
[signature]

S. Zholak
I. Borozenets

SECURITY SERVICE OF UKRAINE
TABLE OF ILLUSTRATIONS
TO EXPERT OPINION No. 143 of 04.03.2015

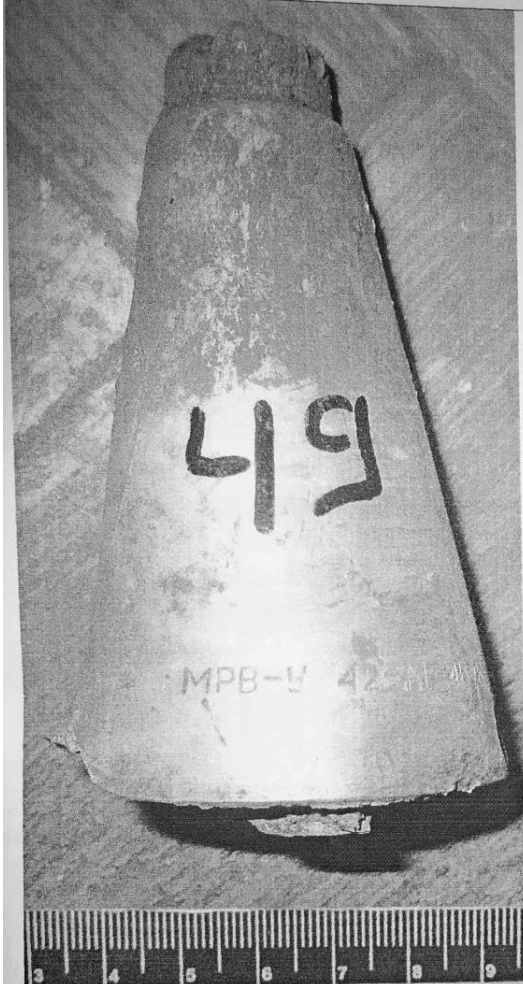

Illustration No. 38. Examination item No. 49



Illustration No. 39. Examination items Nos. 50, 51

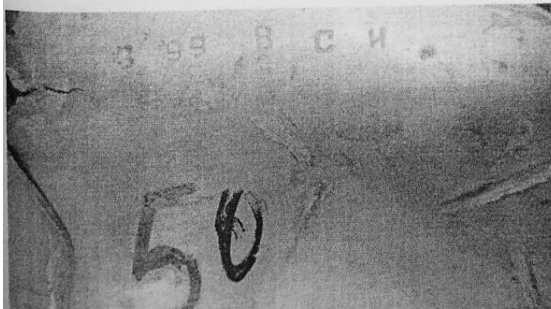

Illustration No. 40. Markings on examination item No. 50

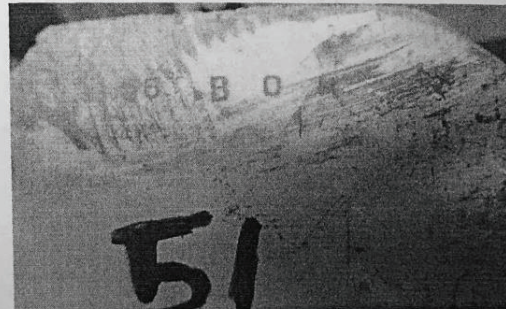

Illustration No. 41. Markings on examination item No. 51

Experts

[signature]

S. Zholak

[signature]

I. Borozenets

SECURITY SERVICE OF UKRAINE
TABLE OF ILLUSTRATIONS
TO EXPERT OPINION No. 143 of 04.03.2015

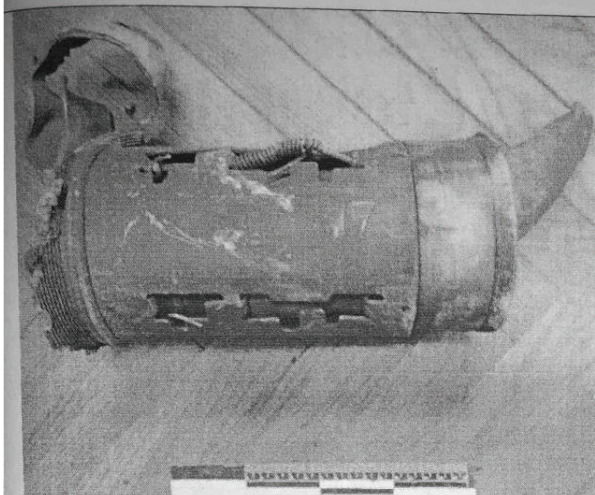

Illustration No. 42. Examination item No. 17

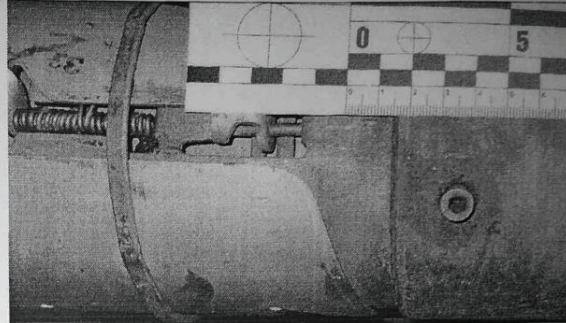
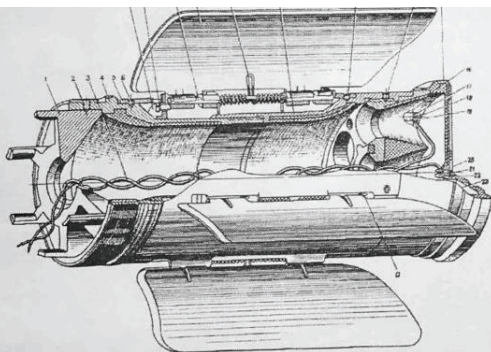

Illustration No. 43. Stabilizer block for M-21 OF shell (sample)



[illegible caption]

Illustration No. 44. Stabilizer block for M-21 OF shell

Experts

[signature]

S. Zholak

[signature]

I. Borozenets

SECURITY SERVICE OF UKRAINE
TABLE OF ILLUSTRATIONS
TO EXPERT OPINION No. 143 of 04.03.2015

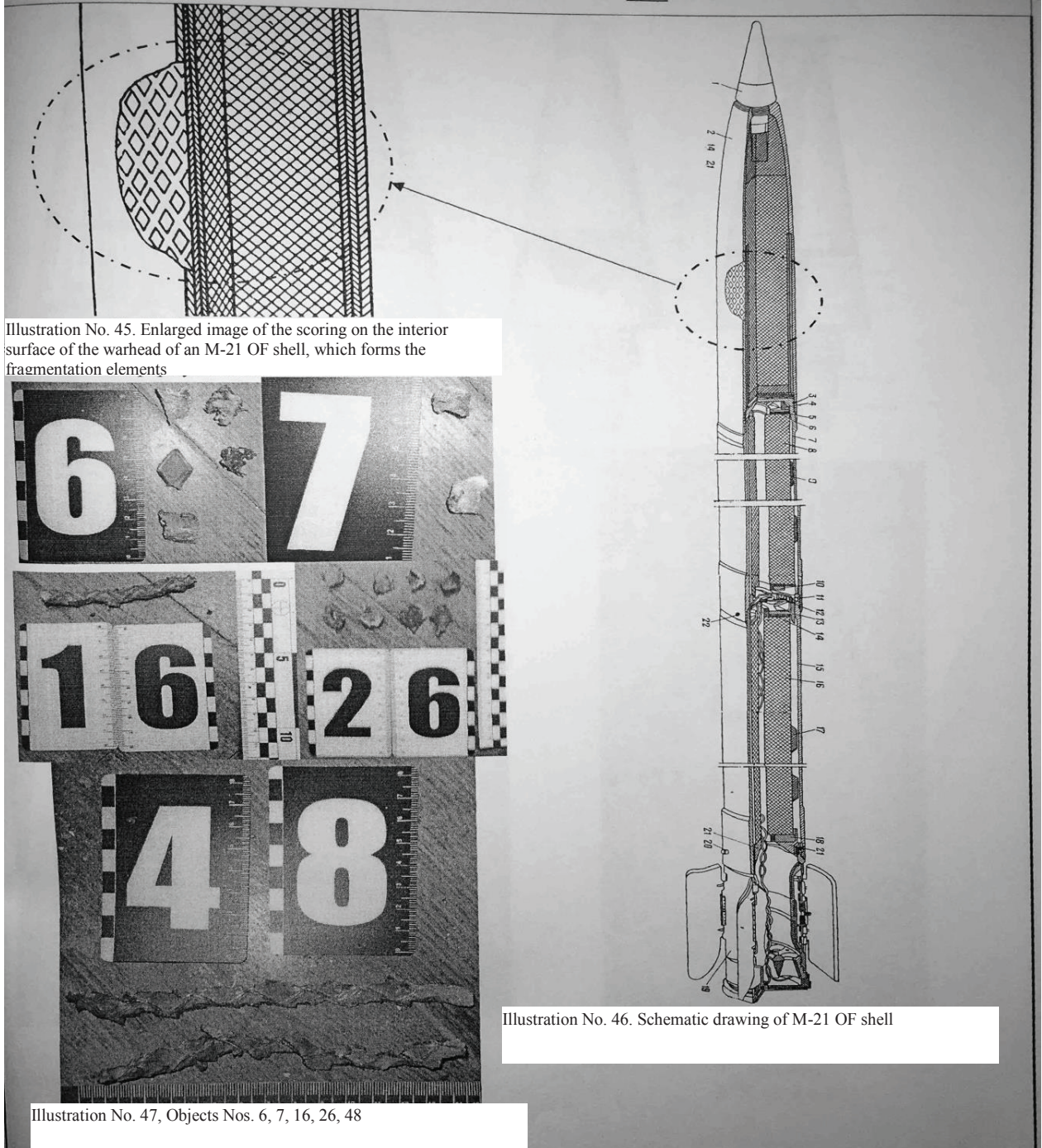

Illustration No. 45. Enlarged image of the scoring on the interior surface of the warhead of an M-21 OF shell, which forms the fragmentation elements

Illustration No. 46. Schematic drawing of M-21 OF shell

Illustration No. 47, Objects Nos. 6, 7, 16, 26, 48

Experts

[signature]
 [signature]

S. Zholak
 I. Boroznets

SECURITY SERVICE OF UKRAINE
TABLE OF ILLUSTRATIONS
TO EXPERT OPINION No. 143 of 04.03.2015

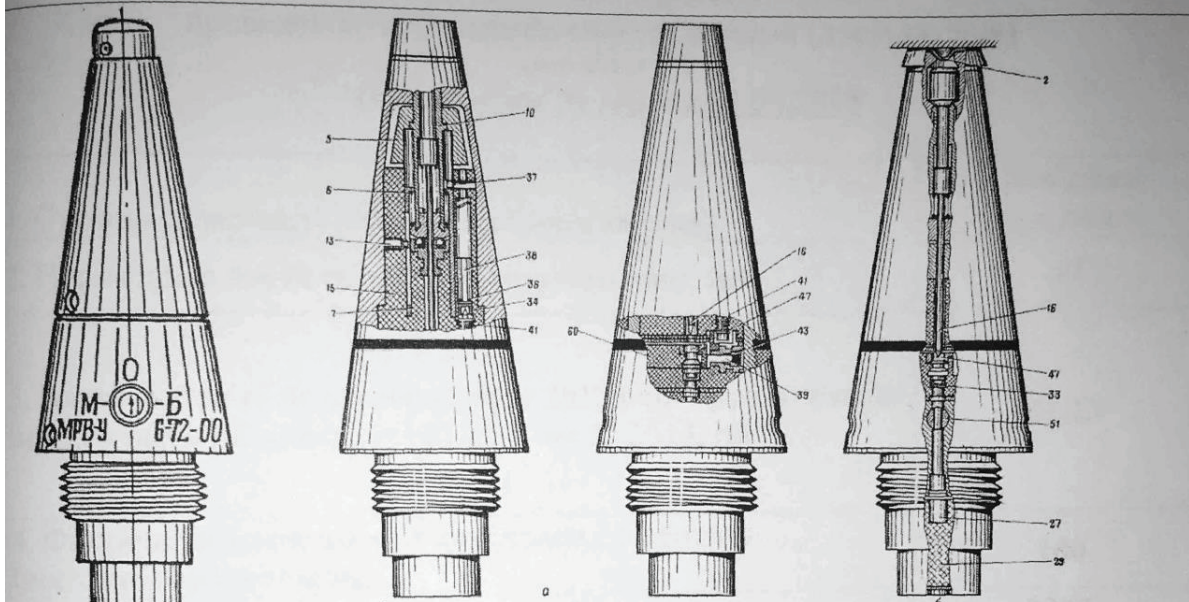

Illustration No. 48. General appearance and layout of MRV-U fuse



Illustration No. 49. Examination item No. 22

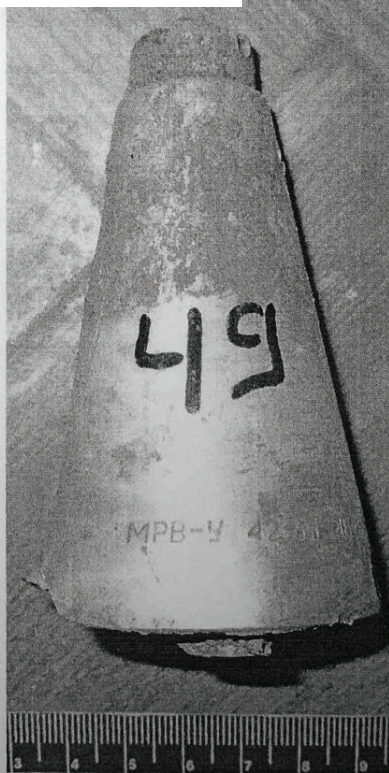

Illustration No. 50 Examination item No. 49

Experts

[signature]
 [signature]

S. Zholak
 I. Borozenets

Annex 118

Expert Opinion No. 532/2014, drafted by the Forensic Research Center, Ministry of Internal Affairs of Ukraine, Main Directorate of the Ministry of Internal Affairs of Ukraine in Kharkiv Region (3 April 2015)

This document has been translated from its original language into English, an official language of the Court, pursuant to Rules of the Court, Article 51.

Pursuant to Rules of the Court Article 51(3), Ukraine has translated only an extract of the original document constituting this Annex. In further compliance with this Rule, Ukraine has provided two certified copies of the full original-language document

MINISTRY OF INTERNAL AFFAIRS OF UKRAINE
MAIN DIRECTORATE OF THE MINISTRY OF INTERNAL AFFAIRS OF UKRAINE
IN KHARKIV REGION

FORENSIC RESEARCH CENTER

34 vul.Kovtuna, Kharkiv

Tel. (057)721-23-39

vvtptd_kharkov@ukr.net

EXPERT CONCLUSION

04.03.2015

Kharkiv

No. 532/2014

The forensic fire and explosives analysis department of the Forensic Research Center (FEAD FRC) at the Kharkiv Region Main Directorate of the Ministry of Internal Affairs of Ukraine received, on 11.11.2014, a resolution dated 11.10.2014 and issued by the senior forensic investigator, Senior Lieutenant of Justice I.M. Babak of the investigations department at the Kharkiv Regional directorate of the Security Service of Ukraine, as part of criminal proceedings No. 2201422000000305, accompanied by letter No. 70/6-3867nt of 11.10.2014 from the Kharkiv Regional Directorate of the Security Service of Ukraine, requesting a comprehensive forensic explosives analysis and analysis of explosive substances and products of explosion and gunfire according to expert specialism 5.1 (investigation of explosive substances and products of explosion and gunfire) and expert specialism 5.2 (investigation of explosive devices and the traces and circumstances of an explosion).

The task of forensic analysis has been assigned to the head of the fire forensics sector at FEAD FRC, Police Lieutenant-Colonel Dmytro Arkadiyovych Karakurkchi, who has a higher education degree in military engineering and is a qualified forensic expert certified to conduct forensic analysis according to expert specialism No. 5.1 (investigation of explosive devices and products of explosion and gunfire, certificate No. 11537 issued by the Expert Qualifications Commission of the Ministry of Internal Affairs of Ukraine on 11.29.2012) and a qualified forensic expert certified to conduct forensic explosives analysis according to expert specialism No. 5.2 (investigation of explosive devices and the traces and circumstances of an explosion, certificate No. 13089 issued by the Expert Qualifications Commission of the Ministry of Internal Affairs of Ukraine on 10.03.2014), employed as an expert since 2011.

I understand that a deliberately false conclusion or unjustified refusal to perform assigned duties is an offence under Articles 384 and 385 of the Penal Code of Ukraine.

[seal:] Forensic Research Center No. 12 Kharkiv Region Main
Directorate Ministry of Internal Affairs of Ukraine

[signature] **D.A. Karakurkchi**

[seal:] Forensic Research Center No. 12 Kharkiv Region
Main Directorate Ministry of Internal Affairs of Ukraine
Forensic expert [signature]

D.A. Karakurkchi

Background on the case (*known from the investigator's resolution to request a forensic analysis*):
“On 11.09.2014, around 9:38 p.m., the duty post received an alarm signal as a result of an explosion at the Stena café located at 13 vul. Rymarska, Kharkiv.”

The following was submitted for forensic analysis:

- Copy of the incident scene inspection report of 11.09.2014 compiled by Police Lieutenant M.V. Manzhulin, an investigator of the Dzerzhinsky district investigations department, Kharkiv city directorate of the Ministry of Internal Affairs Main Directorate in Kharkiv Region, 2 pages;
- Table illustrating the incident scene inspection report of 11.09.2014, 7 pages;
- Copy of the incident scene inspection report of 11.10.2014 compiled by Police Lieutenant (name illegible), an investigator of the Dzerzhinsky district investigations department, Kharkiv city directorate of the Ministry of Internal Affairs Main Directorate in Kharkiv Region, 3 pages;
- Copy of the incident scene inspection report of 11.10.2014 compiled by Police Lieutenant I.I. Shapovalov, an investigator of the Dzerzhinsky district investigations department, Kharkiv city directorate of the Ministry of Internal Affairs Main Directorate in Kharkiv Region, 2 pages;
- Copy of the incident scene inspection report of 11.10.2014 compiled by Police Senior Lieutenant S.Ye. Toporkov, an investigator of the Dzerzhinsky district investigations department, Kharkiv city directorate of the Ministry of Internal Affairs Main Directorate in Kharkiv Region, 2 pages;
- Copy of the incident scene inspection report of 11.10.2014 compiled by Police Captain M.M. Lukyanenko, an investigator of the Dzerzhinsky district investigations department, Kharkiv city directorate of the Ministry of Internal Affairs Main Directorate in Kharkiv Region, 2 pages;
- Copy of the incident scene inspection report of 11.10.2014 compiled by Police Lieutenant M.V. Manzhulin, an investigator of the Dzerzhinsky district investigations department, Kharkiv city directorate of the Ministry of Internal Affairs Main Directorate in Kharkiv Region, 3 pages;
- Objects retrieved during the incident scene inspection, in 25 packages.

The following questions were put to forensic analysis:

1. Do the objects found at the scene of the incident and submitted for investigation bear traces of explosive substances? If yes, which ones?
2. Was the explosion at the Stena café (13 vul. Rymarska, Kharkiv) around 9:38 p.m. on 11.09.2014 caused by an explosive device? If yes, what type of device is it? What make is this device: an IED or industrial?
3. What method of detonation was used in this instance?
4. If the explosion was caused by ammunition, what type is it (grenades, mines, shells etc.)?
5. Do the materials submitted for analysis contain any data pointing to the identifying characteristics of the person who made the explosive device (professional skills, knowledge of the manufacturing process and operation of explosive devices, etc)?

List of forensic analysis methods entered in the Register of Forensic Analysis Methods at the Ministry of Justice of Ukraine and used in this analysis:

1. Comprehensive investigation of explosive devices, explosive substances and traces of explosion (registration code 0.1.12)
2. General methodology of assigning and performing comprehensive forensic analyses conducted by a board of experts (registration code 0.1.16)
3. Explosive substance investigation (registration code 5.1.15)
4. Investigation of explosive substances and explosion products using chemical methods and thin-layer chromatography (registration code 5.1.23)

Environmental conditions were recorded in the department's environmental conditions journal QF.6-5.3-01.00.1 according to procedure QP.6-5.3-01 (conforming to the norms of GOST 12.1.005-88).

In the resolution requesting a comprehensive forensic explosives analysis and analysis of explosive substances and products of explosion and gunfire, the senior forensic investigator, Senior Lieutenant of Justice I.M. Babak of the investigations department at the Kharkiv Regional directorate of the Security Service of Ukraine gave permission to use destructive methods of investigation and to fully or partially destroy investigated objects.

INVESTIGATION [1-12]

The study and analysis of documents and illustrative material submitted for investigation [1, 2, 5-7, 10, 11]

The following documents were submitted for investigation:

- Copy of the incident scene inspection report of 11.09.2014 compiled by Police Lieutenant M.V. Manzhulin, an investigator of the Dzerzhinsky district investigations department, Kharkiv city directorate of the Ministry of Internal Affairs Main Directorate in Kharkiv Region, 2 pages;
- Table illustrating the incident scene inspection report of 11.09.2014, 7 pages;
- Copy of the incident scene inspection report of 11.10.2014 compiled by Police Lieutenant (name illegible), an investigator of the Dzerzhinsky district investigations department, Kharkiv city directorate of the Ministry of Internal Affairs Main Directorate in Kharkiv Region, 3 pages;
- Copy of the incident scene inspection report of 11.10.2014 compiled by Police Lieutenant I.I. Shapovalov, an investigator of the Dzerzhinsky district investigations department, Kharkiv city directorate of the Ministry of Internal Affairs Main Directorate in Kharkiv Region, 2 pages;
- Copy of the incident scene inspection report of 11.10.2014 compiled by Police Senior Lieutenant S.Ye. Toporkov, an investigator of the Dzerzhinsky district investigations department, Kharkiv city directorate of the Ministry of Internal Affairs Main Directorate in Kharkiv Region, 2 pages;
- Copy of the incident scene inspection report of 11.10.2014 compiled by Police Captain M.M. Lukyanenko, an investigator of the Dzerzhinsky district investigations department, Kharkiv city directorate of the Ministry of Internal Affairs Main Directorate in Kharkiv Region, 2 pages;

- Copy of the incident scene inspection report of 11.10.2014 compiled by Police Lieutenant M.V. Manzhulin, an investigator of the Dzerzhinsky district investigations department, Kharkiv city directorate of the Ministry of Internal Affairs Main Directorate in Kharkiv Region, 3 pages;

The following was established from the copy of an incident scene inspection report dated 11.09.2014 by Police Lieutenant M.V. Manzhulin, an investigator of the Dzerzhinsky district investigations department, Kharkiv city directorate of the Ministry of Internal Affairs Main Directorate in Kharkiv Region: *“The object of inspection is the building of the Stena pub located at 13 vul. Rymarska, Kharkiv. The area opposite the above pub is covered with shards of glass and plastic and metal fragments. Across the road, opposite the above pub is a building with the sign “Proconsul.” This paved area is cordoned off with tape. The asphalted road and pavements from the perimeter of building No. 13 along Rymarska Street to the building opposite are covered with broken glass. To the right of the entrance to the building with the sign “Proconsul,” on the roadside facing down, is a grey VAZ car showing broken glass; no mechanical damage to the car is found. On the asphalt next to the right side of the car are brown fragments (word illegible) VAZ 21-10 reg. No. AX7669CM. In front of and under the car there are 2 metal structures in the shape of a pipe, a large amount of glass and parts of a wooden floor. The right window is smashed and caved in. Next to the right back door handle there is a dent 10 cm in length and extensive damage to bodywork. Further along the road between the car and the pavement there are multiple shards of broken glass, parts of plastic structures and parts of metal structures. Next to building 13 in Rymarska Street is a Volkswagen Sharan car reg. region 01 900-09 KO. There is some damage to the bodywork on the right side of the car in the form of chipping, and the right side view mirror is snapped off. The mirror case has (illegible word) two, about 7 cm long and 3 cm wide. There is some broken glass on the car roof. Behind the car there is a metal fence separating the pavement and road. There are shards of glass on the metal fence, as well as rubber seals from PVC windows. On the pavement there are multiple shards of glass, bits of foam rubber, a soft toy and plastic parts of a PVC window. Opposite the corner of the building with the number 13 in Rymarska Street, behind the metal fence near the border on the right side of the asphalted road, there is a black metal plate which says Stena Bar. There are four windows at ground level. Window No. 1, measuring 120 x 120 cm, has no glazing and has a part of a PVC window at the bottom. Window No. 2, measuring 1.30 x 120 cm, has no glazing. No. 3, 90 x 100 cm, no glazing. No. 4, 90 x 110 cm, no glazing. There is a grey VAZ 2110 car on the pavement. There are multiple shards of glass. On the pavement in front of the house there are large shards of glass covered with mirror film. Between windows 2 and 3 there are shards of glass from the café’s advert. The window*

immediately next to the archway has a hole measuring 90 x 100 cm. There is a large piece of broken glass on the melted surface. A huge piece of glass measuring 100 x 70 cm. On the road next to the pavement there is a metal structure [illegible] in the form of a pipe and parts of a metal window. Next to the archway gate (word illegible) and by the entrance to the Proconsul office building, there are multiple shards of glass and window parts lying on the asphalt. To the left of the corner of building 13 in Rymarska Street is a courtyard entrance. On the pavement next to the entrance are brown stains that look like blood. On the left column next to the entrance, at about 150 cm above ground there are light brown stains that look like blood. On column No. 2, there are stains that look like blood. This concludes the inspection of the incident scene.”

The following was established from the copy of an incident scene inspection report dated 11.10.2014 by Police Lieutenant A.V. Buymytsky, an investigator of the Dzerzhinsky district investigations department, Kharkiv city directorate of the Ministry of Internal Affairs Main Directorate in Kharkiv Region: *“The scene of the incident is the Stena pub building located at 13 vul. Rymarska, Kharkiv. The scene of the incident is in the basement of a three-story building at the above address. The entrance to the building is on the left. The entrance is from the side of the building. Above the entrance there is a detachable plate with the sign “Stena.” The door is painted grey. On inspection, the door is found to be deformed in a wave-like pattern. The door’s external surface has a protrusion as a result of deformation. In the middle and bottom of the outer door surface, on the right edge of the door bar there is damage in the form of metal impression. Further inspection of the door has established that the top and bottom grey metal hinges are snapped off. At the fixing point (words illegible) ...The following damage was registered inside the building upon entering (words illegible) ...on the ceiling, at about 2 m high there is damage to thermal insulation. To the right of the building entrance (the rest of the sentence is illegible). There is a thick deposit of a grey substance that looks like soot on the outer surface of the bar, on the metal structures built into the bar and on the lateral surface of the room’s columns facing the bar. There are multiple track-style indentations on the surface of the bar in the direction away from the hole to the left side of the bar. The tracks have a radial trajectory from the hole to the bar. When removing fragments of the interior from the blast hole it was established that the surface under the floor is sand, and there is a distinct smell of ammonia in the vicinity of the hole. The interior behind the bar is destroyed. To the right of the bar is a 1.7 m tall refrigerator with the door missing.*

Inside the refrigerator there are many brown glass bottles with traces of soot and dust. On the left behind the refrigerator there is a doorway to the adjacent room which is entered via stairs. The door to the room was missing at the time of inspection, located 4 m away from the back entrance to the building. An inspection of the ceiling above the bar established that the insulating material, glass wool, bore traces of a grey substance.”

The following was established from the copy of an incident scene inspection report dated 11.10.2014 by Police Captain M.M. Lukyanenko, an investigator of the Dzerzhinsky district investigations department, Kharkiv city directorate of the Ministry of Internal Affairs Main Directorate in Kharkiv Region: *“during the additional inspection conducted in order to find components of a possible explosive device, the premises of the café at 13 vul. Rymarska, Kharkiv were divided into four imaginary zones, after which the debris, fragments and items of the interior were moved onto a platform located opposite the entrance and placed separately onto a surface covered with film and cotton sheets. After this, the removed items were thoroughly sorted, sifted and inspected, during which the following objects were found and retrieved: from the crater and the adjacent area (1.5 m radius): 1) fragments of fabric showing traces of charring and soot, with torn edges; 2) a 95 x 95 mm square metal object with traces of soot; 3) magnet fragments showing traces of soot; 4) metal fragments showing signs of deformation in the form of protrusions and ruptures; 5) pieces of a green fabric with a zipped pocket (unzipping the pocket reveals a piece of paper inside with a drawing in ballpoint and color pens and with letters and numbers written in ballpoint on the reverse). The following was retrieved from the stairs in the middle of the café: 6) Multiple metal fragments with elements of grooving which have soot on the surface.”*

The following was established from the copy of an incident scene inspection report dated 11.10.2014 by Police Lieutenant M.V. Manzhulin, an investigator of the Dzerzhinsky district investigations department, Kharkiv city directorate of the Ministry of Internal Affairs Main Directorate in Kharkiv Region: *“The object of the additional inspection is the building of the Stena bar located at 13 vul. Rymarska, Kharkiv. Entrance to the building is through the doorway in which the doors are open at the time of inspection. There is deformation to the door. There are bits of cardboard on the floor by the entrance. On entry through the doorway one can see Room No. 1. Entrance to the room is through (word illegible) down the stairs on which there are items made of green fabric. To the right of the stairs there are tables and chairs lying around in disarray. To the right of the entrance door there is a badly deformed wall. Hanging on the wall under the ceiling is a television set, which is badly deformed and damaged. It is not possible to see the TV set's make. To the right of the TV set, next to window No. 1 there is a white air conditioner showing serious damage.*

Window No. 1, measuring approximately 120 x 120 cm has no glazing. At the bottom of the window, there is a part from its white metal frame. Window No. 2, measuring 120x 130 cm, has no glazing. Opposite window No. 2 there is a heater showing signs of deformation. Window No. 3, measuring approximately 90 x 100 cm has no glazing. Opposite the window there is a black audio speaker and a maroon drum. Opposite the window, there are bits of wood and broken glass. On the wall between windows, three and 4 there is a black Yamaha audio speaker. Window No. 4 measuring 90 x 100 cm has no glazing. On the windowsill opposite the window there is a black electric device showing signs of mechanical damage. The wall with the window facing Rymarska Street is badly deformed. The wall to the left of the window is badly deformed. Opposite the wall, there is a music stand which has sustained mechanical damage. About 5 meters away from the window there is a doorway with no door. The room's walls show signs of serious deformation. On the floor, there are bits of concrete, wood and plastic. About 2 meters away from the doorway is another doorway with a metal and plastic doorframe, but the internal door is missing. On the floor through the doorway, there are bits of plastic, while the ceiling and walls behind the doorway are deformed. Through the corridor, one can see the passage to the restroom, which is covered by a green plastic tile. To the left of the doorway is another doorway with the door missing. There are bits of wood and plastic on the floor of this passage. There are signs of deformation to the walls and ceiling. To the left of the doorway is a bar on which one can see bits of wood and plastic, glasses and fragments, as well as a black electric device. The bar is badly deformed. Behind the bar, there are bits of wood, plastic and wood frame, with broken glass on top. Opposite the bar at the rear of the building, there is a doorway with the door missing. On the floor behind the doorway, there are items and bits of wood and plastic. Straight on from this doorway is another doorway behind which there are tiled stairs going up. In the room, across from the middle of the bar, there is a crater about 30 cm deep and 50 cm in diameter. The crater is 20 cm long at its deepest and is covered with rocks, and one can see bits of rebar. On the floor around the crater, about 20-30 cm away from the edge, there are black footprints. The soil inside the crater is brown and, in parts, black. Next to the musical instruments, there is a brown lady's handbag with mechanical damage. Next to the handbag, there is a Ukrainian citizen's passport in the name of Olga Yuryevna Vitushnyak, DOB 08.20.1992. In the epicenter of the blast, inside the bar, there is a Zip bag containing bandage with fluid residue. This concludes the inspection of the incident scene."

Therefore, based on the circumstances and specifics of the incident scene described in the incident scene inspection reports, it is possible to conclude that the premises of the Stena bar at 13 vul. Rymarska, Kharkiv shows damage typical of the brisance, incendiary, thermal and fragmentation effects of explosive action. The center of the blast is the floor surface next to the bar.

The absence of items in the said building capable of causing a physical explosion (canisters with compressed gas or air, paint cans, steam boilers, etc) as well as the size of the crater, the nature of damage and the appearance of soot make it possible to conclude that an explosive device has been detonated, carrying an explosive charge with a negative oxygen balance and with the power of about 1-1.2 kg in the trotyl (TNT) equivalent.

Inspection and opening of sealed bags, preliminary appearance of investigated objects [1-3, 5-11]

The objects were delivered for investigation sealed in 25 packages: packages No. 1-25.

Packages No. 1-7 and 10-17 are the standard polymeric bags of the Ministry of Internal Affairs of Ukraine Expert Service duly sealed along the adhesive line (Figures 1-25 of the illustrative table appended to the expert conclusion). On the front of each bag, there is writing and signatures in longhand using blue ink:

- **package 1** (Ministry of Internal Affairs of Ukraine Expert Service bag No. 1784474):

Ministry of Internal Affairs of Ukraine Directorate in Kharkiv Region city, district Dzerzhinsky district Description: Inspection of the incident scene at 13 vul. Rymarska, Kharkiv, café Stena Found: cloth fragment investigator: _____ witnesses: 1 (signature) 2 (signature) specialist: (signature) Ye.A. (Surname illegible) date sealed: 11.09.14. Crime reporting journal entry No. _____ 20____ (Figure 1 of the illustrative table appended to the expert conclusion).

- **package 2** (Ministry of Internal Affairs of Ukraine Expert Service bag No. 1451806):

Ministry of Internal Affairs of Ukraine Directorate in _____ city, district _____ Description: Inspection of the incident scene at the Stena rock pub café at vul. Rymarska, Kharkiv found: wallet showing effect of high-temperature action investigator: _____ witnesses: 1 (signature) 2 (signature) specialist: (signature) M.A. Mayer date sealed: 11.09.14. Crime reporting journal entry No. _____ 20____ (Figure 2 of the illustrative table appended to the expert conclusion).

- **package 3** (Ministry of Internal Affairs of Ukraine Expert Service bag No. 0508138):

Ministry of Internal Affairs of Ukraine Directorate in _____ city, district Dzerzhinsky Description: Inspection of the incident scene at the Stena rock pub café at vul. Rymarska, Kharkiv found: fragments of bank notes showing effect of high-temperature action investigator: _____ witnesses: 1 (signature) 2 (signature) specialist: (signature) M.A. Mayer date sealed: 11.09.14. Crime reporting journal entry No. _____ 20____ (Figure 3 of the illustrative table appended to the expert conclusion).

- **package 4** (Ministry of Internal Affairs of Ukraine Expert Service bag No. 1784473):

Ministry of Internal Affairs of Ukraine Directorate in Kharkiv Region city, district Dzerzhinsky district department Description: Inspection of the incident scene at 13 vul. Rymarska, Kharkiv, café Stena found: laptop investigator: _____ witnesses: 1 (signature) 2 (signature) specialist: (signature) Ye.A. (signature illegible) date sealed: 11.09.14. Crime reporting journal entry No. _____ 20__ (Figure 4 of the illustrative table appended to the expert conclusion).

- **package 5** (Ministry of Internal Affairs of Ukraine Expert Service bag No. 1784476):

Ministry of Internal Affairs of Ukraine Directorate in _____ city, district Dzerzhinsky Description: Inspection of the incident scene at the Stena rock pub café at vul. Rymarska, Kharkiv found: advertising flyers investigator: _____ witnesses: 1 (signature) 2 (signature) specialist: (signature) M.A. Mayer date sealed: 11.09.14. Crime reporting journal entry No. _____ 20__ (Figure 5 of the illustrative table appended to the expert conclusion).

- **package 6** (Ministry of Internal Affairs of Ukraine Expert Service bag No. 1968523):

Ministry of Internal Affairs of Ukraine Directorate in _____ city, district Dzerzhinsky Description: Inspection of the incident scene at the Stena rock pub café at vul. Rymarska, Kharkiv found: 3 laptops – 2 chargers investigator: _____ witnesses: 1 (signature) 2 (signature) specialist: (signature) M.A. Mayer date sealed: 11.09.14. Crime reporting journal entry No. _____ 20__ (Figure 6 of the illustrative table appended to the expert conclusion).

- **package 7** (Ministry of Internal Affairs of Ukraine Expert Service bag No. 1968085):

Ministry of Internal Affairs of Ukraine Directorate in _____ city, district Dzerzhinsky Description: Inspection of the incident scene at the Stena rock pub café at vul. Rymarska, Kharkiv found: advertising flyers investigator: _____ witnesses: 1 (signature) 2 (signature) specialist: (signature) M.A. Mayer date sealed: 11.09.14. Crime reporting journal entry No. _____ 20__ (Figure 7 of the illustrative table appended to the expert conclusion).

- **package 10** (Ministry of Internal Affairs of Ukraine Expert Service bag No. 0509977):

Ministry of Internal Affairs of Ukraine Directorate in _____ city, district _____ Description: Inspection of the incident scene after explosion at the Stena pub found: fluid residue from the inner surface of the bar investigator: _____ witnesses: 1 (signature) 2 (signature) specialist: (signature) date sealed: 11.10.14. Crime reporting journal entry No. _____ 20__ (Figure 10 of the illustrative table appended to the expert conclusion).

- **package 11** (Ministry of Internal Affairs of Ukraine Expert Service bag No. 0509968):

Ministry of Internal Affairs of Ukraine Directorate in _____ city, district _____ Description: Inspection of the incident scene after explosion at the Stena pub found: fragment of cloth with pocket containing a sheet of paper investigator: _____ witnesses: 1 (signature) 2 (signature) specialist: (signature) date sealed: 11.10.14. Crime reporting journal entry No. _____ 20__ (Figure 11 of the illustrative table appended to the expert conclusion).

- **package 12** (Ministry of Internal Affairs of Ukraine Expert Service bag No. 0509969):

Ministry of Internal Affairs of Ukraine Directorate in _____ city, district _____ Description: Inspection of the incident scene after explosion at the Stena pub found: magnet fragments investigator: _____ witnesses: 1 (signature) 2 (signature) specialist: (signature) date sealed: 11.10.14. Crime reporting journal entry No. _____ 20__ (Figure 12 of the illustrative table appended to the expert conclusion).

- **package 13** (Ministry of Internal Affairs of Ukraine Expert Service bag No. 0509979):

Ministry of Internal Affairs of Ukraine Directorate in _____ city, district _____
Description: Inspection of the incident scene after explosion at the Stena pub found: metal fragments with grooving investigator: _____ witnesses: 1 (signature) 2 (signature) specialist: (signature) date sealed: 11.10.14. Crime reporting journal entry No. _____ 20____ (Figure 13 of the illustrative table appended to the expert conclusion).

- **package 14** (Ministry of Internal Affairs of Ukraine Expert Service bag No. 1158952):

Ministry of Internal Affairs of Ukraine Directorate in _____ city, district _____
Description: Inspection of the incident scene after explosion at the Stena pub found: fabric fragments investigator: _____ witnesses: 1 (signature) 2 (signature) specialist: (signature) date sealed: 11.10.14. Crime reporting journal entry No. _____ 20____ (Figure 14 of the illustrative table appended to the expert conclusion).

- **package 15** (Ministry of Internal Affairs of Ukraine Expert Service bag No. 1158955):

Ministry of Internal Affairs of Ukraine Directorate in _____ city, district _____
Description: Inspection of the incident scene after explosion at the Stena pub found: square metal fragment investigator: _____ witnesses: 1 (signature) 2 (signature) specialist: (signature) date sealed: 11.10.14. Crime reporting journal entry No. _____ 20____ (Figure 15 of the illustrative table appended to the expert conclusion).

- **package 16** (Ministry of Internal Affairs of Ukraine Expert Service bag No. 1158953):

Ministry of Internal Affairs of Ukraine Directorate in _____ city, district _____
Description: Inspection of the incident scene after explosion at the Stena pub found: metal fragments investigator: _____ witnesses: 1 (signature) 2 (signature) specialist: (signature) date sealed: 11.10.14. Crime reporting journal entry No. _____ 20____ (Figure 16 of the illustrative table appended to the expert conclusion).

- **package 17** (Ministry of Internal Affairs of Ukraine Expert Service bag No. 0508137):

Ministry of Internal Affairs of Ukraine Directorate in _____ city, district Dzerzhinsky
Description: Inspection of the incident scene at the Stena rock pub café at vul. Rymarska, Kharkiv found: red and black flag investigator: _____ witnesses: 1 (signature) 2 (signature) specialist: (signature) M.A. Mayer date sealed: 11.09.14. Crime reporting journal entry No. _____ 20____ (Figure 17 of the illustrative table appended to the expert conclusion).

- **Package No. 8** is a white quadrangular paper envelope measuring 155 x 113 (Figure 8 of the illustrative table appended to the expert conclusion). On the front of the envelope there are inscriptions:

- in black print at the top left corner: "Sender address, post code," followed by five dotted lines; at the bottom right corner: "Recipient address," followed by six dotted lines.

- In blue ink handwriting: "11.09.14 Inspection of the incident scene at the Stena rock pub café at 13 vul. Rymarska, Kharkiv: cylindrical metal fragment. Witnesses: 1. (signature) 2. (signature) Specialist: (signature) M.A. Mayer. Investigator:"

On the back, there are inscriptions in black print and a bar code.

- **Package No. 9** is a cylindrical container made of clear colorless glass 30 mm in diameter and 60 mm in height (Figure 9 of the illustrative table appended to the expert conclusion). The top of the container is sealed with a grey rubber cap.

There is a white piece of paper – label – affixed to the side of the container with clear polymeric adhesive tape (scotch tape). The label bears inscriptions handwritten in blue ink: “*Incident scene inspection at 13 vul. R. Rollana, Kharkiv. Witnesses: 1. (signature) 2. (signature) Participant: (signature) A.S. Matyan Investigations department investigator (signature)*”

- **Package No. 18** is a partially transparent dark grey polymeric bag tied with a piece of white string at the neck (Figure 18 of the illustrative table appended to the expert conclusion). The ends of the string are attached to a rectangular piece of white paper additionally covered with clear polymeric adhesive tape (scotch tape), the label. The label bears handwritten inscriptions and signatures in blue ink: “*Incident scene inspection at 13 vul. Romena Rollana, Kharkiv. Witnesses: 1. (signature) 2. (signature) Participants: 1. (signature) 2. (signature) Investigator (signature) Toporkov*”

- **Package No. 19** is a semi-transparent blue polymeric bag tied with a piece of white string at the neck (Figure 19 of the illustrative table appended to the expert conclusion). The ends of the string are attached to a rectangular piece of white paper, the label. The label bears handwritten inscriptions in blue ink: “*personal effects given up voluntarily by A.L. Kiseleva.*” The label also bears the blue round seal of the Dzerzhinsky district investigations department, No. 08804175.

- **Package No. 20** is a semi-transparent blue polymeric bag tied with a piece of white string at the neck (Figure 20 of the illustrative table appended to the expert conclusion). The ends of the string are attached to a rectangular piece of white paper, the label. The label contains handwritten explanatory notes in blue ink: “*personal effects given up voluntarily by A.L. Kiseleva.*” The label also bears the blue round seal of the Dzerzhinsky district investigations department, No. 08804175.

- **Package No. 21** is a semi-transparent blue polymeric bag tied with a piece of white string at the neck (Figure 21 of the illustrative table appended to the expert conclusion). The ends of the string are attached to a rectangular piece of white paper, the label. The label contains handwritten explanatory notes in blue ink: “*personal effects given up voluntarily by V.V.Svyatash.*” The label also bears the blue round seal of the Dzerzhinsky district investigations department, No. 08804175.

- **Package No. 22** is a semi-transparent blue polymeric bag tied with a piece of white string at the neck (Figure 22 of the illustrative table appended to the expert conclusion). The ends of the string are attached to a rectangular piece of white paper, the label. The label contains handwritten explanatory notes in blue ink: “*personal effects given up voluntarily by R.V. Maslov.*” The label also bears the blue round seal of the Dzerzhinsky district investigations department, No. 08804175.

- **Package No. 23** is a semi-transparent blue polymeric bag tied with a piece of white string at the neck (Figure 23 of the illustrative table appended to the expert conclusion). The ends of the string are attached to a rectangular piece of white paper, the label. The label contains handwritten explanatory notes in blue ink: *“personal effects given up voluntarily by V.V.Svyatash.”* The label also bears the blue round seal of the Dzerzhinsky district investigations department, No. 08804175.

- **Package No. 24** is a semi-transparent blue polymeric bag tied with a piece of white string at the neck (Figure 24 of the illustrative table appended to the expert conclusion). The ends of the string are attached to a rectangular piece of white paper, the label. The label contains handwritten explanatory notes in blue ink: *“personal effects given up voluntarily by R.V. Maslov.”* The label also bears the blue round seal of the Dzerzhinsky district investigations department, No. 08804175.

- **Package No. 25** is a semi-transparent blue polymeric bag tied with a piece of white string at the neck (Figure 25 of the illustrative table appended to the expert conclusion). The ends of the string are attached to a rectangular piece of white paper, the label. The label contains handwritten explanatory notes in blue ink: *“seized during inspection on 11.10.14 at 3-A vul. Balakireva, Kharkiv. Witnesses: 1. (signature) 2. (signature) Investigator (signature).”* The label also bears the blue round seal of the Dzerzhinsky district investigations department, No. 08804175.

The packages have not been disturbed, providing safe storage for the investigated objects and preventing unauthorized access.

The following was retrieved from the packages upon opening:

- **package No. 1:** fragment of clothes fabric with pocket opening - investigated object No. 1 (Figure 26 of the illustrative table appended to the expert conclusion);
- **package No. 2:** a damaged wallet with remnants of wire - investigated object No. 2 (Figure 27 of the illustrative table appended to the expert conclusion);
- **package No. 3:** bank notes (hryvnia) in a damaged (charred) condition - investigated object No. 3 (Figure 33 of the illustrative table appended to the expert conclusion);
- **package No. 4:** a Lenovo laptop - investigated object No. 4 (Figures 34, 35 of the illustrative table appended to the expert conclusion);

- **package No. 5:** four rectangular emblems and four shield-shaped emblems – group of investigated objects No. 5 (Figure 36 of the illustrative table appended to the expert conclusion);
- **package No. 6:** three laptops and two chargers – group of investigated objects No. 6 (Figures 37- 45 of the illustrative table appended to the expert conclusion);
- **package No. 7:** a short blue synthetic jacket with zip fastening - investigated object No. 7 (Figure 46 of the illustrative table appended to the expert conclusion);
- **package No. 8:** a cylindrical metal item of complex design - investigated object No. 8 (Figures 47 – 49 of the illustrative table appended to the expert conclusion);
- **package No. 9:** one metal fragment - investigated object No. 9 (Figure 50 of the illustrative table appended to the expert conclusion);
- **package No. 10:** a gauze pad with dark fluid residue - investigated object No. 10 (Figure 51 of the illustrative table appended to the expert conclusion);
- **from package No. 11:** a piece of pale-green fabric with a pocket - investigated object No. 11 (Figure 52 of the illustrative table appended to the expert conclusion);
- **package No. 12:** seven black metal fragments with the properties of a permanent magnet - investigated object No. 12 (Figure 53 of the illustrative table appended to the expert conclusion);
- **package No. 13:** pale-grey metal fragments – group of investigated objects No. 13 (Figures 54 - 61 of the illustrative table appended to the expert conclusion);
- **package No. 14:** fragments (torn pieces) of different types of stained and damaged fabric - investigated object No. 14 (Figure 62 of the illustrative table appended to the expert conclusion);
- **package No. 15:** a quadrangular metal plate - investigated object No. 14 (Figure 63 of the illustrative table appended to the expert conclusion);
- **package No. 16:** metal fragments (debris) with damage and fragments (torn pieces) of fabric – group of investigated objects No. 16 (Figures 64 - 68 of the illustrative table appended to the expert conclusion);
- **package No. 17:** a red-and-black flag - investigated object No. 17 (Figure 69 of the illustrative table appended to the expert conclusion);
- **package No. 18:** a scarf and a man’s tracksuit top – group of investigated objects No. 18 (Figure 70 of the illustrative table appended to the expert conclusion);
- **package No. 19:** a pair of black ladies’ ankle boots – group of investigated objects No. 19 (Figure 71 of the illustrative table appended to the expert conclusion);

- **package No. 20:** a black ladies' knitted top - investigated object No. 20 (Figure 72 of the illustrative table appended to the expert conclusion);
- **package No. 21:** a black and brown ladies' handbag - investigated object No. 21 (Figure 73 of the illustrative table appended to the expert conclusion);
- **package No. 22:** a white plastic bag with a pair of men's shoes, socks and belt - investigated object No. 22 (Figure 74 of the illustrative table appended to the expert conclusion);
- **package No. 23:** a pair of blue jeans - investigated object No. 23 (Figure 75 of the illustrative table appended to the expert conclusion);
- **package No. 24:** a pair of blue jeans, a white short-sleeve T-shirt and a grey jumper – group of investigated objects No. 24 (Figures 76, 77 of the illustrative table appended to the expert conclusion);
- **package No. 25:** a gauze pad - investigated object No. 25 (Figure 78 of the illustrative table appended to the expert conclusion);

The objects submitted for investigation correspond to their description in the resolution requesting forensic analysis.

Separate investigation of submitted objects [1 – 12]

An inspection of **investigated objects No. 1, 4 – 7, 17, 18, 20, and 23** established the following:

- there is no damage to the surface of these objects typical of explosive effects (brisant, incendiary and thermal action);
- there are no metal, plastic, stone or other items among these investigated objects that may be related or be part of an explosive device;
- on the surface of the investigated objects there are different types of deposits which may contain blast products; samples were collected from all the objects for a chemical investigation (of explosive substances and blast and gunfire products) by sprinkling, scrapings and swabbing (wiping with special gauze pads dabbed in acetone);

An inspection of **investigated objects No. 19, 21, 22, and 24** established the following:

- the outer surface contains mechanical damage (contact, impact, fragmentation) as well as deposits of a white-grey and dark grey substance.
- there are no metal, plastic, stone or other items among these investigated objects that may be related or be part of an explosive device;
- on the surface of the investigated objects there are different types of deposits which may contain blast products; samples were collected from all the objects for a chemical investigation (of explosive substances and blast and gunfire products) by sprinkling, scrapings and swabbing (wiping with special gauze pads dabbed in acetone);

Investigated object No. 2 is a leather wallet with popper fastening. The surface of the wallet has sustained substantial damage of a thermal nature: partial burning of the material (leather), charring, melting, plastic deformation under the impact of high temperature; the wallet doesn't open along the folds as a result of material sticking (fused) together. On the surface of the wallet there are burnt fragments of brown metal wires stuck together (not responsive to a permanent magnetic field) with remnants of plastic insulation, a 3.5 TRS type of coaxial electric contact (connector) is fixed to the ends of the wires (for audio signal transmission, probably for headphones or telephone accessories). Opening the wallet along the folds (using a paper knife) established that the wallet contains business cards, bankcards and promotional postcards. No other items or fragments were found that could be related to an explosive device.

Group of investigated objects No. 3 amounts to paper bank notes (Ukrainian hryvnia). Most of the notes have burnt edges; each note surface has dark grey and black deposits of varying thickness.

Investigated object No. 8 is a light-grey cylindrical object of complex design made of metal (not responsive to a permanent magnetic field). Dimensions: length: 50.5 mm, maximum diameter: 30.5 mm, mass: 38 grams. The surface of the investigated object has damage typical of an explosive effect: displacement, plastic deformation, cracking, fissure, thinning along the edges and roughness (typical of viscous rupture). The investigated object can be taken apart to three components:

- a part shaped like a 20 mm cylindrical cap, a smaller, 22 mm external diameter (of the casing) and a 17 mm internal diameter – the cap. The bottom section has a circular protrusion 26 mm in diameter and 3.3 mm in height, the outer lateral surface shows parallel longitudinal grooves of industrial origin, the inner surface shows grooving on the right side 17 mm in diameter. Inside the cap, on the bottom, there is a black deposit similar in appearance to soot.

- A cylindrical part of complex configuration, 38 mm long with the maximum diameter of 26.5 mm – bushing. The part has the following characteristic structural features:

- Two criss-cross slots located at a right angle to each other, in the top section – to fit a metal element and cutter;
- External grooving in the top section 17 mm in diameter – to fit the cap;
- External grooving in the bottom section 14 mm in diameter – to fit a grooved bushing;

- A rectangular 6 x 3 mm through opening – to fit a safety catch;
- An opening along the line of symmetry 7.5 mm in diameter (to fit a firing pin and spring);
- A cylindrical part of complex configuration 24 mm in length with the maximum diameter of 30.5 mm – a grooved bushing with the fragment of a casing inside. This part has the following characteristic structural features:
 - A protrusion in the upper section of the part in the shape of a congruent hexagon (key slot) with the side length of 15 mm and the maximum size (distance between two opposite angles) 30.5 mm
 - External grooving 24.5 mm in diameter (to fit a bushing in mine casing);
 - A metal washer (seal)
 - A circular protrusion in the bottom section 23 mm in diameter and 2.2 mm in height;
 - A longitudinal through opening 13.5 mm in diameter (to fit a firing pin and spring);

The outer and inner surfaces of the parts show black deposits similar in appearance to soot, with the deposits on the inner surface of the investigated object visibly thicker than those on the outer surface.

Investigated object No. 9 is an 11 x 9 mm irregularly shaped grey metal fragment (not responsive to a permanent magnetic field) weighing less than 1 gram. The surface and edges of the investigated object show damage characteristic of an explosive effect: displacement, plastic deformation, cracking, fissure, thinning along the edges and roughness (typical of viscous rupture). The surface of the investigated object shows signs of industrial treatment: remnants of parallel longitudinal grooves and a groove section with a right-angled crossing.

Investigated object No. 10 is a white gauze pad with a grey and white deposit.

Investigated object No. 11 is a piece of a white and grey synthetic fabric with a fragment of a black shoelace with a plastic catch. The investigated object shows damage in the form of torn fabric, a ragged edge with fraying and poorly visible melting, which may point to the brisant and thermal effects of detonating an explosive substance.

Group of investigated objects No. 12 amounts to seven black metal fragments having properties of a permanent magnet. The fragments have an irregular shape, and the surface and edges of the fragments show damage characteristic of an explosive effect: displacement, plastic deformation, cracking, fissure, thinning along the edges and roughness (typical of viscous rupture).

The surface of the investigated object retains sections of industrial origin, with a smooth surface showing signs of industrial treatment, and visible black deposits that look like soot.

Group of investigated objects No. 13 amounts to metal fragments with the total mass of 7 grams (Figures 55-61 of the illustrative table appended to the expert conclusion). All the fragments show damage such as displacement and plastic deformation, as well as an uneven surface showing features of deformation like cracking, fissure, thinning along the edges and roughness (typical of viscous rupture), some fragments have poorly visible sections with changing color. The surface of these investigated objects show grey and black deposits that look like soot.

After an initial visual inspection, the objects were divided into the following groups according to their established structural and morphological features:

– **group of investigated objects 13.1:** nine irregularly shaped metal fragments (not responsive to a permanent magnetic field) having distinct external (protruding) and internal (concave) sides displaying features of industrial origin:

- on the outer side: parallel transverse grooves (traces of mechanical treatment) about 0.1 mm wide, with some fragments showing 6-7 mm wide right-angled indentations with remnants of bevels.

- on the inner side: remnants of grooving and, apart from the abovementioned deformations, damage of a thermal nature: microsections with traces of melting (visible under a microscope).

– **investigated object No. 13.2:** a flattened cylindrical metal fragment (responsive to a permanent magnetic field) 6 mm in diameter and 9 mm long, the lateral side of which shows characteristic features of industrial origin: a fragment of external grooving. Inside the grooves there are visible beige and brown deposits.

– **group of investigated objects No. 13.3:** three metal fragments (not responsive to a permanent magnetic field) having distinct external (protruding) and internal (concave) sides; the external side shows characteristic features of industrial origin - parallel transverse grooves (traces of mechanical treatment) about 0.1 mm wide. Apart from the abovementioned deformations, group No. 13.3 objects show visible damage of a thermal nature: microsections with traces of melting (visible under a microscope).

– **investigated object No. 13.4** is a black metal fragment having properties of a permanent magnet. The fragment has an irregular shape, and its surface and edges show damage characteristic of an explosive effect: displacement, plastic deformation, cracking, fissure, thinning along the edges and roughness (typical of viscous rupture). The surface of the investigated object retains sections of industrial origin, with a smooth surface showing traces of industrial treatment and visible black deposits that look like soot.

– **group of investigated objects No. 13.5** is two metal fragments (responsive to a permanent magnetic field) in the form of fragments of a cylindrically coiled spring about 0.1 mm in diameter.

Group of investigated objects No. 14 amounts to pieces of various type fabric. All the objects in this group show damage in the form of torn fabric, ragged edges with fraying and poorly visible melting, which may point to the brisant and thermal effects of detonating an explosive substance. On the surface of the investigated objects there are thick deposits of dark grey, white, brown and black substances with varying degrees of dispersion.

Investigated object No. 15 is a metal plate fragment mm thick of a rectangular (nearly square) shape, measuring 94 x 95 mm with a mass of 180 grams. In the center of the investigated object there is a through hole 44 mm in diameter, and at the distance of 9 mm from the object's outer faces there are three through holes 6 mm in diameter. The object shows displacement and plastic deformation, as well as an uneven surface showing damage of mechanical origin (impact, contact) as well as roughness (typical of viscous rupture). The surface shows extensive grey and black soot-like deposits.

Group of investigated objects No. 16 amounts to metal fragments with the total mass of 208 grams (Figures 64 – 68 of the illustrative table appended to the expert conclusion) bits of torn black fabric with the mass of 4 grams.

All the metal fragments show displacement and plastic deformation, as well as an uneven surface showing features of deformation like cracking, fissure, thinning along the edges and roughness (typical of viscous rupture), some fragments have poorly visible sections of changing color and damage of mechanical (impact, contact) origin. On the surface of the fragments there are grey and black soot-like deposits as well as reddish-brown and ginger-colored deposits resembling products of ferrum-based alloy corrosion (rust).

After an initial visual inspection, the objects were divided into the following groups according to their established structural and morphological features:

– **group of investigated objects No. 16.1:** thirteen metal plate fragments (responsive to a permanent magnetic field) with the maximum thickness of 2 mm having distinct external (protruding) and internal (concave) sides displaying features of industrial origin, such as remnants of rivets and corresponding holes arranged in a certain way, edges retaining a regularly shaped configuration of industrial origin and (on the outer surface of some fragments) fragments of grey paintwork.

On the inner side, apart from the abovementioned general deformation, there is damage of thermal origin: microsections with traces of melting (visible under a microscope).

– **investigated object No. 16.2** is a 0.5 mm thick irregularly shaped metal plate fragment (not responsive to a permanent magnetic field) measuring 16.5 x 8.5 mm, with a mass of less than 1 gram. The object shows displacement and plastic deformation, as well as an uneven surface showing damage of mechanical origin (impact, contact) and roughness (typical of viscous rupture). On the outer side there are parallel transverse grooves (traces of mechanical treatment) about 0.1 mm wide. On the surface, there are grey and black soot-like deposits.

– **investigated object No. 16.3** is a flattened cylindrical metal fragment (responsive to a permanent magnetic field) 6 mm in diameter and 12 mm in length, the lateral surface of which has the characteristic features of industrial origin: external grooving. Inside the grooves there are visible reddish-brown deposits resembling products of ferrum-based alloy corrosion (rust).

– **investigated object No. 16.4** is an irregularly shaped metal fragment (not responsive to a permanent magnetic field) measuring 7.5 x 5.5 mm with a mass of less than 1 gram. The object shows displacement and plastic deformation, as well as an uneven surface showing damage of mechanical origin (impact, contact) and roughness (typical of viscous rupture). On the surface, there are grey and black soot-like deposits.

– **investigated object No. 16.5** is a black metal fragment having properties of a permanent magnet. The fragment has an irregular shape, with the surface and edges showing damage characteristic of an explosive effect: displacement deformation, plastic deformation, cracking, fissure, thinning along the edges and roughness (typical of viscous rupture). The surface of the investigated object retains sections of industrial origin, with a smooth surface showing traces of industrial treatment and visible black soot-like deposits.

– **investigated group of objects No. 16.6** amounts to fragments of torn black fabric showing damage in the form of tearing, fraying, charring and melting, which is typical of the brisant and thermal explosive effects. Group of investigated objects No. 16.6 has a mass of 4 grams.

Group of investigated objects No. 24 amounts to a pair of blue jeans, a white short sleeve T-shirt and a grey jumper. The jeans show damage in the form of torn trouser leg fabric and a ragged edge with fraying and poorly visible charring, which may be typical of the brisant and thermal effects of a detonated explosive, as well as deposits of a brownish-red substance in the form of spots and stains.

On the surface of this group of investigated objects there are poorly visible deposits of finely dispersed dark grey and white substances.

Group of investigated objects 25 amounts to two white gauze pads with a grey and brown substance residue.

A chemical investigation of explosive substances and products of explosion and gunfire was carried out in order to identify possible traces of explosive substances and blast products on the surfaces and in the composition of investigated objects.

Chemical investigation [3 -7, 10 – 12]

Morphological investigation (microscopy)

A microscopic investigation was conducted with the naked eye in natural daylight, as well as using a 4X magnifying glass and an MSP-1 stereomicroscope (reflected light, 80X magnification).

A morphological investigation was conducted on deposits on the surface of investigated objects in an unaltered condition (as submitted for investigation): objects of chemical investigation No. 1 – 25c.

The morphological investigation established the following:

- 1) investigated objects No. 1c, 4c – 7c, 17c, 18c, 20c and 23c are particles, fragments and fibers with varying degrees of dispersion, color and structure and having morphological properties that do not resemble the equivalent properties of explosive substances and products of explosive transformation, also no traces were found of a thermal effect or metallization characteristic of the destructive action of detonated explosive devices;
- 2) investigated objects No. 2c, 3c, 11c, 19c, 21c, 22c and 24c are particles, fragments and fibers with varying degrees of dispersion, color and structure and having morphological properties that do not resemble the equivalent properties of explosive substances. The composition of these investigated objects includes black particles of an amorphous structure (some with an oily luster) which resemble soot – products of the explosive transformation of detonated substances with a large negative oxygen balance. Traces have been found of melting and charring along the edges and in sections of the underlay, which may be characteristic of a thermal effect. No traces were found of finely dispersed metal particles (metallization);
- 3) investigated objects No. 8c, No. 13.1c – 13.3 c, No. 13.5c, No. 15c, No. 16.1c – 16.3c 16.5c and 16.6c: the bulk of deposits represent a dark grey and black amorphous substance, and the majority of investigated objects show partially transparent amorphous particles and brown-reddish fragments of an irregular and quasi- ellipsoid shape. The composition of investigated objects No. 8c, 16.1c, 16.2c and 16.6c includes separate grey and silver particles of an irregular and quasi-spherical shape and with a shiny surface, resembling metal particles;

- 4) investigated object No. 9c: the bulk of deposits represent a grey and black amorphous substance, most contain brownish-red fragments of a biological origin;
- 5) investigated objects No. 10c and No. 25c: the bulk of deposits represent white and grey particles of a crystal and amorphous structure and varying degrees of transparency; gauze fibers contain poorly visible deposits of a grey amorphously structured substance and occasional grey-silver spherical particles resembling metal particles.
- 6) investigated objects No. 12c, 13.4c and 16.4c: the bulk of deposits represent a grey amorphous substance, and the bulk of investigated objects contain reddish-brown and brownish (rust) particles and fragments, separate grey metal particles, amorphous light-grey to brown particles of an irregular and quasi-ellipsoid shape and occasional grey-silver spherical particles resembling particles of metal.

A comparison between the investigated objects and explosive substance samples from the explosive substance collection held by FEAD FRC at the Main Directorate of the Ministry of Internal Affairs of Ukraine in Kharkiv Region, as well as with the appearance of their explosive transformation products according to data in reference publications, established that their morphological characteristics (state of dispersion, structure, color, shape and particle size) are not identical to the equivalent characteristics of explosive substances.

The characteristics of the dark-grey and black amorphous substance do resemble the characteristics of explosive transformation products of brisant explosive substances with a negative oxygen balance – soot. The separate particles with characteristics of metal particles may be either components of an explosive substance or fragments of metal products affected by the explosion.

Similarities and differences were established in appearance, structural features and color.

Sample preparation

I. Preparing acetone extracts of investigated objects.

- metal fragments (debris) and dry powder were transferred into separate flasks, adding 1 - 10 ml of acetone to each (depending on the volume of investigated objects) and held for 6 hours with periodic shaking.

- the plastic and fabric fragments were sprinkled and scraped, as well as thoroughly wiped with a gauze pad dabbed in acetone; these components were combined and put in separate flasks, adding 5 ml of acetone and held for six hours with periodic shaking.

The solutions obtained were filtered through separate paper filters to obtain respective acetone extracts No. 1.1a – No. 25a, as well as insoluble residue.

II. Preparing water extracts of investigated objects.

The insoluble residues obtained at the previous stage along with respective gauze pads were transferred into separate flasks, adding 15 ml of distilled water to each and held for 6 hours with periodic shaking. After steeping, the substances obtained were filtered through separate paper filters to obtain respective water extracts No. 1.1w – No. 25w, as well as respective residues, insoluble either in acetone or water.

III. Retrieving metal particles

The irregularly shaped grey particles with a shiny surface found in the composition of investigated objects No. 8c, No. 10c, No. 12c, No. 13.4c, 16.1c, 16.2c, 16.4c and 25c, which resemble metal particles were retrieved from the composition of respective residues using a preparation needle and transferred onto separate glass plates.

All the investigated objects and their respective acetone extracts were inspected under ultraviolet light using an OLD-41 emitter, in order to determine the possible presence of fuel and lubricant substances and objects of biological origin. During the inspection, the acetone extracts of investigated objects were monitored for the presence or absence of luminescence.

Capillary chemical reactions

Qualitative chemical reactions were conducted in order to determine the characteristic components of gunfire products in the composition of investigated objects. Investigation followed the same algorithm separately for each acetone and water extract.

I. Qualitative reactions with acetone extracts.

Each acetone extract was divided into five equal aliquots, three of which were subjected to qualitative reactions, and the other two aliquots were used for thin-layer vertical chromatography investigations.

1. Determining organic oxidizer compounds (soluble in acetone)

An aliquot of the acetone extract was steamed in a jet of cool air until a dry residue, to which 1 drop was added of a 1 % solution of diphenylamine in concentrated sulphuric acid. The appearance of spots and dark-blue jets points to the presence of oxidizers.

2. Determining nitroaromatic compounds

An aliquot of the acetone extract was steamed in a jet of cool air until a dry residue, to which 1 drop of acetone was added along with 1 drop of a 1 per cent solution of sodium hydroxide in ethanol. The appearance of red and brown or blue coloring points to the presence of trinitro- or dinitroaromatic compounds, respectively.

3. Determining peroxide compounds

3.1. An aliquot of the acetone extract was transferred into a tube and steamed until the volume of 0.5 ml, to which 0.5 ml was added of a 10% sulphuric acid solution. Then 0.5 [ml] of diethyl ether was added to the resulting mixture along with several drops of a 5% potassium dichromate solution in water, after which the contents of the tube were gently shaken. After the mixture separated into the water and ether phases, it was monitored for changes in color. The appearance of blue coloring in the ether layer points to the presence of peroxide compounds.

3.2. An aliquot of the acetone extract and steamed until the volume of 0.1 ml, to which 1 ml was added of a 10% potassium iodine solution in water, oxidized by vinegar acid, carefully shaken. The appearance of yellow coloring points to the presence of peroxide compounds.

The results of investigation using the qualitative reactions method are presented in Table 1.

Table 1

Results of investigating acetone extracts of investigated objects using the qualitative reactions method

Extract No	Reaction to			
	Oxidizers	Nitroderivatives of aromatic compounds	Peroxide compounds	Presence of luminescence
1a, 4a, 5a, 6a, 7a, 11a, 17a, 18a, 20a, 23a, 25a	-	-	-/-	-
8a, 9a, 10a, 12a, 13.1a, 14a, 16.1a, 16.2a, 16.3a, 16.4a, 16.5a, 16.6a, 19a, 22a, 24a	+	+	-/-	-
3a, 13.3a, 13.4a	-	+	-/-	-
13.2a	+	-	-/-	-
13.5a, 15a	+	-	-/-	-
21a	+	+	-/-	+

II. Qualitative reactions with water extracts

One drop of investigated water extracts was entered on strips of the universal indicator paper LACHEMA (PND 50-975-84 pH 0-12), comparing the resulting changes in color to the standard scale.

Each of the investigated water extracts was divided into eight aliquots which were subjected to the following reactions:

1. Determining non-organic oxidizer compounds (soluble in water)

An aliquot of the water extract was steamed in a jet of cool air until a dry residue, to which 2 drops were added of a 1% solution of diphenylamine in concentrated sulphuric acid. The appearance of spots and dark-blue jets points to the presence of oxidizers.

2. Determining nitrite ions and nitrate ions

An aliquot of the water extract was transferred onto a glass plate, steamed in a jet of warm air until the volume of several drops, to which several granules were added of a solid Griess reagent. The appearance of a pink color points to the presence of nitrite ions.

Zinc dust was added to the obtained reaction medium. The development and appearance of a dark red color points to the presence of nitrate ions.

3. Determining ammonium cations

An aliquot of the water extract was transferred to a tube, to which 3 drops of the Nessler reagent were added. The appearance of a red and brown residue or a dark yellow color points to the presence of ammonium cations.

4. Determining potassium cations

An aliquot of the water extract was transferred into a porcelain cup and steamed until a dry residue. The residue was fried for five minutes to release possible ammonia salts which produce a similar reaction with potassium. After cooling, the residue was dissolved in a drop of distilled water, to which 1 drop was added of a saturated sodium hexanitrocobaltate solution oxidized by vinegar acid. The obtained substance was investigated under the microscope: the appearance of a residue in the form of yellow cubes and "friends" points to the presence of potassium cations.

5. Determining chlorate anions

An aliquot of the water extract was transferred onto a glass plate, steamed in a jet of warm air until dry, to which 3 drops were added of a 0.1% aniline sulphate solution in sulphuric acid. The appearance of a dark blue color points to the presence of chlorate anions.

6. Determining carbonate anions and sulphate anions

An aliquot of the water extract was transferred into a tube, adding 3 drops of a 5% barium chloride solution in water. The appearance of a white residue points to the presence of carbonate anions and sulphate anions.

Five drops of a 1 per cent hydrochloric acid solution was added to the obtained residue. Subsequent complete dissolution of the residue points to the presence of carbonate anions, gradual partial dissolution of the residue points to the joint presence of carbonate anions and sulphate anions.

7. Determining chloride anions

An aliquot of the water extract was transferred into a tube, adding 3 drops of a 5% silver nitrate solution in water. The appearance of a white residue points to the presence of chloride anions.

8. Determining metallic aluminum

A drop of a 10% potassium hydroxide solution in water was added to the metal particles extracted during sample preparation (see stage III). Gas bubbles were observed under the microscope forming around each of the investigated particles, which allows for the confirmation that these particles are those of an aluminum-based metal alloy.

The results of investigation using the qualitative reactions method are presented in Table 2

Results of investigating water extracts of investigated objects using the qualitative reactions method

Extract No	Reaction to										
	pH	Oxidizers	Nitrite anion	Nitrate anion	Ammonium cation	Potassium cation	Chlorate anion	Carbonate anion	Sulphate anion	Chloride anion	Aluminum (residue)
1a-12a, 17a, 20a, 23a	<7	+	-	+	-	+	-	+	+	+	-
13.1a-13.5a, 14a, 15a, 16.1a-16.6a	<7	+	+	+	+	+	-	+	+	+	+
24a	≈ 7	+	-	+	+	+	-	+	-	-	+
5a, 18a, 25a	≈ 7	-	-	-	-	-	-	+	-	-	-

III. Investigation of residues insoluble in acetone and water

The respective residue was transferred onto a glass plate and investigated using an MSP-1 stereomicroscope.

Shapeless black and grey-brown particles of an amorphous and polymeric nature were observed under the microscope. For all the investigated objects, the particles partially disintegrated under the action of weak and concentrated hydrochloric and sulphuric acid solutions, which does not allow their unqualified identification as fragments of soot.

Investigation using the thin-layer chromatography method

The method of vertical single-dimension straight-phase thin-layer chromatography (TLC) was used to determine traces of explosive substances, stabilizers and components of smokeless powder and gunpowder in the content of investigated objects.

For this, aliquots of the acetone extracts obtained in the process of sample preparation were steamed in a jet of cool air until the volume of several microdrops and using a capillary dropper were entered onto the starting line of chromatographic plates at the distance of 15 mm from the bottom edge of the plate.

I. Determining explosive substances, diphenylamine, and nitroglycerine

Chromatography was conducted under these conditions:

Stationary phase - Sorbfil chromatographic plates PTSX-P-A-UF (TU 26-11-17-89) measuring 10 x 10 cm with the working absorbent layer: silicagel STX-1A (layer thickness: 90...120 nm, grain fraction: 5.....17 nm) with ciliciumdioxide-based binder with the addition of luminophore at 254 nm.

Mobile phase (eluent) - acetone-toluene-hexane (1:1:2)

Preparatory Stages - cleansing with acetone-toluene-hexane (1:1:2) eluent, drying for 30 minutes at 100 C, removing the top and bottom edges of the plate each 5 mm thick and bottom corners 1 mm wide.

[seal:] Forensic Research Center No. 12 Kharkiv Region
Main Directorate Ministry of Internal Affairs of Ukraine

Forensic expert [signature]

D.A. Karakurkchi

Eluent front elevation	-	70 mm
Spot detection	-	UV light from an OLD-14 emitter, Muiroir reagent
	-	UV light from an OLD-14 emitter, 5% diphenylamine solution in ethanol, 10% potassium hydroxide solution in ethanol
Reference samples		Acetone extracts of diphenylamine and nitroglycerine

The results of the chromatography investigation are presented in Tables 3 - 5.

Table 3

TLC results in the acetone-toluene-hexane (1:1:2) solvent system, UV light from the OLD-41 emitter, 5% diphenylamine solution in ethanol, 10% potassium hydroxide solution in ethanol

Acetone extract investigated object	Stages of detection					
	Treatment in 5% diphenylamine solution in ethanol		UV treatment		Treatment in 10% potassium hydroxide solution in ethanol	
	Zone coloring	R _f	Zone coloring	R _f	Zone coloring	R _f
TEN	Colorless	0.68	Green	0.68	Green	0.68
Tetryl	Dark yellow	0.47	Yellow-orange	0.47	Red	0.47
Hexogen (RDX)	Light-grey	0.29	Green-grey	0.29	Blue-grey	0.29
Trotyl (TNT)	Yellow-orange	0.78	Orange-brown	0.78	Red-brown	0.78
Octagen	Light grey	0.14	Green-grey	0.14	Blue-grey	0.14
2a, 8a, 9a, 10a, 12a, 13.1a, 13.2a, 14a, 16.1a, 16.2a, 16.3a, 16.4a, 16.5a, 16.6a, 19a, 22a	Light-grey	0.29	Green-grey	0.29	Blue-grey	0.29
	Yellow-orange	0.78	Orange-brown	0.78	Red-brown	0.78
1a, 4a, 5a, 6a, 11a, 17a, 18a, 20a, 23a, 25a	-	-	-	-	-	-
3a, 7a, 24a	Yellow-orange	0.78	Orange-brown	0.78	Red-brown	0.78

TLC results in the acetone-toluene-hexane (1:1:2) solvent system, UV light from the OLD-41 emitter, Muiroir reagent

Investigated object (acetone extract No)	Stages of detection			
	UV light		Treatment with Muiroir reagent	
	Zone coloring	R _f	Zone coloring	R _f
Reference sample: diphenylamine	Grey	0.78	Blue	0.78
1a - 25a	-	-	-	-

The investigation established that the chromatograms of acetone extracts shows zones with the coloring and chromatographic mobility value R_f characteristic of :

- extracts 2a, 8a, 9a, 10a, 12a, 13.1a, 13.2a, 14a, 16.1a, 16.2a, 16.3a, 16.4a, 16.5a, 19a, 22a and 25a - trotyl/TNT and hexogen/RDX;
- extracts 3a, 7a, 24a - trotyl/TNT.

II. Determining sulphur

Chromatography was conducted under the following conditions:

Stationary phase - Sorbfil chromatographic plate PTSX-P-A-UF (TU 26-11-17- 89) measuring 10 x 10 cm with the working absorbent layer: silicagel STX-1A (layer thickness: 90...120 nm, grain fraction: 5.....17 nm) with a ciliciumdioxide-based binder and the addition of luminophore at 254 nm.

Mobile phase - heptane

Preparatory - cleansing with heptanes eluent, drying for 30 minutes at 100 C, removing the top and bottom edges of the plate 5 mm thick each and bottom corners 1 mm wide.

Stages

Eluent front elevation - 70 mm

Spot detection pulverization by 5% water solution of silver nitrate, activation by UV light from an OLD-41 emitter

Reference samples Acetone extract of Sulphur

Table 5

TLC results in the heptane solvent system

Investigated object (acetone extract No)	Stages of detection			
	Treatment in 5% water solution of silver nitrate		UV light	
	Zone coloring	R _f	Zone coloring	R _f
Reference sample: acetone extract of sulphur	Yellow-brown	0.95	Brown	0.95
1a - 25a	-	-	-	-

The investigation has established that there is no Sulphur present in the composition investigated objects.

Therefore, after summarizing separate investigations conducted, the following has been established:

- according to the results of morphological investigation: the appearance and morphological characteristics of the amorphous dark grey and black substance found in the composition of investigated objects No. 2c, 3c, 8c – 16c, 19c, 21c, 22c, and 24c are not identical to the equivalent characteristics of explosive Substances, but do resemble products of the blast transformation of brisant explosives with a negative oxygen balance;
- the results of the qualitative capillary analysis show that the composition of investigated objects includes trinitro-derivatives of aromatic compounds: oxidizers, nitrite, nitrate and carbonate anions, ammonium and potassium cations, metallic aluminum, trace amounts of petroleum products (within the margin of error), soot (probably) and other characteristic ions, according to Tables 1 and 2.
- investigation using the thin-layer chromatography method established that
 - the composition of investigated objects No. 2a, 8a, 9a, 10a, 12a, 13.1a, 13.2a, 14a, 16.1a, 16.2a, 16.3a, 16.4a, 16.5a, 19a, and 22a includes traces of explosive substances trotyl (TNT) and hexogen (RDX).
 - the composition of extracts No. 3a, 7a, and 24a includes traces of explosive substance trotyl (TNT).

An evaluation of the summarized results of chemical investigation makes it possible to draw the following conclusions:

- investigated objects No. 2, 8, 9, 10, 12, 13.1, 13.2, 14, 16.1, 16.2, 16.3, 16.4, 16.5, 19, and 22 contain traces of the blast products of explosive substances based on trotyl (TNT) and hexogen (RDX);
- investigated objects No. 3, 7, and 24 contain traces of the blast products of explosive substances based on trotyl (TNT).

Despite the fact that a large number of explosive substances contain metallic aluminum (for example, finely dispersed aluminum makes up 17% to 27% of the MS explosive substance), the metal particles of an aluminum-based alloy found in the composition of investigated objects No. 8, No. 10, No. 12, No. 13.4, 16.1, 16.2, No. 16.4, and 16.6 cannot be unequivocally identified with blast products, due to extensive presence of aluminum in the environment; aluminum may also be contained in components of an explosive device (casing, detonator cup, etc) or in the interior of the blast scene (furniture, utensils, electrical parts, etc).

Comparative investigation [1 - 12]

A comparative investigation was conducted to establish whether investigated objects No. 8, No. 9, No. 12, No. 13.1 and No. 16.1 – 16.5 could be grouped, by juxtaposing the characteristics of investigated objects with those of examples of industrially made and improvised explosive devices from the FEAD FRC collection and with the characteristics and descriptions of explosive devices, their components and items of dual use available in reference sources.

A study of the documents, appearance, separate investigations and chemical investigation (of explosive substances and products of explosion and gunfire) established that these investigated objects have the following characteristics:

1. Investigated object No. 8:

- shape: cylindrical;
- material: aluminum-based metal alloy;
- characteristic constructive elements: cap, bushing, grooved bushing, remnants of a cutter and a metallic element;
- evidence of industrial make;
- damage (traces) typical of the brisant and thermal effects of detonated explosive substances;
- damage (traces) typical of mechanical effects (impact, contact);
- present traces of an explosive substance: trotyl (TNT) and hexogen (RDX).

Considering the results obtained, a comparison was made between the characteristics of investigated object No. 8 and those of a reference example from the FEAD FRC collection - a delayed-action VZD-1M fuze (diagrams 1 and 2) - and its descriptions in reference sources.

As a result of comparison, investigated object No. 8 was established to share identical characteristics with those of the top part of delayed action fuze VZD-1M (without part of the casing, the firing pin and spring), which sustained the brisant, incendiary and thermal effects of the explosion, as well as with its description in reference sources.

Similarity was established due to the appearance, material, geometric shape, structural features, size, nature of damage and present traces of an explosive substance based on trotyl (TNT) and hexogen (RDX).

Figure 79. VZD-1M fuze.
 a – appearance; b – cross-section; 1 – cap;
 2 – cutter; 3 – metal element; 4 – catch; 5 – bushing; 6 – grooved bushing; 7 – casing; 8 – firing pin; 9 – combat spring; 10 – membrane; 11 – fuse MD-5M.

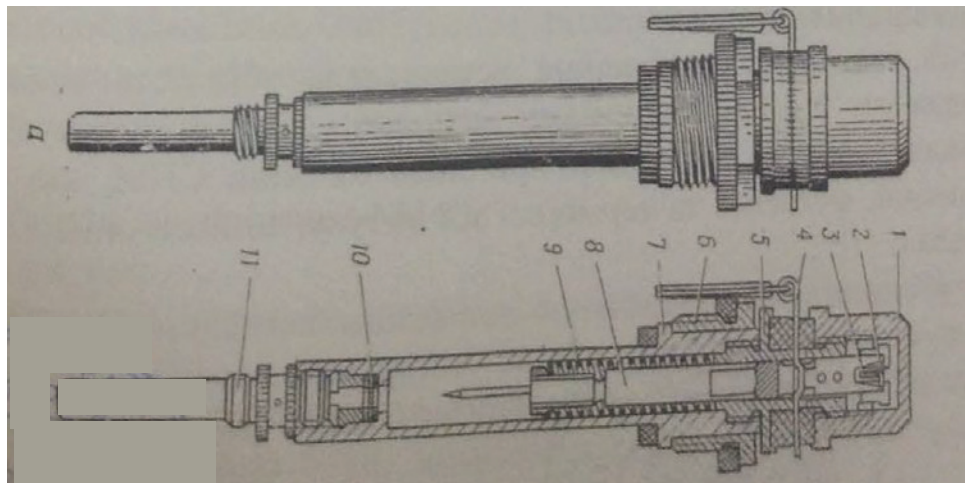

Diagram 1. VZD-1M fuze (external appearance and cross-section)

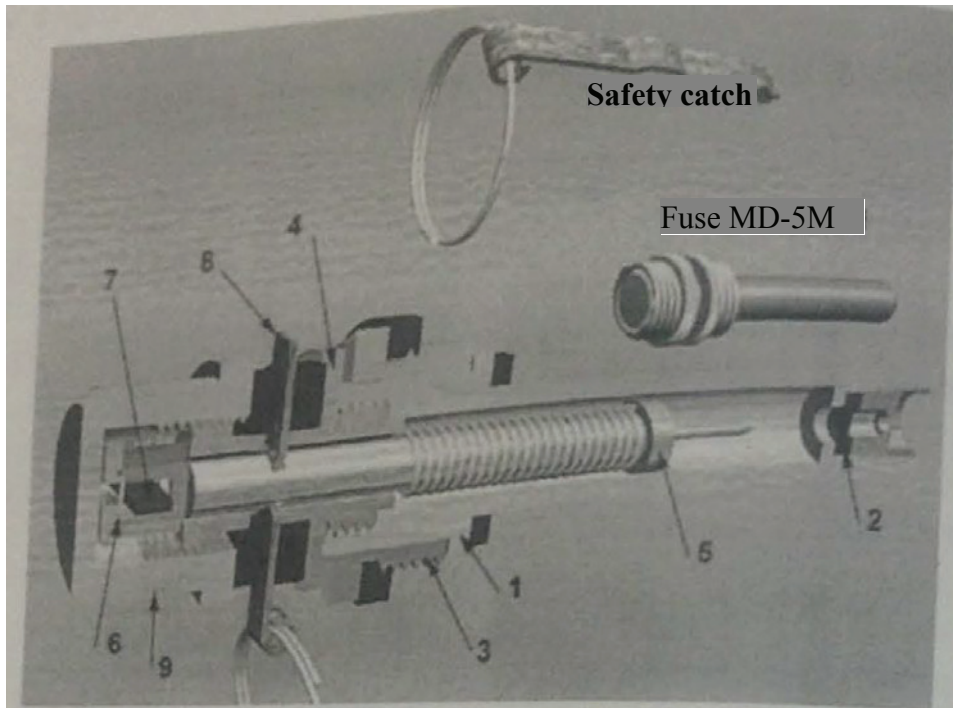

Diagram 2 – VZD – 1M fuze (cross section)

2. Group of investigated objects No. 13.1:

- shape – irregular, with external (protruding) and internal (concave) sides;
- material – aluminum-based metal alloy;
- characteristic structural elements:
 - on the outer side: parallel transverse grooves (signs of industrial treatment) about 0.1 mm wide, some fragments have 6-7 mm wide rectangular indentations with remnants of bevels;
 - on the inner side: remnants of grooving;
- signs of industrial make;
- damage (traces) typical of the brisant and thermal effects of detonated explosive substances;
- present traces of an explosive substance: trotyl (TNT) and hexogen (RDX).

Considering the results obtained, a comparison was made between the characteristics of the group of investigated objects No. 13.1 and those of a reference example from the FEAD FRC collection – the external end of the fuze attachment cup from the casing of the SPM medium limpet mine (diagram 3) and its descriptions in reference sources.

As a result of comparison, group of investigated objects No. 13.1 was established to share identical characteristics with those of the fuze attachment cup from the casing of the SPM medium limpet mine, which sustained the brisant, incendiary, and thermal effects of the explosion, as well as with its description in reference sources.

Similarity was established due to the appearance, geometric shape, structural features, material, size, nature of damage and present traces of an explosive substance based on trotyl (TNT) and hexogen (RDX).

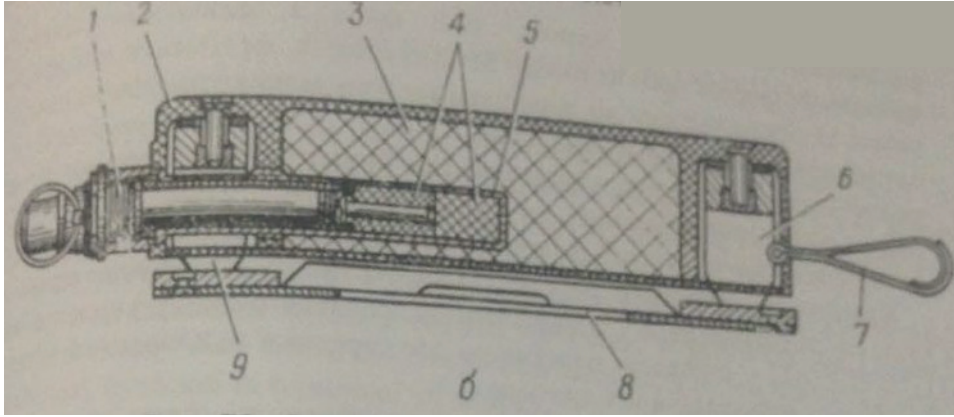

Figure 78. SPM medium limpet mine:

a) general appearance (without steel plate); b) cross-section; 1 – VZD-1M fuze; 2 – casing; 3 – VV charge; 4 – additional detonator; 5 – cup; 6 and 9 – magnets; 7 – string loop; 8 – steel plate.

Diagram 3 – Medium limpet mine (cross-section)

3. Investigated objects No. 13.2 and 16.3:

- shape: cylindrical;
- material: ferrum-based metal alloy (responsive to permanent magnetic field);
- characteristic structural elements: fragment of external grooving;
- evidence of industrial make;
- damage (traces) typical of the brisant effect of detonated explosive substances;
- present traces of an explosive substance: trotyl (TNT) and hexogen (RDX).

Considering the results obtained, a comparison was made between the characteristics of investigated objects No. 13.2 and 16.3 and those of a reference example from the FEAD FRC collection - a fixing bolt from the cap of SPM limpet mine casing - and its descriptions in reference sources.

As a result of comparison, investigated objects No. 13.2 and 16.3 are established to share identical characteristics with those of a fixing bolt from the cap of SPM limpet mine casing, which sustained the brisant, incendiary, and thermal effects of the explosion, as well as with its description in reference sources.

Similarity was established due to the appearance, geometric shape, structural features, material, size, nature of damage and present traces of an explosive substance based on trotyl (TNT) and hexogen (RDX).

4. Group of investigated objects No. 16.1:

- shape – cylindrical;
- material – ferrum-based metal alloy (responsive to permanent magnetic field);
- characteristic structural elements: external (protruding) and internal (concave) sides, remnants of rivets and corresponding holes

arranged in a certain way, edges retaining a regularly shaped configuration of industrial origin and bits of grey paintwork on the outer surface of some fragments;

- signs of industrial make;
- damage (traces) typical of the brisant and thermal effects of detonated explosive substances;
- present traces of an explosive substance: trotyl (TNT) and hexogen (RDX).

Considering the results obtained, a comparison was made between the characteristics of the group of investigated objects No. 16.1 and those of a reference example from the FEAD FRC collection – a steel plate for the SPM medium limpet mine and its descriptions in reference sources.

As a result of comparison, group of investigated objects No. 16.1 was established to share identical characteristics with those of a steel plate for the SPM medium limpet mine, which sustained the brisant, incendiary and thermal effects of the explosion.

Similarity was established due to the appearance, geometric shape, structural features, material, size, nature of damage and present traces of an explosive substance based on trotyl (TNT) and hexogen (RDX).

5. Group of investigated objects No. 13.3, investigated object No. 16.2:

- shape – irregular, with external (protruding) and internal (concave) sides;
- material – aluminum-based metal alloy;
- characteristic structural elements: parallel transverse grooves (signs of mechanical treatment) about 0.1 mm wide
- damage of thermal origin;
- present traces of an explosive substance: trotyl (TNT) and hexogen (RDX).

Considering the results obtained, a comparison was made between the characteristics of the group of investigated objects No. 13.3, investigated object No. 16.2 and those of a reference example from the FEAD FRC collection – the additional detonator cup of an SPM mine and its descriptions in reference sources.

As a result of comparison, group of investigated objects No. 13.3 and investigated object No. 16.2 are established, probably, to be fragments of an additional detonator cup from the casing of an SPM mine, which were a result of destruction under the brisant, incendiary and thermal effects of the explosion.

6. Group of investigated objects No. 12, investigated objects No. 13.4, 16.5:

- shape – irregular, with external (protruding) and internal (concave) sides;
- material –metal alloy with the properties of a permanent magnet;
- signs of industrial make;
- damage (traces) typical of the brisant and thermal effects of detonated explosive substances;
- damage (traces) typical of mechanical effects (impact, contact);

- present traces of an explosive substance: trotyl (TNT) and hexogen (RDX).

Considering the results obtained, a comparison was made between the characteristics of the group of investigated objects No. 12, investigated objects No. 13.4 and 16.5 and those of a reference example from the FEAD FRC collection – magnets from an SPM mine - and its descriptions in reference sources.

As a result of comparison, group of investigated objects No. 12 and investigated objects No. 13.4 and 16.5 are established, probably, to be magnet fragments from an SPM mine formed as a result of destruction under the brisant, incendiary and thermal effects of the explosion.

7. Group of investigated objects No. 13.5:

- shape – in the form of fragments of a cylindrically coiled spring around 0.1 mm in diameter;
- material – metal;
- signs of industrial make;
- damage (traces) typical of the brisant and thermal effects of detonated explosive substances;
- damage (traces) typical of mechanical effects (impact, contact);
- present traces of an explosive substance: trotyl (TNT) and hexogen (RDX).

Considering the results obtained, a comparison was made between the characteristics of the group of investigated objects No. 13.5 and those of a reference example from the FEAD FRC collection – the spring of a delayed action fuze VZD-1M - and its descriptions in reference sources.

As a result of comparison, group of investigated objects No. 13.5 are established, probably, to be fragments of a spring from the VZD-1M delayed action fuze formed as a result of destruction under the brisant, incendiary and thermal effects of the explosion.

According to reference sources: “an explosive device is a single-use improvised or industrially manufactured device prepared specifically for an explosion intended to injure people or destroy surrounding objects using the fast chemical transformation energy of condensed substances. Explosive devices can be industrially manufactured as well as improvised.

“Explosive devices are known to contain main and auxiliary elements. The main elements are an explosive charge and the means of initiating the explosion. The auxiliary elements are the casing, executive and safety mechanism, ready destructive elements, masking elements, camouflage and fixings.

“Explosive devices and their elements can be made industrially or they can be improvised. An industrially made explosive device is a factory-made explosive device which conforms to normative technical documentation.

An improvised explosive device is an explosive device at least one element of which has been improvised, or which has been assembled or equipped outside the industrial process or in an unregulated manner.” [4.5].

Therefore, having summarized the separate investigations conducted, the following has been established:

1. According to the results of documentary research, an explosive device was detonated on the floor next to the bar on the premises of the Stena bar. The device was equipped with an explosive charge with the power of about 1 - 1.2 kg in TNT equivalent.

2. According to the results of investigation of the explosive substances and products of explosion and gunfire:

- investigated objects No. 2, 8, 9, 10, 12, 13.1, 13.2, 14, 16.1, 16.2, 16.3, 16.4, 16.5, 19, and 22 contain traces of the blast products of explosive substances based on trotyl (TNT) and hexogen (RDX);
- investigated objects No. 3, 7 and 24 contain traces of the blast products of explosive substances based on trotyl (TNT).

The explosive substance detonated may have contained metallic aluminum.

3. The separate and comparative investigations have established that the objects found at the scene of the incident are probably parts of an explosive device, namely:

- fragments of a delayed action VZD-1M fuze;
- casing fragments from an SPM medium limpet mine and fragments of an SPM steel plate.

Having evaluated the summarized results of separate investigations, the following conclusions can be drawn:

1. Around 21:38 on 11.09.2014, an SPM medium limpet mine with a delayed action VZD-1M fuze was detonated at the Stena bar (13 vul. Rymarska, Kharkiv). An SPM mine with a VZD-1M fuze is equipped with an MS brisant explosive charge of normal strength (57% hexogen (RDX), 19% trotyl (TNT), 17% aluminum, 7% phlegmatizer (ceresin)) of 1 kg in mass, which belongs to an industrially made category of ammunition. An SPM mine is an anti-object time-fuse incendiary mine intended for destroying movable and stationary items with metal parts, and can be used on land and under water.
2. A delayed action VZD-1M fuze was used to detonate the SPM mine, which was installed the mine casing, activated with a time delay and working in a standard way.
3. No specialist professional knowledge, education or military mine, explosive or engineering training is required to use an SPM mine with a VZD-1M fuze.

The procedure and rules of operation can be obtained independently from freely available open sources. It should be noted that the period between activating a VZD-1M fuze and the moment of explosion can take from tens of minutes to several days, depending on the number of the metal element (time delay mechanism) and the ambient temperature. Therefore, in breach of the rules for preparing and using this type of mines, it is possible to activate a VZD-1M fuze before the mine is installed on site.

The following reference sources were used during this expert analysis:

1. Order No. 19/1-272n by the State Forensic Research Center of the Ministry of Internal Affairs of Ukraine dated October 31, 2013 “On approving the Instruction on the procedure and documentation of forensic analyses.”
2. Order No. 653 by the Ministry of Internal Affairs of Ukraine dated 07.09.2014 “On approving the instruction on handling explosive materials in the agencies and departments of internal affairs of Ukraine.”
3. V.N. Aginsky, V.I. Golyashin, S.V. Vladimirov. Forensic investigation of explosive substances/ Edited by N.M. Kuzmin, Moscow: All-USSR Research Institute of the Ministry of Internal Affairs of the USSR, 1985, - 72 pages.
4. V.N. Dik. Soviet-made explosive substances, powders and ammunition. In two parts. Part 1, 2. Pictures and illustrations: Reference manual/V.N. Dik – Minsk: “Okhotkontrakt,” 2009 – 240 pages.
5. Yu.M. Dildin, V.V. Martynov et al. “Industrially made explosive devices and their forensic investigation.” Moscow. Expert Forensic Center of the Ministry of Internal Affairs of the Russian Federation. 1991, 120 pages.
6. Yu.M. Dildin, V.V. Martynov et al. “Scene of explosion as an object of forensic investigation.” Moscow. Expert Forensic Center of the Ministry of Internal Affairs of the Russian Federation. 1995, 98 pages.
7. Yu.M. Dildin, V.V. Martynov, A.Yu. Semenov, A.A. Shmyrev. Fundamentals of forensic investigation of improvised explosive devices: Study guide. – M.: All-USSR Forensic Research Center of the USSR Ministry of Internal Affairs, 1991. – 94 pages.
8. “Explosive ammunition.” Book 1. Ministry of Defense of the USSR. M.: 1976, 242 pages.
9. “Explosive ammunition.” Book 2. Ministry of Defense of the USSR, M.: 1976, 184 pages.
10. G.V. Prokhorov-Lukin, V.I. Bykov, V.I. Pashchenko “Methodology for a comprehensive analysis of explosive devices, explosive substances and traces of explosion.” Kyiv, Elite Print, 2011, 216 pages.
11. S.M. Sokolov, Forensic chemical analysis of material evidence. – M.: “Medicine,” 1964. –pp.137-192.
12. V.N. Tsvetkova, L.K. Isayeva “Using thin-layer chromatography and infra-red spectroscopy in investigating certain industrial explosives.” “Expert practice and new investigation methods” journal, issue 9. M.: All-USSR Forensic Research Institute -1975, pp 7 – 16.

The following was used during inspection and investigation: MSP-1 stereomicroscope No. XS 3740, certificate of conformity No. 03/8773; metal gauge GOST 427-75, Vernier caliper ShTs-1 (No. 393935), certificate of conformity No. 03/8745; expert magnifying glass; CAS electronic scales of $\pm 1.0g$ precision (No. 98050605), OLD 41 emitter, samples No. 1-50 of explosive substances from the FEAD FRC collection, a set of chemical reagents, Sorbfil plates for thin-layer chromatography (TU 26-11-17-89). The capture and printing of images was done using digital camera Canon PowerShot A 630, the Intel (R) Celeron (R) PC, CPU 2.8 GHz, 960 GB RPM and laser printer CANON LBP-2900.

The investigated objects have been returned to their original packaging. The necks of packages No. 1 – No. 3, No. 5 – No. 7, No. 10 – No. 25 are tied with white string. The loose ends of the string are attached to a quadrangular piece of white paper folded in half, the label. The openings of packages No. 4, No. 8, and No. 9 are sealed with labels covered with fragments of a clear plastic adhesive tape (scotch tape).

The labels are made in the manner of a form with black print and contain expert signatures in longhand using blue ink as well as a blue round seal of the Forensic Research Center No. 12, Kharkiv Region Main Directorate, Ministry of Internal Affairs of Ukraine:

The content of the labels is as follows:

1) package No. 1

Forensic Research Center, Main Directorate of the Ministry of Internal Affairs of Ukraine in Kharkiv Region			
QF.57-5.8-01.00. 1	Label for object	Version	1
		Page	36 of 1
Object No. 1 Conclusion No. 532/2014 of 04.03.215 Package No. 1 Object description: fragment of fabric (provided by Senior Forensic Investigator, investigations department of the Security Service of Ukraine Kharkiv Regional directorate, Senior Lieutenant of Justice I.M. Babak as part of criminal proceedings No. 22014220000000305) Name of expert: D.A. Karakurkchi Signature (signature) Date: 04.03.2015 (imprint of FEAD FRC seal)			
Danger category: extremely dangerous –dangerous –somewhat dangerous - <u>safe</u> DANGER: EXPLOSIVE			

2) package No. 2

Forensic Research Center, Main Directorate of the Ministry of Internal Affairs of Ukraine in Kharkiv Region			
QF.57-5.8-01.00. 1	Label for object	Version	1
		Page	36 of 1
Object No. 2 Conclusion No. 532/2014 of 04.03.215 Package No. 2 Object description: damaged wallet (provided by Senior Forensic Investigator, investigations department of the Security Service of Ukraine Kharkiv Regional directorate, Senior Lieutenant of Justice I.M. Babak as part of criminal proceedings No. 22014220000000305) Name of expert: D.A. Karakurkchi Signature (signature) Date: 04.03.2015 (imprint of FEAD FRC seal)			
Danger category: extremely dangerous –dangerous –somewhat dangerous - <u>safe</u> DANGER: EXPLOSIVE			

[seal:] Forensic Research Center No. 12 Kharkiv Region
 Main Directorate Ministry of Internal Affairs of Ukraine
 Forensic expert [signature]

D.A. Karakurkchi

3) package No. 3

Forensic Research Center, Main Directorate of the Ministry of Internal Affairs of Ukraine in Kharkiv Region			
QF.57-5.8-01.00. 1	Label for object	Version	1
		Page	37 of 1

Object No. 3
Conclusion No. 532/2014 of 04.03.215
 Package No. 3
 Object description: bank notes (hryvnias) (provided by Senior Forensic Investigator, investigations department of the Security Service of Ukraine Kharkiv Regional directorate, Senior Lieutenant of Justice I.M. Babak as part of criminal proceedings No. 22014220000000305)

Name of expert: D.A. Karakurkchi
 Signature (signature) Date: 04.03.2015
 (imprint of FEAD FRC seal)

Danger category:
~~extremely dangerous~~
~~–dangerous~~
~~–somewhat dangerous~~
- safe
~~DANGER: EXPLOSIVE~~

4) package No. 4

Forensic Research Center, Main Directorate of the Ministry of Internal Affairs of Ukraine in Kharkiv Region			
QF.57-5.8-01.00. 1	Label for object	Version	1
		Page	37 of 1

Object No. 4
Conclusion No. 532/2014 of 04.03.215
 Package No. 4
 Object description: Lenovo laptop (provided by Senior Forensic Investigator, investigations department of the Security Service of Ukraine Kharkiv Regional directorate, Senior Lieutenant of Justice I.M. Babak as part of criminal proceedings No. 22014220000000305)

Name of expert: D.A. Karakurkchi
 Signature (signature) Date: 04.03.2015
 (imprint of FEAD FRC seal)

Danger category:
~~extremely dangerous~~
~~–dangerous~~
~~–somewhat dangerous~~
- safe
~~DANGER: EXPLOSIVE~~

5) package No. 5

Forensic Research Center, Main Directorate of the Ministry of Internal Affairs of Ukraine in Kharkiv Region			
QF.57-5.8-01.00. 1	Label for object	Version	1
		Page	37 of 1

Object No. 5
Conclusion No. 532/2014 of 04.03.215
 Package No. 5
 Object description: four quadrangular emblems and four shield-shaped emblems (provided by Senior Forensic Investigator, investigations department of the Security Service of Ukraine Kharkiv Regional directorate, Senior Lieutenant of Justice I.M. Babak as part of criminal proceedings No. 22014220000000305)

Name of expert: D.A. Karakurkchi
 Signature (signature) Date: 04.03.2015
 (imprint of FEAD FRC seal)

Danger category:
~~extremely dangerous~~
~~–dangerous~~
~~–somewhat dangerous~~
- safe
~~DANGER: EXPLOSIVE~~

6) package No. 6

Forensic Research Center, Main Directorate of the Ministry of Internal Affairs of Ukraine in Kharkiv Region			
QF.57-5.8-01.00. 1	Label for object	Version	1
		Page	37 of 1

Object No. 6
Conclusion No. 532/2014 of 04.03.215
 Package No. 6
 Object description: three laptops and two chargers (provided by Senior Forensic Investigator, investigations department of the Security Service of Ukraine Kharkiv Regional directorate, Senior Lieutenant of Justice I.M. Babak as part of criminal proceedings No. 22014220000000305)

Name of expert: D.A. Karakurkchi
 Signature (signature) Date: 04.03.2015
 (imprint of FEAD FRC seal)

Danger category:
~~extremely dangerous~~
~~–dangerous~~
~~–somewhat dangerous~~
- safe
~~DANGER: EXPLOSIVE~~

[seal:] Forensic Research Center No. 12 Kharkiv Region
 Main Directorate Ministry of Internal Affairs of Ukraine
 Forensic expert [signature]

D.A. Karakurkchi

7) package No. 7

Forensic Research Center, Main Directorate of the Ministry of Internal Affairs of Ukraine in Kharkiv Region			
QF.57-5.8-01.00. 1	Label for object	Version	1
		Page	38 of 1
Object No. 7 Conclusion No. 532/2014 of 04.03.215 Package No. 7 Object description: short blue jacket of manmade material with zip fastening (provided by Senior Forensic Investigator, investigations department of the Security Service of Ukraine Kharkiv Regional directorate, Senior Lieutenant of Justice I.M. Babak as part of criminal proceedings No. 2201422000000305) Name of expert: D.A. Karakurkchi Signature (signature) Date: 04.03.2015 (imprint of FEAD FRC seal)			
Danger category: extremely dangerous –dangerous –somewhat dangerous - <u>safe</u> DANGER: EXPLOSIVE			

8) package No. 8

Forensic Research Center, Main Directorate of the Ministry of Internal Affairs of Ukraine in Kharkiv Region			
QF.57-5.8-01.00. 1	Label for object	Version	1
		Page	38 of 1
Object No. 8 Conclusion No. 532/2014 of 04.03.215 Package No. 8 Object description: fragment of VZD-1M fuze (provided by Senior Forensic Investigator, investigations department of the Security Service of Ukraine Kharkiv Regional directorate, Senior Lieutenant of Justice I.M. Babak as part of criminal proceedings No. 2201422000000305) Name of expert: D.A. Karakurkchi Signature (signature) Date: 04.03.2015 (imprint of FEAD FRC seal)			
Danger category: extremely dangerous –dangerous –somewhat dangerous - <u>safe</u> DANGER: EXPLOSIVE			

9) package No. 9

Forensic Research Center, Main Directorate of the Ministry of Internal Affairs of Ukraine in Kharkiv Region			
QF.57-5.8-01.00. 1	Label for object	Version	1
		Page	38 of 1
Object No. 9 Conclusion No. 532/2014 of 04.03.215 Package No. 9 Object description: metal fragment (provided by Senior Forensic Investigator, investigations department of the Security Service of Ukraine Kharkiv Regional directorate, Senior Lieutenant of Justice I.M. Babak as part of criminal proceedings No. 2201422000000305) Name of expert: D.A. Karakurkchi Signature (signature) Date: 04.03.2015 (imprint of FEAD FRC seal)			
Danger category: extremely dangerous –dangerous –somewhat dangerous - <u>safe</u> DANGER: EXPLOSIVE			

10) package No. 10

Forensic Research Center, Main Directorate of the Ministry of Internal Affairs of Ukraine in Kharkiv Region			
QF.57-5.8-01.00. 1	Label for object	Version	1
		Page	38 of 1
Object No. 10 Conclusion No. 532/2014 of 04.03.215 Package No. 10 Object description: gauze pad (provided by Senior Forensic Investigator, investigations department of the Security Service of Ukraine Kharkiv Regional directorate, Senior Lieutenant of Justice I.M. Babak as part of criminal proceedings No. 2201422000000305) Name of expert: D.A. Karakurkchi Signature (signature) Date: 04.03.2015 (imprint of FEAD FRC seal)			
Danger category: extremely dangerous –dangerous –somewhat dangerous - <u>safe</u> DANGER: EXPLOSIVE			

[seal:] Forensic Research Center No. 12 Kharkiv Region
 Main Directorate Ministry of Internal Affairs of Ukraine
 Forensic expert [signature]

D.A. Karakurkchi

11) package No. 11

Forensic Research Center, Main Directorate of the Ministry of Internal Affairs of Ukraine in Kharkiv Region			
QF.57-5.8-01.00. 1	Label for object	Version	1
		Page	39 of 1
Object No. 11 Conclusion No. 532/2014 of 04.03.215 Package No. 11 Object description: fragment of white-and-green fabric with pocket (provided by Senior Forensic Investigator, investigations department of the Security Service of Ukraine Kharkiv Regional directorate, Senior Lieutenant of Justice I.M. Babak as part of criminal proceedings No. 2201422000000305) Name of expert: D.A. Karakurkchi Signature (signature) Date: 04.03.2015 (imprint of FEAD FRC seal)			
Danger category: extremely dangerous -dangerous -somewhat dangerous - safe DANGER: EXPLOSIVE			

12) package No. 12

Forensic Research Center, Main Directorate of the Ministry of Internal Affairs of Ukraine in Kharkiv Region			
QF.57-5.8-01.00. 1	Label for object	Version	1
		Page	39 of 1
Object No. 12 Conclusion No. 532/2014 of 04.03.215 Package No. 12 Object description: magnet fragments(provided by Senior Forensic Investigator, investigations department of the Security Service of Ukraine Kharkiv Regional directorate, Senior Lieutenant of Justice I.M. Babak as part of criminal proceedings No. 2201422000000305) Name of expert: D.A. Karakurkchi Signature (signature) Date: 04.03.2015 (imprint of FEAD FRC seal)			
Danger category: extremely dangerous -dangerous -somewhat dangerous - safe DANGER: EXPLOSIVE			

13) package No. 13

Forensic Research Center, Main Directorate of the Ministry of Internal Affairs of Ukraine in Kharkiv Region			
QF.57-5.8-01.00. 1	Label for object	Version	1
		Page	39 of 1
Object No. 13 Conclusion No. 532/2014 of 04.03.215 Package No. 13 Object description: fragments of a fuze spring, fuze attachment cup, additional detonator cup, bolt and magnet (from SPM mine casing) (provided by Senior Forensic Investigator, investigations department of the Security Service of Ukraine Kharkiv Regional directorate, Senior Lieutenant of Justice I.M. Babak as part of criminal proceedings No. 2201422000000305) Name of expert: D.A. Karakurkchi Signature (signature) Date: 04.03.2015 (imprint of FEAD FRC seal)			
Danger category: extremely dangerous -dangerous -somewhat dangerous - safe DANGER: EXPLOSIVE			

14) package 14

Forensic Research Center, Main Directorate of the Ministry of Internal Affairs of Ukraine in Kharkiv Region			
QF.57-5.8-01.00. 1	Label for object	Version	1
		Page	39 of 1
Object No. 14 Conclusion No. 532/2014 of 04.03.215 Package No. 14 Object description: bits of torn fabric (provided by Senior Forensic Investigator, investigations department of the Security Service of Ukraine Kharkiv Regional directorate, Senior Lieutenant of Justice I.M. Babak as part of criminal proceedings No. 2201422000000305) Name of expert: D.A. Karakurkchi Signature (signature) Date: 04.03.2015 (imprint of FEAD FRC seal)			
Danger category: extremely dangerous -dangerous -somewhat dangerous - safe DANGER: EXPLOSIVE			

[seal:] Forensic Research Center No. 12 Kharkiv Region
 Main Directorate Ministry of Internal Affairs of Ukraine
 Forensic expert [signature]

D.A. Karakurkchi

15) package No. 15

Forensic Research Center, Main Directorate of the Ministry of Internal Affairs of Ukraine in Kharkiv Region			
QF.57-5.8-01.00. 1	Label for object	Version	1
		Page	40 of 1

Object No. 15
Conclusion No. 532/2014 of 04.03.215
 Package No. 15
 Object description: metal plate (provided by Senior Forensic Investigator, investigations department of the Security Service of Ukraine Kharkiv Regional directorate, Senior Lieutenant of Justice I.M. Babak as part of criminal proceedings No. 2201422000000305)

Name of expert: D.A. Karakurkchi
 Signature (signature) Date: 04.03.2015
 (imprint of FEAD FRC seal)

Danger category:
~~extremely dangerous~~
~~–dangerous~~
~~–somewhat dangerous~~
 - safe
DANGER: EXPLOSIVE

16) package 16

Forensic Research Center, Main Directorate of the Ministry of Internal Affairs of Ukraine in Kharkiv Region			
QF.57-5.8-01.00. 1	Label for object	Version	1
		Page	40 of 1

Object No. 16
Conclusion No. 532/2014 of 04.03.215
 Package No. 16
 Object description: fragments of an SPM steel plate, bolt, additional detonator cup and magnet, bits of torn fabric (provided by Senior Forensic Investigator, investigations department of the Security Service of Ukraine Kharkiv Regional directorate, Senior Lieutenant of Justice I.M. Babak as part of criminal proceedings No. 2201422000000305)

Name of expert: D.A. Karakurkchi
 Signature (signature) Date: 04.03.2015
 (imprint of FEAD FRC seal)

Danger category:
~~extremely dangerous~~
~~–dangerous~~
~~–somewhat dangerous~~
 - safe
DANGER: EXPLOSIVE

17) package No. 17

Forensic Research Center, Main Directorate of the Ministry of Internal Affairs of Ukraine in Kharkiv Region			
QF.57-5.8-01.00. 1	Label for object	Version	1
		Page	40 of 1

Object No. 17
Conclusion No. 532/2014 of 04.03.215
 Package No. 17
 Object description: red-and-black flag (provided by Senior Forensic Investigator, investigations department of the Security Service of Ukraine Kharkiv Regional directorate, Senior Lieutenant of Justice I.M. Babak as part of criminal proceedings No. 2201422000000305)

Name of expert: D.A. Karakurkchi
 Signature (signature) Date: 04.03.2015
 (imprint of FEAD FRC seal)

Danger category:
~~extremely dangerous~~
~~–dangerous~~
~~–somewhat dangerous~~
 - safe
DANGER: EXPLOSIVE

18) package No. 18

Forensic Research Center, Main Directorate of the Ministry of Internal Affairs of Ukraine in Kharkiv Region			
QF.57-5.8-01.00. 1	Label for object	Version	1
		Page	40 of 1

Object No. 18
Conclusion No. 532/2014 of 04.03.215
 Package No. 18
 Object description: scarf and man's tracksuit top (provided by Senior Forensic Investigator, investigations department of the Security Service of Ukraine Kharkiv Regional directorate, Senior Lieutenant of Justice I.M. Babak as part of criminal proceedings No. 2201422000000305)

Name of expert: D.A. Karakurkchi
 Signature (signature) Date: 04.03.2015
 (imprint of FEAD FRC seal)

Danger category:
~~extremely dangerous~~
~~–dangerous~~
~~–somewhat dangerous~~
 - safe
DANGER: EXPLOSIVE

[seal:] Forensic Research Center No. 12 Kharkiv Region
 Main Directorate Ministry of Internal Affairs of Ukraine
 Forensic expert [signature]

D.A. Karakurkchi

19) package No. 19

Forensic Research Center, Main Directorate of the Ministry of Internal Affairs of Ukraine in Kharkiv Region			
QF.57-5.8-01.00. 1	Label for object	Version	1
		Page	41 of 1

Object No. 19
Conclusion No. 532/2014 of 04.03.215
 Package No. 19
 Object description: pair of ladies' black ankle boots (provided by Senior Forensic Investigator, investigations department of the Security Service of Ukraine Kharkiv Regional directorate, Senior Lieutenant of Justice I.M. Babak as part of criminal proceedings No. 22014220000000305)

Name of expert: D.A. Karakurkchi
 Signature (signature) Date: 04.03.2015
 (imprint of FEAD FRC seal)

Danger category:
~~extremely dangerous~~
~~–dangerous~~
~~–somewhat dangerous~~
 - safe
~~DANGER: EXPLOSIVE~~

20) package No. 20

Forensic Research Center, Main Directorate of the Ministry of Internal Affairs of Ukraine in Kharkiv Region			
QF.57-5.8-01.00. 1	Label for object	Version	1
		Page	41 of 1

Object No. 20
Conclusion No. 532/2014 of 04.03.215
 Package No. 20
 Object description: ladies' black knit jumper (provided by Senior Forensic Investigator, investigations department of the Security Service of Ukraine Kharkiv Regional directorate, Senior Lieutenant of Justice I.M. Babak as part of criminal proceedings No. 22014220000000305)

Name of expert: D.A. Karakurkchi
 Signature (signature) Date: 04.03.2015
 (imprint of FEAD FRC seal)

Danger category:
~~extremely dangerous~~
~~–dangerous~~
~~–somewhat dangerous~~
 - safe
~~DANGER: EXPLOSIVE~~

21) package No. 21

Forensic Research Center, Main Directorate of the Ministry of Internal Affairs of Ukraine in Kharkiv Region			
QF.57-5.8-01.00. 1	Label for object	Version	1
		Page	41 of 1

Object No. 21
Conclusion No. 532/2014 of 04.03.215
 Package No. 21
 Object description: black-and-brown ladies' handbag (provided by Senior Forensic Investigator, investigations department of the Security Service of Ukraine Kharkiv Regional directorate, Senior Lieutenant of Justice I.M. Babak as part of criminal proceedings No. 22014220000000305)

Name of expert: D.A. Karakurkchi
 Signature (signature) Date: 04.03.2015
 (imprint of FEAD FRC seal)

Danger category:
~~extremely dangerous~~
~~–dangerous~~
~~–somewhat dangerous~~
 - safe
~~DANGER: EXPLOSIVE~~

22) package No. 22

Forensic Research Center, Main Directorate of the Ministry of Internal Affairs of Ukraine in Kharkiv Region			
QF.57-5.8-01.00. 1	Label for object	Version	1
		Page	41 of 1

Object No. 22
Conclusion No. 532/2014 of 04.03.215
 Package No. 22
 Object description: white plastic bag with man's shoes, socks and belt (provided by Senior Forensic Investigator, investigations department of the Security Service of Ukraine Kharkiv Regional directorate, Senior Lieutenant of Justice I.M. Babak as part of criminal proceedings No. 22014220000000305)

Name of expert: D.A. Karakurkchi
 Signature (signature) Date: 04.03.2015
 (imprint of FEAD FRC seal)

Danger category:
~~extremely dangerous~~
~~–dangerous~~
~~–somewhat dangerous~~
 - safe
~~DANGER: EXPLOSIVE~~

[seal:] Forensic Research Center No. 12 Kharkiv Region
 Main Directorate Ministry of Internal Affairs of Ukraine
 Forensic expert [signature]

D.A. Karakurkchi

23) package No. 23

Forensic Research Center, Main Directorate of the Ministry of Internal Affairs of Ukraine in Kharkiv Region			
QF.57-5.8-01.00. 1	Label for object	Version	1
		Page	42 of 1
Object No. 23 Conclusion No. 532/2014 of 04.03.215 Package No. 23 Object description: pair of blue jeans (provided by Senior Forensic Investigator, investigations department of the Security Service of Ukraine Kharkiv Regional directorate, Senior Lieutenant of Justice I.M. Babak as part of criminal proceedings No. 22014220000000305) Name of expert: D.A. Karakurkchi Signature (signature) Date: 04.03.2015 (imprint of FEAD FRC seal)			
<u>Danger category:</u> extremely dangerous –dangerous –somewhat dangerous - <u>safe</u> DANGER: EXPLOSIVE			

24) package No. 24

Forensic Research Center, Main Directorate of the Ministry of Internal Affairs of Ukraine in Kharkiv Region			
QF.57-5.8-01.00. 1	Label for object	Version	1
		Page	42 of 1
Object No. 24 Conclusion No. 532/2014 of 04.03.215 Package No. 24 Object description: pair of blue jeans, white short-sleeve T-shirt and grey jumper (provided by Senior Forensic Investigator, investigations department of the Security Service of Ukraine Kharkiv Regional directorate, Senior Lieutenant of Justice I.M. Babak as part of criminal proceedings No. 22014220000000305) Name of expert: D.A. Karakurkchi Signature (signature) Date: 04.03.2015 (imprint of FEAD FRC seal)			
<u>Danger category:</u> extremely dangerous –dangerous –somewhat dangerous - <u>safe</u> DANGER: EXPLOSIVE			

25) package No. 25

Forensic Research Center, Main Directorate of the Ministry of Internal Affairs of Ukraine in Kharkiv Region			
QF.57-5.8-01.00. 1	Label for object	Version	1
		Page	42 of 1
Object No. 25 Conclusion No. 532/2014 of 04.03.215 Package No. 25 Object description: gauze pad (provided by Senior Forensic Investigator, investigations department of the Security Service of Ukraine Kharkiv Regional directorate, Senior Lieutenant of Justice I.M. Babak as part of criminal proceedings No. 22014220000000305) Name of expert: D.A. Karakurkchi Signature (signature) Date: 04.03.2015 (imprint of FEAD FRC seal)			
<u>Danger category:</u> extremely dangerous –dangerous –somewhat dangerous - <u>safe</u> DANGER: EXPLOSIVE			

The expert conclusion is appended by an illustrative table, an expenses report and twenty-five packages containing investigated objects.

CONCLUSIONS

1. The objects retrieved during an inspection of the incident scene and submitted for investigation bear traces of blast products of the following explosive substances:

- based on trotyl (TNT) and hexogen (RDX) (investigated objects No. 2, 8, 9, 10, 12, 13.1, 13.2, 14, 16.1, 16.2, 16.3, 16.4, 16.5, 19, 22, and 25);
- based on trotyl (TNT) (investigated objects No. 3, 7, and 24).

[seal:] Forensic Research Center No. 12 Kharkiv Region
 Main Directorate Ministry of Internal Affairs of Ukraine
 Forensic expert [signature]

D.A. Karakurkchi

The explosive substance detonated may have contained metallic aluminum.

2. Around 21.38 on 11.09.2014, an SPM medium limpet mine with a delayed action VZD-1M fuze was detonated at the Stena bar (13 vul. Rymarska, Kharkiv). An SPM mine with a VZD-1M fuze is equipped with an MS brisant explosive charge of normal strength (57% hexogen (RDX), 19% trotyl (TNT), 17% aluminum, 7% phlegmatizer (ceresin)) of 1 kg in mass, which belongs to an industrially made category of ammunition. An SPM mine is an anti-object time-fuse incendiary mine intended for destroying movable and stationary items with metal parts and can be used on land and under water.

3. A delayed action VZD-1M fuze was used to detonate the SPM mine, which was installed the mine casing, activated with a time delay and working in a standard way.

4. No. specialist professional knowledge, education or military mine, explosive or engineering training is required to use an SPM mine with a VZD-1M fuze. The procedure and rules of operation can be obtained independently from freely available open sources. It should be noted that the period between activating a VZD-1M fuze and the moment of explosion can take from tens of minutes to several days, depending on the number of the metal element (time delay mechanism) and the ambient temperature. Therefore, in breach of the rules for preparing and using this type of mines, it is possible to activate a VZD-1M fuze before the mine is installed on site.

ILLUSTRATIVE TABLE

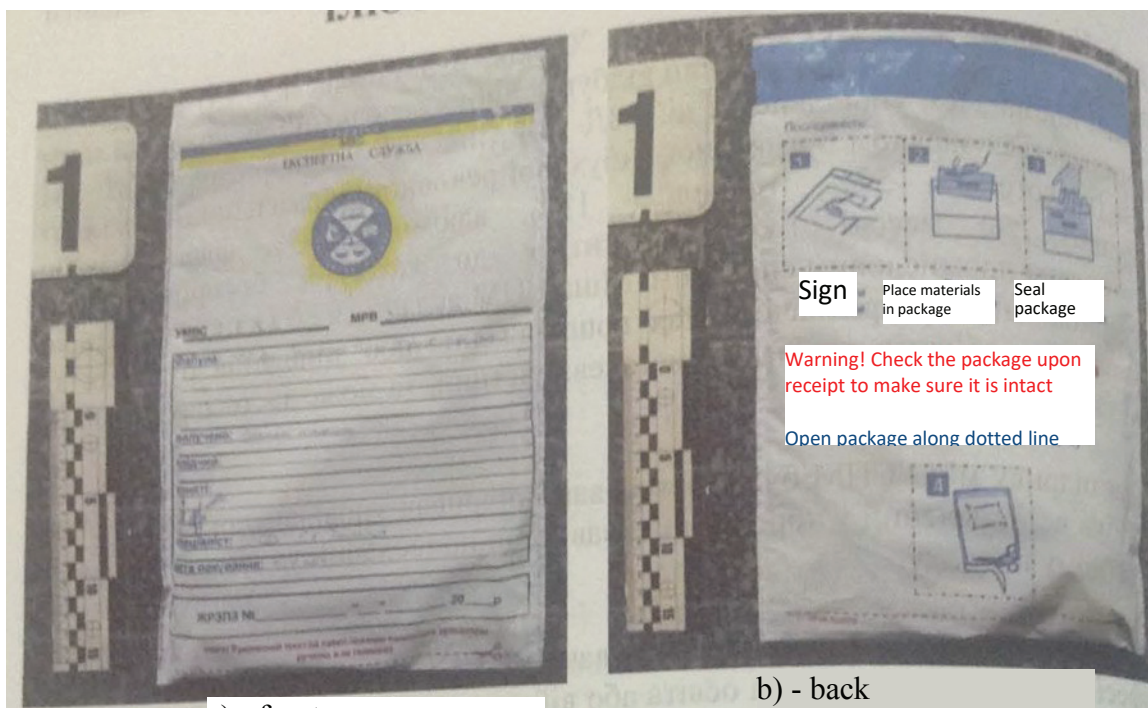

a) - front

b) - back

Figure 1 – View of package No. 1 (bag No. 1784474)



a) – front

b) – back

Figure 2 – View of package No. 2 (bag No. 1784474)



Figure 3 – View of package No. 3 (bag No. 0508138)



Figure 4 – View of package No. 4 (bag No. 1784473)

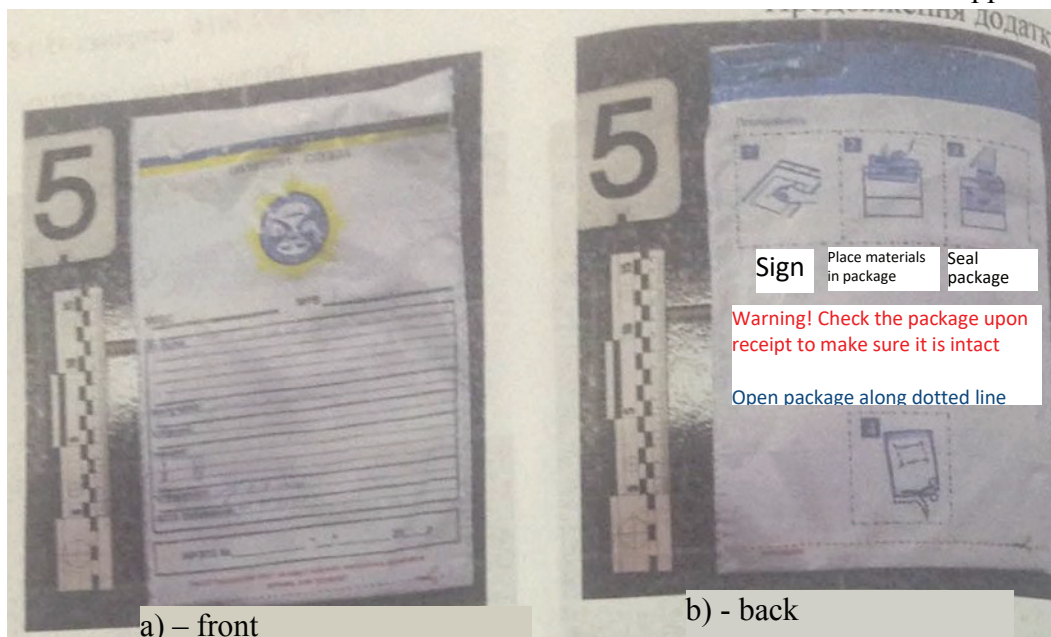
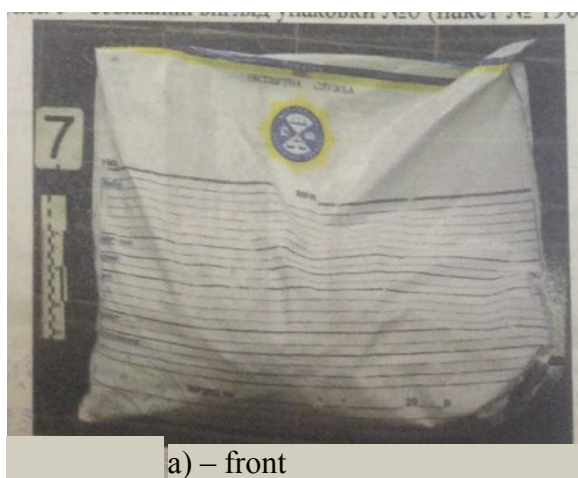
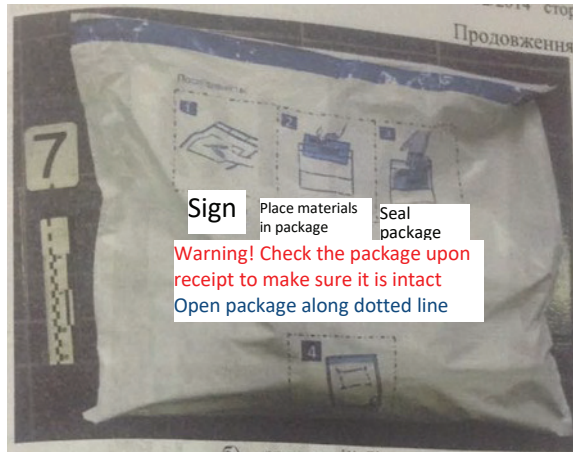

Figure 5 – View of package No. 5 (bag No. 1784476)



Figure 6 – View of package No. 6 (bag No. 1968523)





b) – back

Figure 7 – View of package No. 7 (bag No. 1968085)

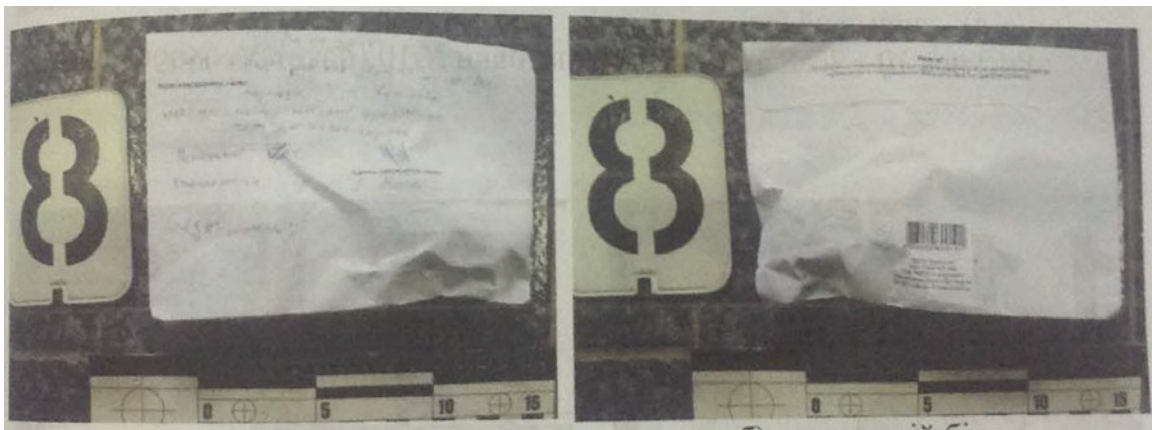

a) – front

b) – back

Figure 8 – View of package No. 8



a) – front

b) - back

Figure 9 – View of package No. 9 (bag No. 1784476)



a) – front

b) - back

Figure 10 – View of package No. 10 (bag No. 0509977)



a) – front

b) – back

Figure 11 – View of package No. 11 (bag No. 0509968)



Figure 12 – View of package No. 12 (bag No. 0509969)



Figure 13 – View of package No. 13 (bag No. 0509979)



Figure 14 – View of package No. 14 (bag No. 1158952)



Figure 15 – View of package No. 15 (bag No. 1158955)



a) – front

a) – front

b) – back

Figure 16 – View of package No. 16 (bag No. 1158953)



a) – front

b) – back

Figure 17 – View of package No. 17 (bag No. 0508137)



Figure 18 – View of package No. 18 (bag No. 1784476)



Figure 19 – View of package No. 19 (bag No. 1784476)



Figure 20 – View of package No. 20 (bag No. 1784476)



Figure 21 – View of package No. 21 (bag No. 1784476)



Figure 22 – View of package No. 22 (bag No. 1784476)



Figure 23 – View of package No. 23 (bag No. 1784476)



Figure 24 – View of package No. 24 (bag No. 1784476)



Figure 25 – View of package No. 25 (bag No. 1784476)



a) – front

b) – back

Figure 26 – View of the fabric fragment retrieved from package No. 1:
investigated object No. 1

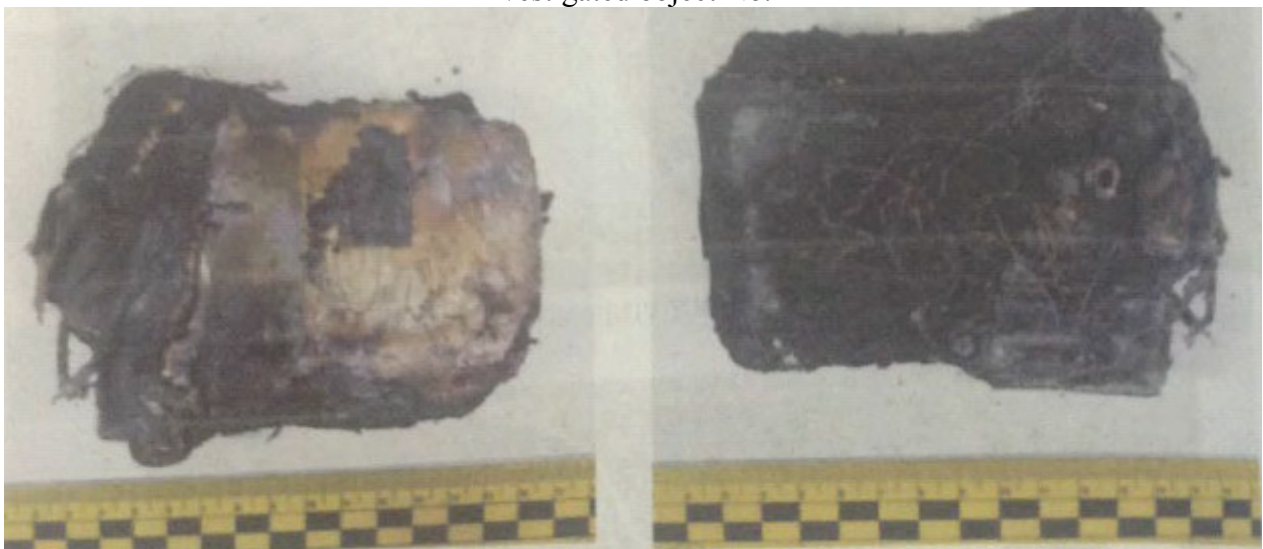

a) – front

b) - back

Figure 27 – View of the wallet retrieved from package No. 2:
investigated object No. 2



Figure 28 – View of investigated object No. 2 as opened



Figure 29 – View of cards and money retrieved from investigated object No. 2



Figure 30 – View of PrivatBank cards retrieved from investigated object No. 2 (front)

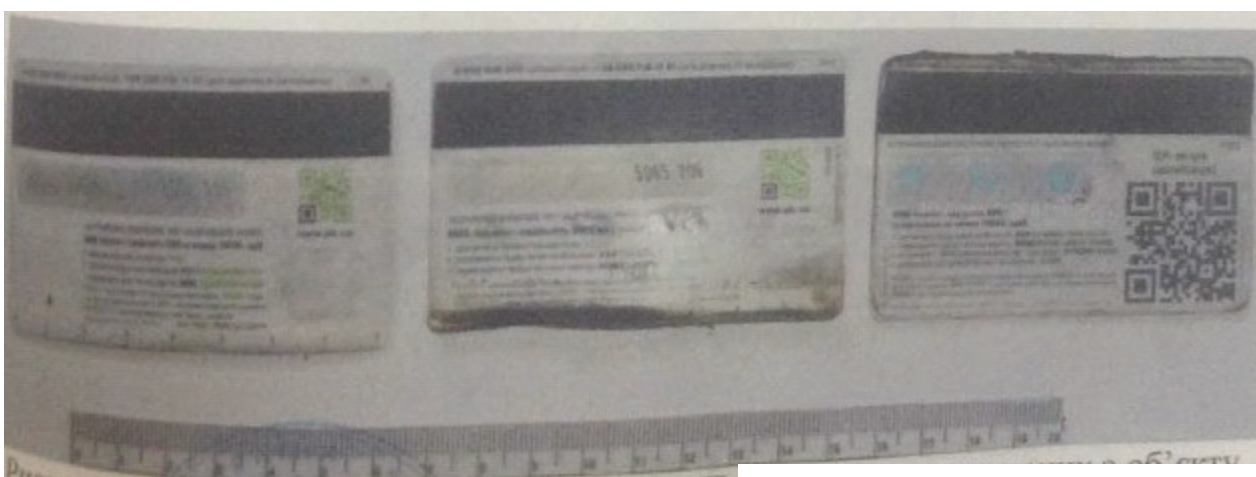

Figure 31 – View of PrivatBank cards retrieved from investigated object No. 2 (back)

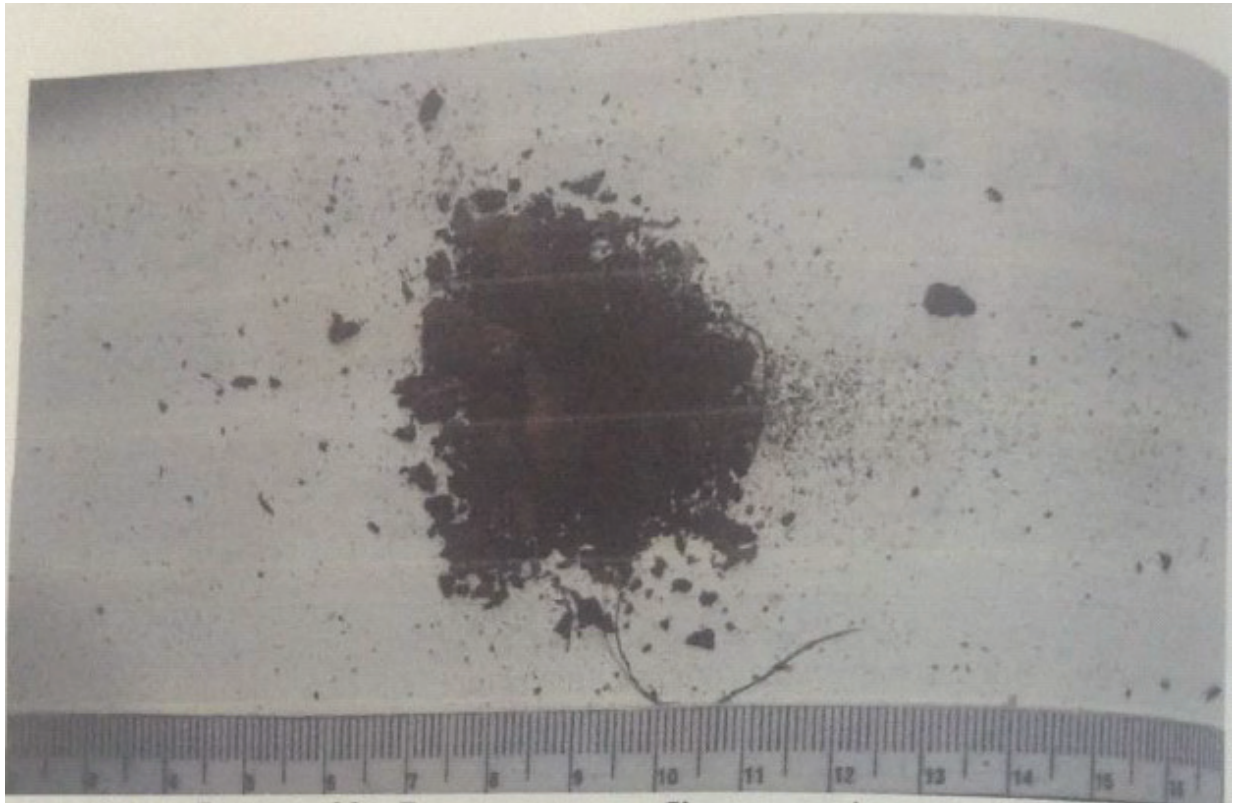

Figure 32 – View of debris from investigated object No. 2



Figure 33 – View of bank notes retrieved from package No. 3:
group of investigated objects No. 3



a) – front

b) – back

Figure 34 – View of Lenovo laptop retrieved from package No. 4:
investigated object No. 4



Figure 35 – View of Lenovo laptop retrieved from package No. 4 as opened - investigated object No. 4



Figure 36 – View of emblems retrieved from package No. 5 -
group of investigated objects No. 5

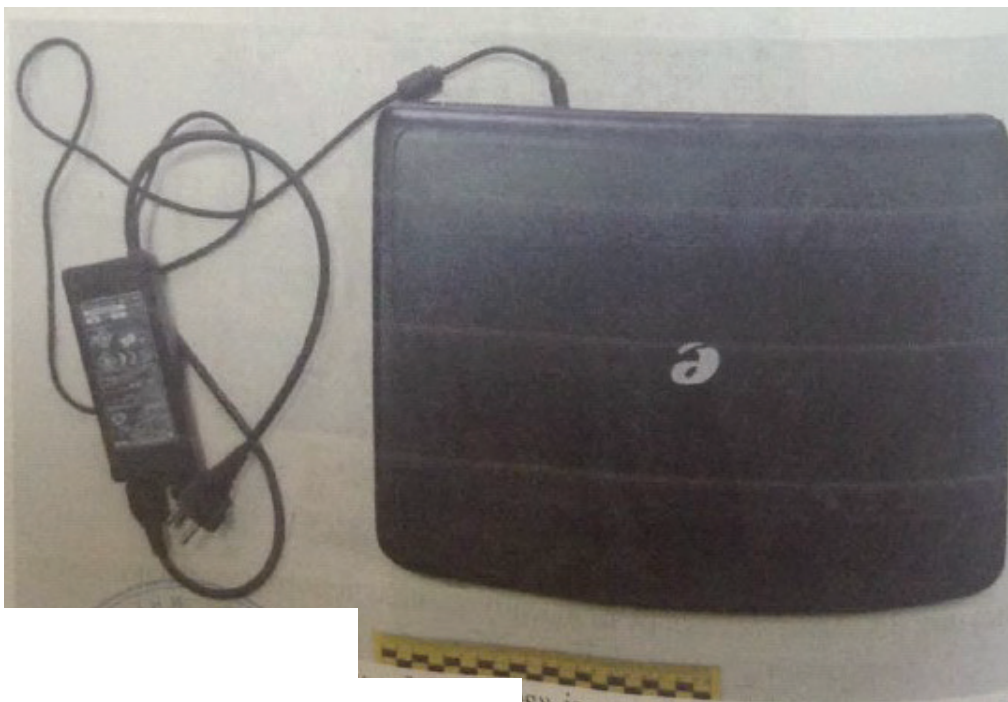

Figure 37 – View of eMachines laptop with charger retrieved from package No. 6
(view of top cover)



Figure 38 – View of eMachines laptop with charger retrieved from package No. 6
(view of bottom cover)

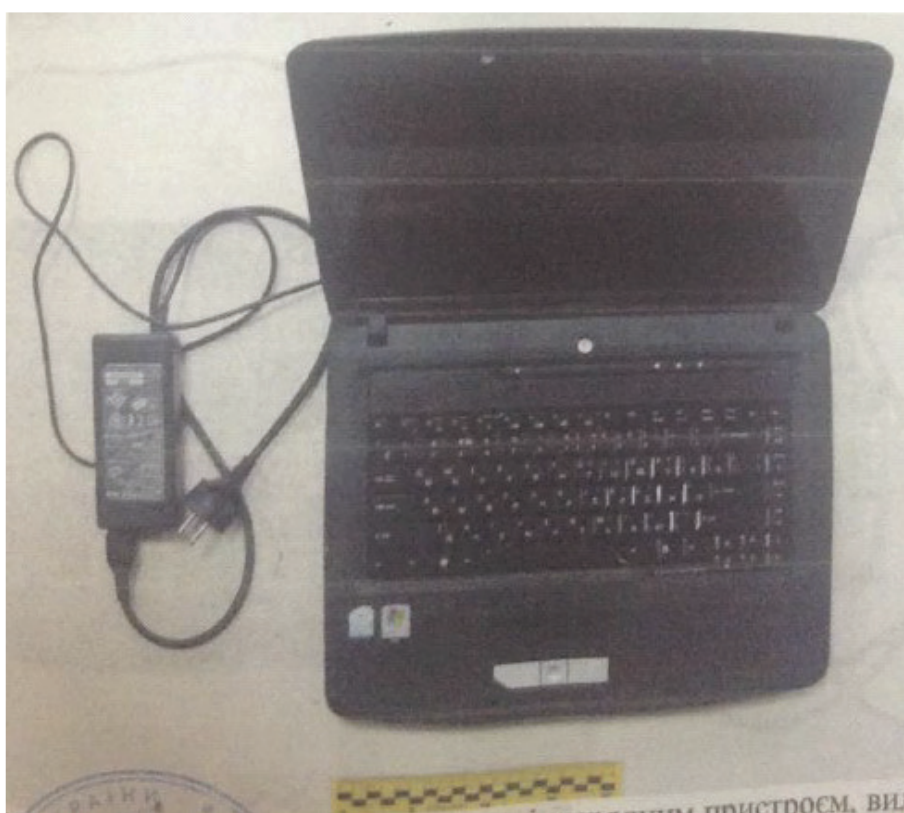

Figure 39 – View of eMachines laptop with charger retrieved from package No. 6
(as opened)

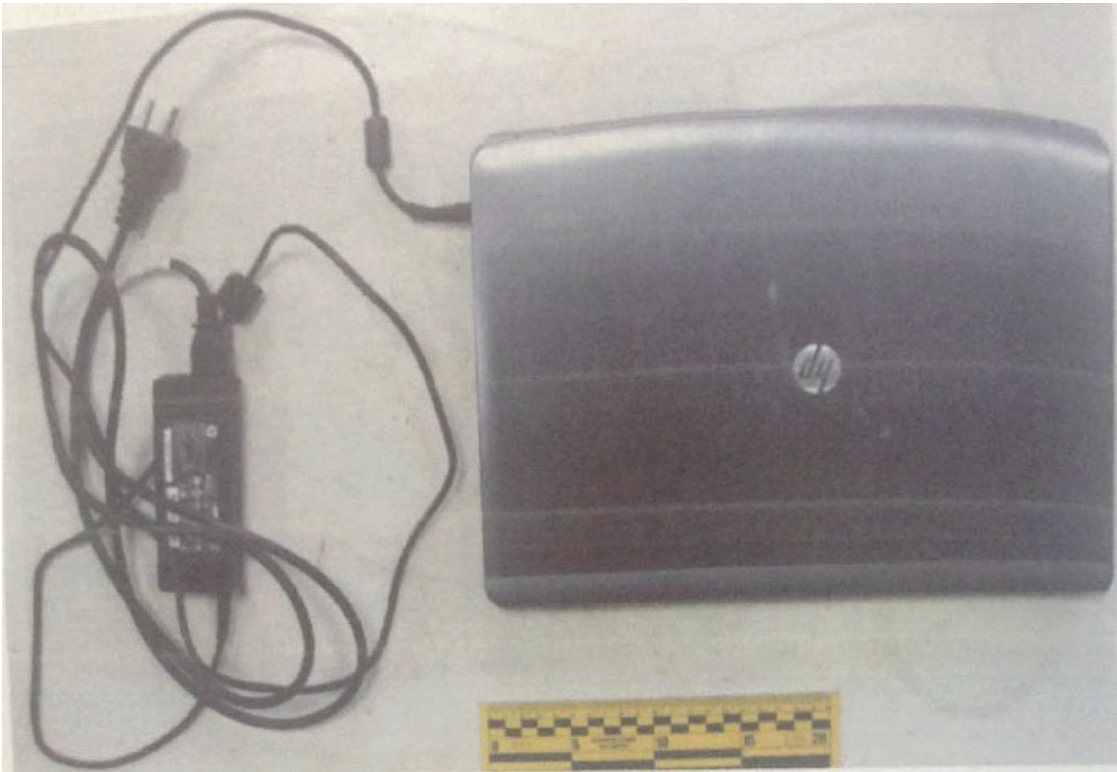

Figure 40 – View of HP laptop with charger retrieved from package No. 6
(view of top cover)

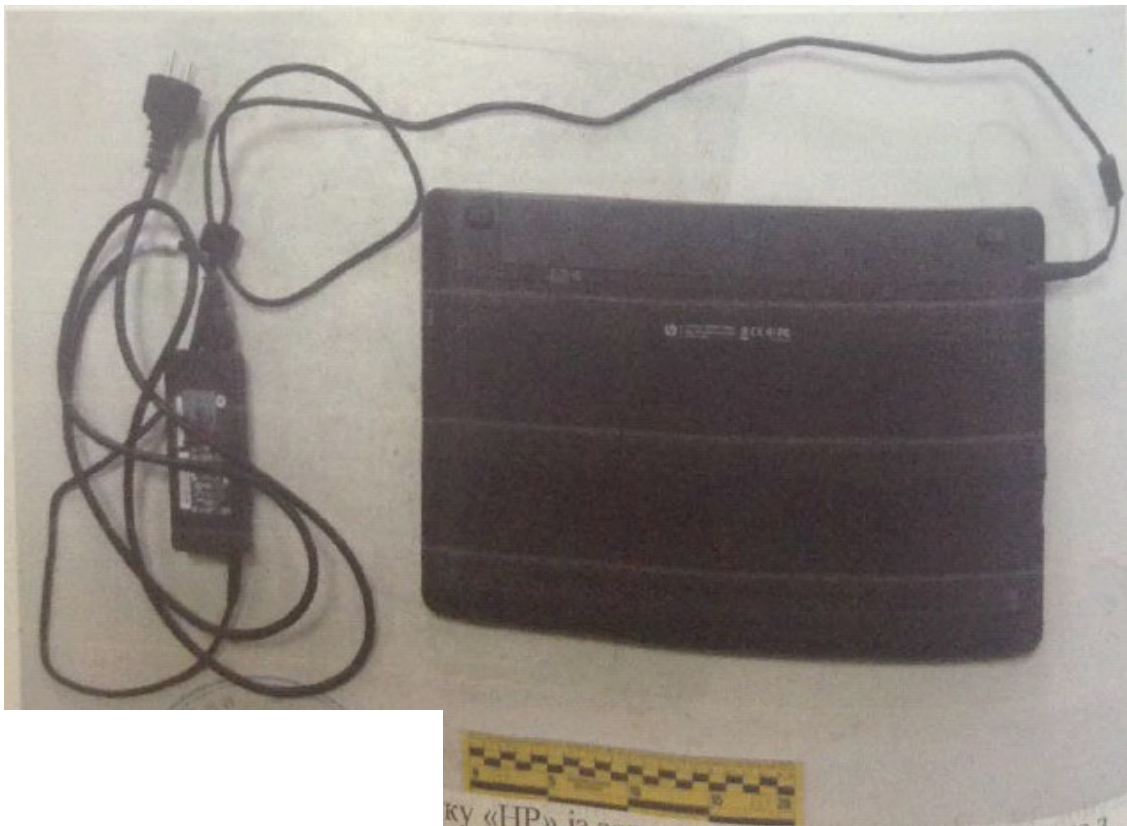

Figure 41 – View of HP laptop with charger retrieved from package No. 6
(view of bottom cover)



Figure 42 – View of HP laptop with charger retrieved from package No. 6
(as opened)



Figure 43 – View of HP laptop without charger retrieved from package No. 6
(view of top cover)



Figure 44 – View of HP laptop without charger retrieved from package No. 6
(view of bottom cover)



Figure 45 – View of HP laptop without charger retrieved from package No. 6
(as opened)

[seal:] Forensic Research Center No. 12 Kharkiv Region
Main Directorate Ministry of Internal Affairs of Ukraine
Forensic expert [signature]

D.A. Karakurkchi



a) – front

b) – back

Figure 46 – View of jacket retrieved from package No. 7 -
investigated object No. 7

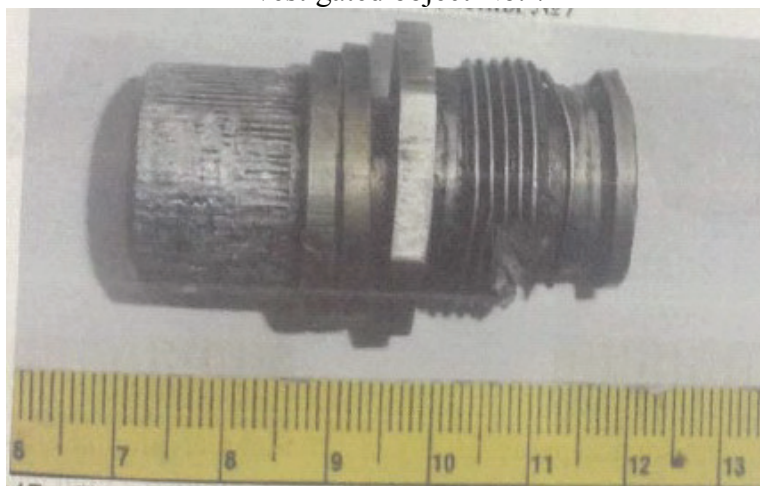

Figure 47 – View of metal object retrieved from package No. 8 -
investigated object No. 8



Figure 48 – View of investigated object No. 8 taken apart



a) view of cap

b) view of crossed sections to fit the metal element and cutter

c) view of bottom side with remnants of firing pin and metal element

Figure 49 – View of characteristic features of investigated object No. 8 when taken apart

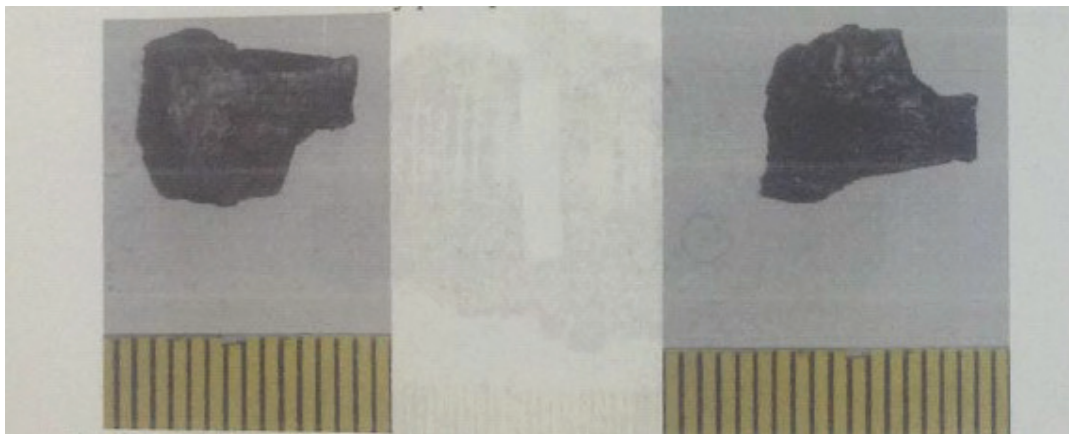

a) view of outer surface

b) view of inner surface

Figure 50 – View of metal item retrieved from package No. 9 investigated object No. 9



Figure 51 – View of gauze pad retrieved from package No. 10 investigated object No. 10



a) front



b) back

Figure 52 – View of fabric fragment retrieved from package No. 11
investigated object No. 11

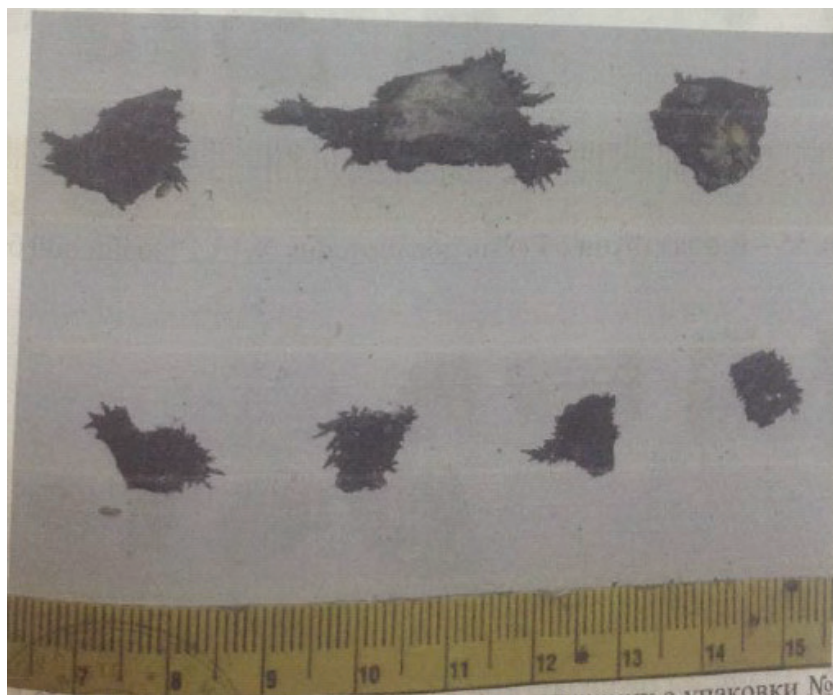

Figure 53 – View of metal fragments retrieved from package No. 12
group of investigated objects No. 12



Figure 54 – View of metal fragments retrieved from package No. 13

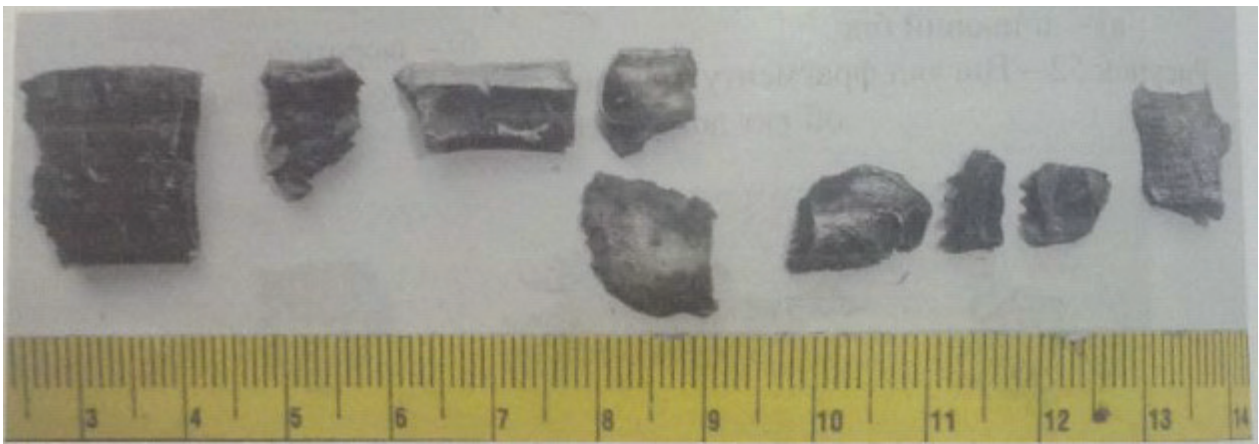

Figure 55 – View of group of investigated objects No. 13.1 (outer surface)



Figure 56 – View of group of investigated objects No. 13.1 (inner surface)



Figure 57 – View of two metal fragments with characteristic structural features from group of investigated objects No. 13.1 (close-up)



Figure 58 – View of investigated object No. 13.2

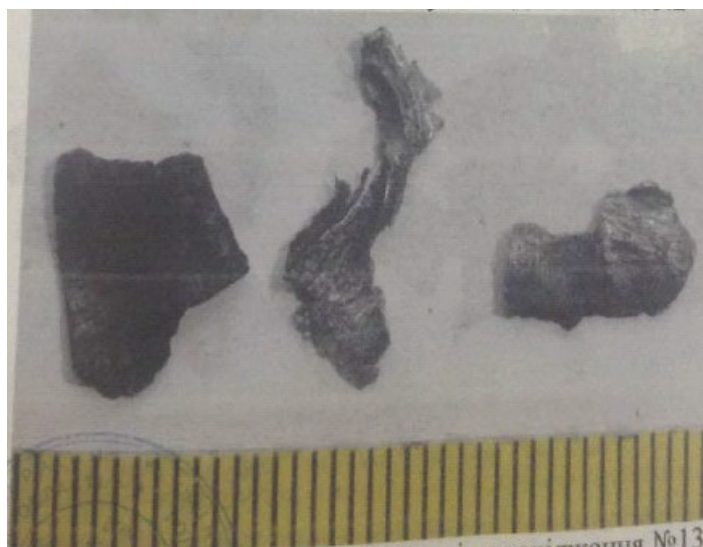

Figure 59 – View of group of investigated objects No. 13.3



Figure 60 – View of investigated object No. 13.4



Figure 61 – View of group of investigated objects No. 13.5

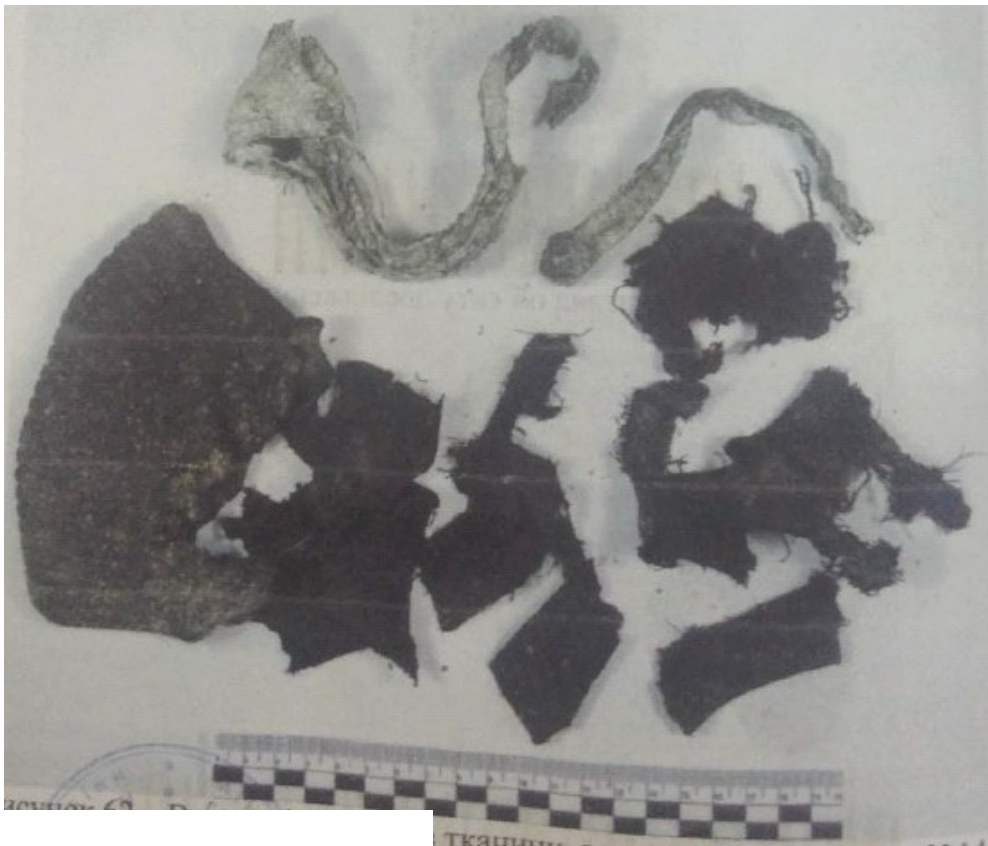

Figure 62 – View of fabric fragments retrieved from package No. 14 –
investigated object No. 14

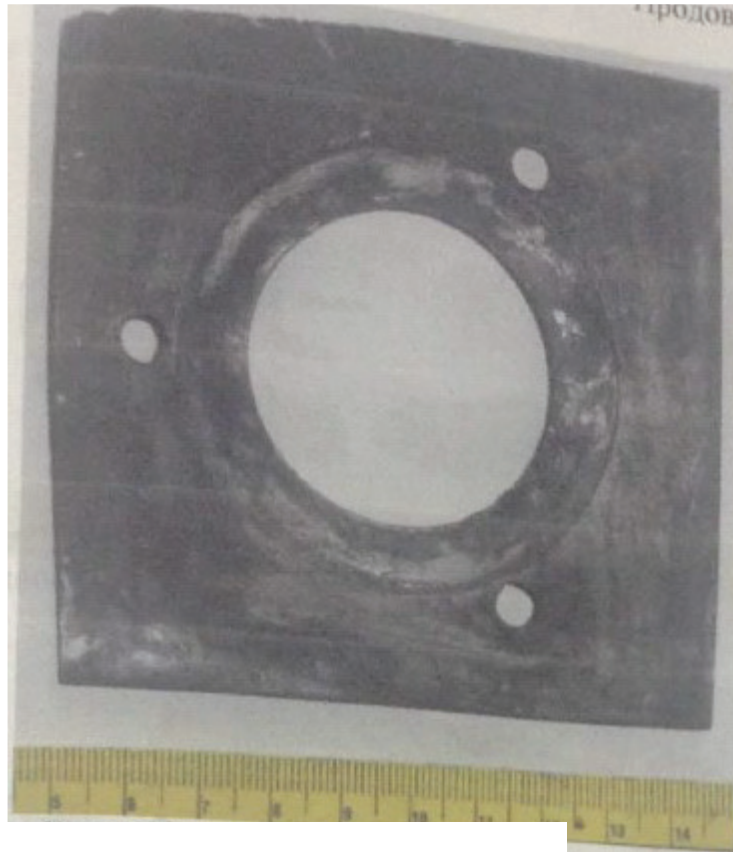

Figure 63 – View of metal fragment retrieved from package No. 15 –
investigated object No. 15



Figure 64 – View of metal fragments retrieved from package No. 16



Figure 65 – View of group of investigated objects No. 16.1 (outer surface)



Figure 66 – View of group of investigated objects No. 16.1 (inner surface)

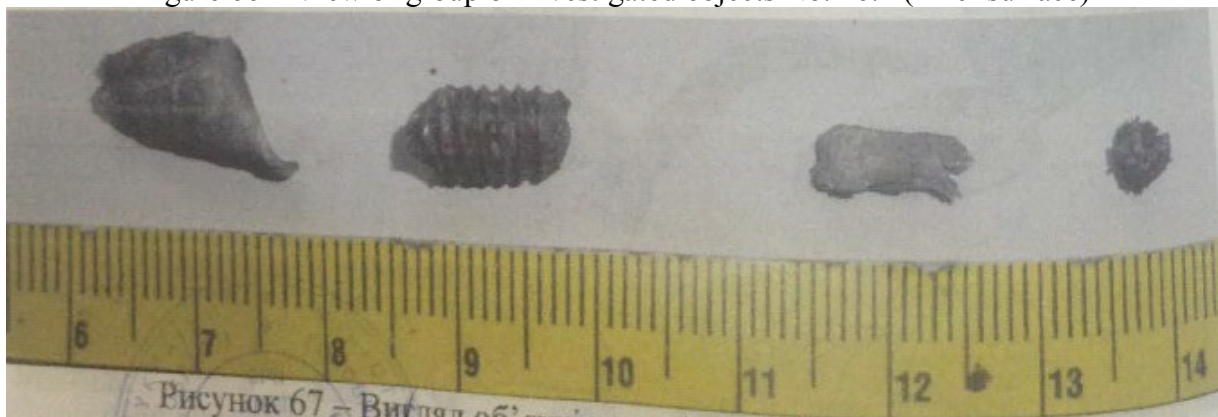

Figure 67 – View of investigated objects No. 16.2 – 16.5 (from left)

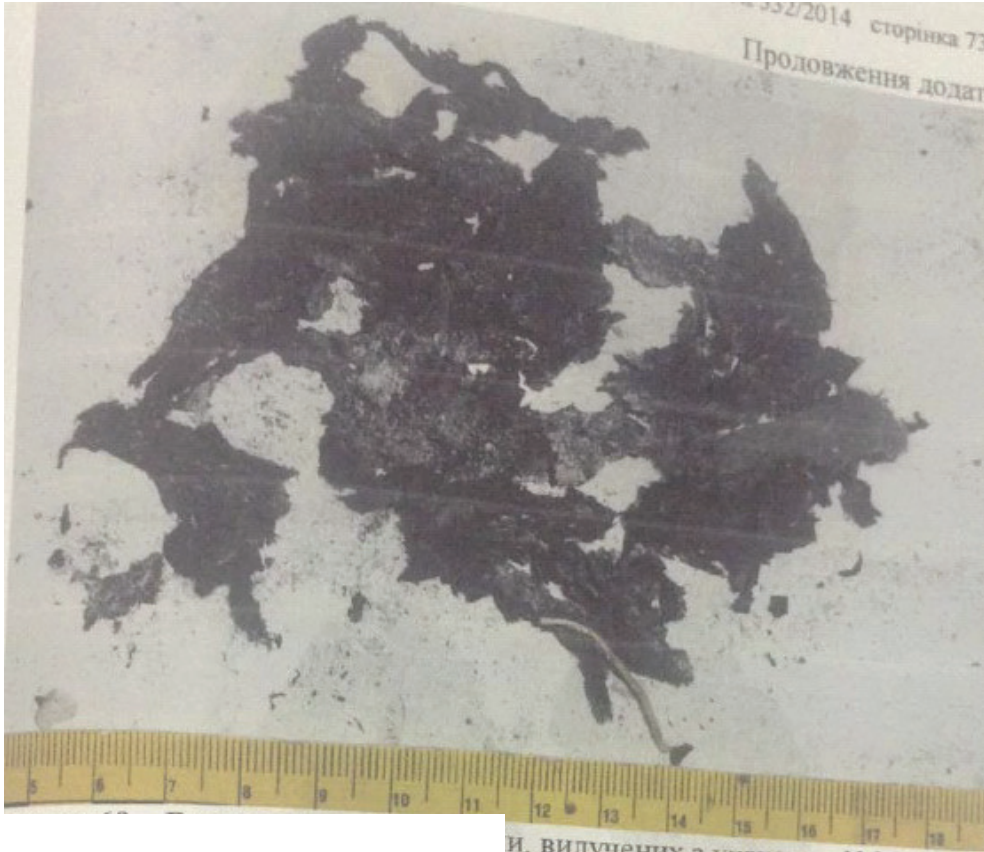

Figure 68 – View of torn fabric fragments retrieved from package No. 16 – group of investigated objects No. 16.6



Figure 69 – View of fabric fragment retrieved from package No. 17 – investigated object No. 17



Figure 70 – View of clothes retrieved from package No. 18 –
group of investigated objects No. 18



Figure 71 – View of shoes retrieved from package No. 19 –
group of investigated objects No. 19



Figure 72 – View of clothes retrieved from package No. 20 –
investigated object No. 20



Figure 73 – View of handbag retrieved from package No. 21 –
investigated object No. 21



Figure 74 – View of items retrieved from package No. 22 –
group of investigated objects No. 22



Figure 75 – View of jeans retrieved from package No. 23 –
investigated object No. 23



Figure 76 – View of items retrieved from package No. 24 – group of investigated objects No. 24



Figure 77 – View of damage and brownish-red deposits on jeans from group of investigated objects No. 24



Figure 78 – View of gauze pad retrieved from package No. 25 – investigated object No. 25



Figure 79 – View of reference example of an SPM mine with VZD-1M fuze (view of inner casing structure with the cover off)



Figure 80 – View of additional detonator cup in SPM mine casing (close-up)

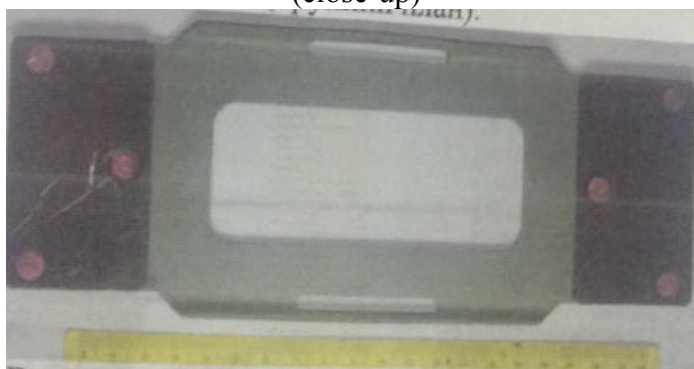

Figure 81 – View of reference example – steel plate for an SPM mine (view of the side connecting to magnets)

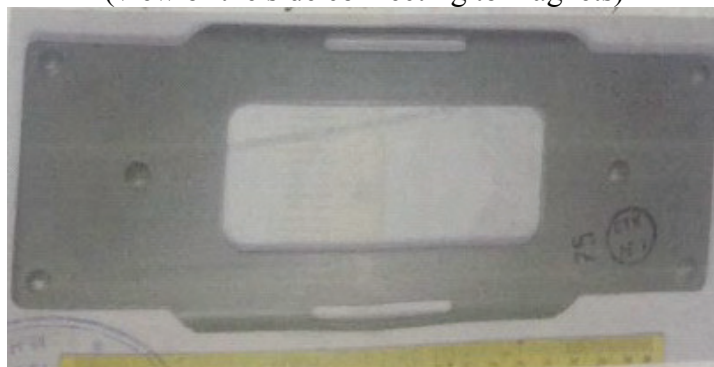
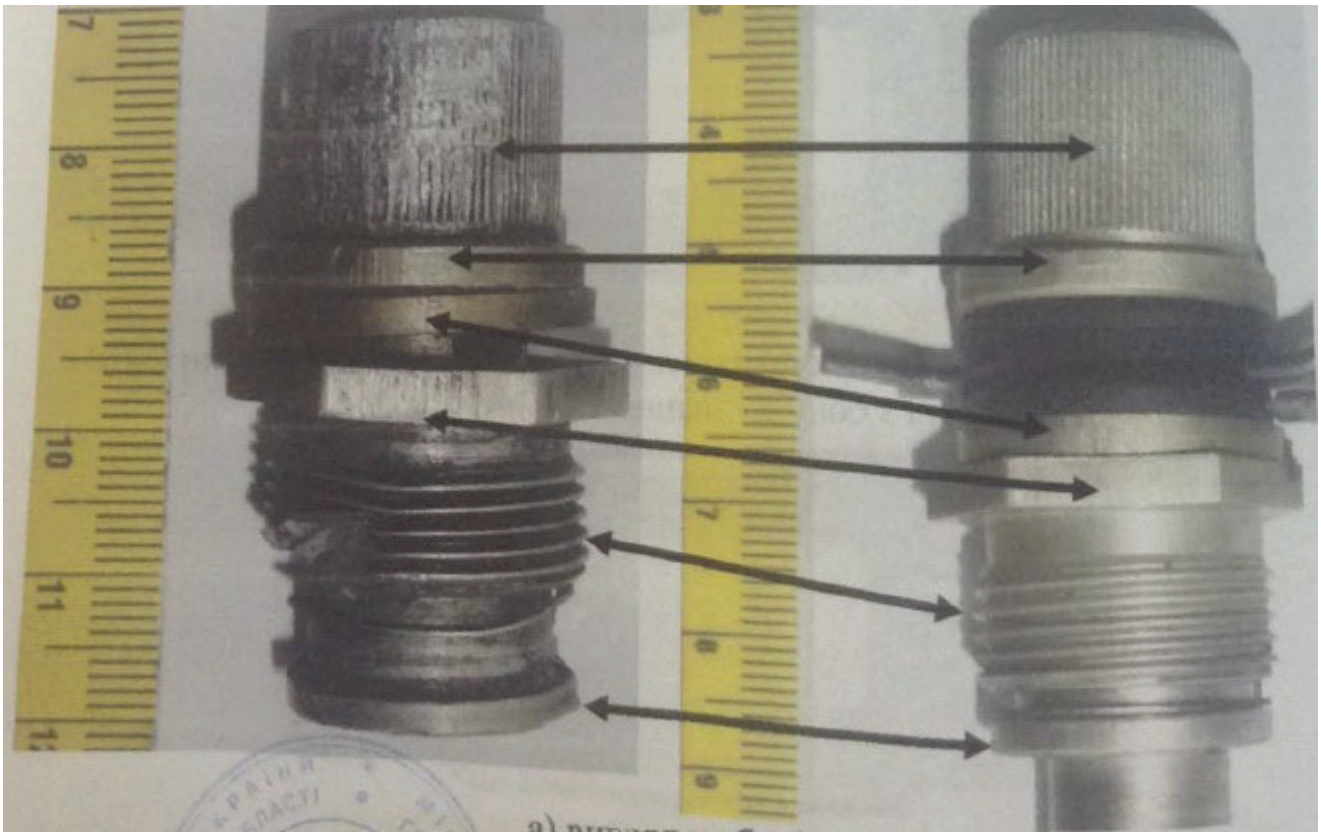

Figure 82 – View of reference example – steel plate for an SPM mine (view of outer surface)



Figure 83 – View of reference example – VZD-1M fuze



a) assembled state

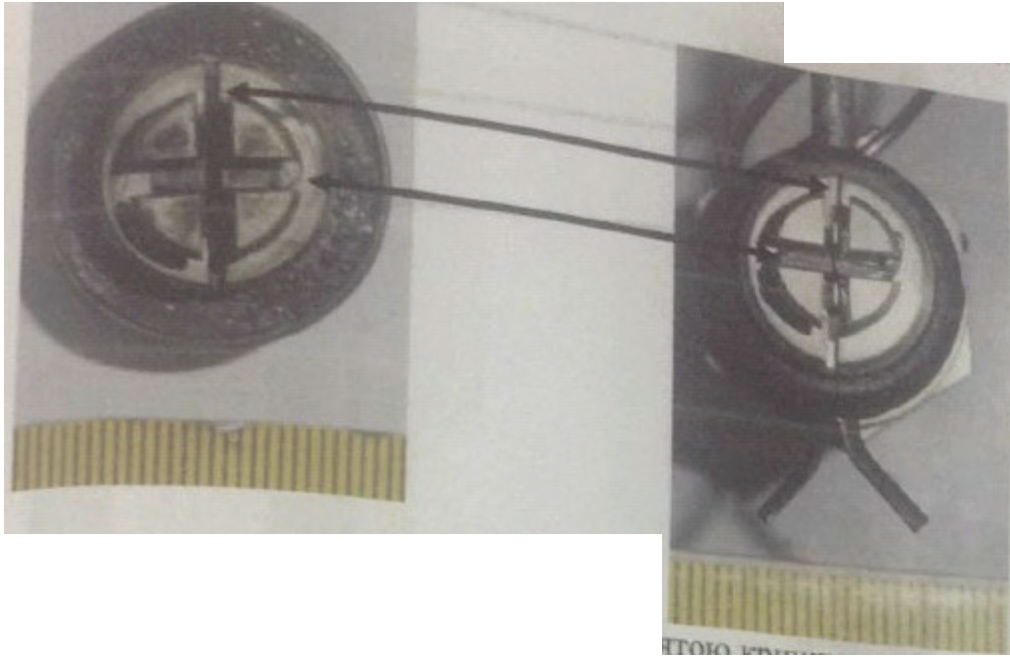

b) top side with the cover off

Figure 84 – Comparative photo of investigated object No. 8 (left) with VZD-1M fuze (right). Arrows point to shared characteristics.



Figure 85 – Comparative photo of group of investigated objects No. 13.1 (left) with the external end of a cup (with dent to fit a wrench) for fitting a fuze from the mine casing (right). Arrows point to shared characteristics.

[seal:] Forensic Research Center No. 12 Kharkiv Region
Main Directorate Ministry of Internal Affairs of Ukraine
Forensic expert [signature]

D.A. Karakurkchi

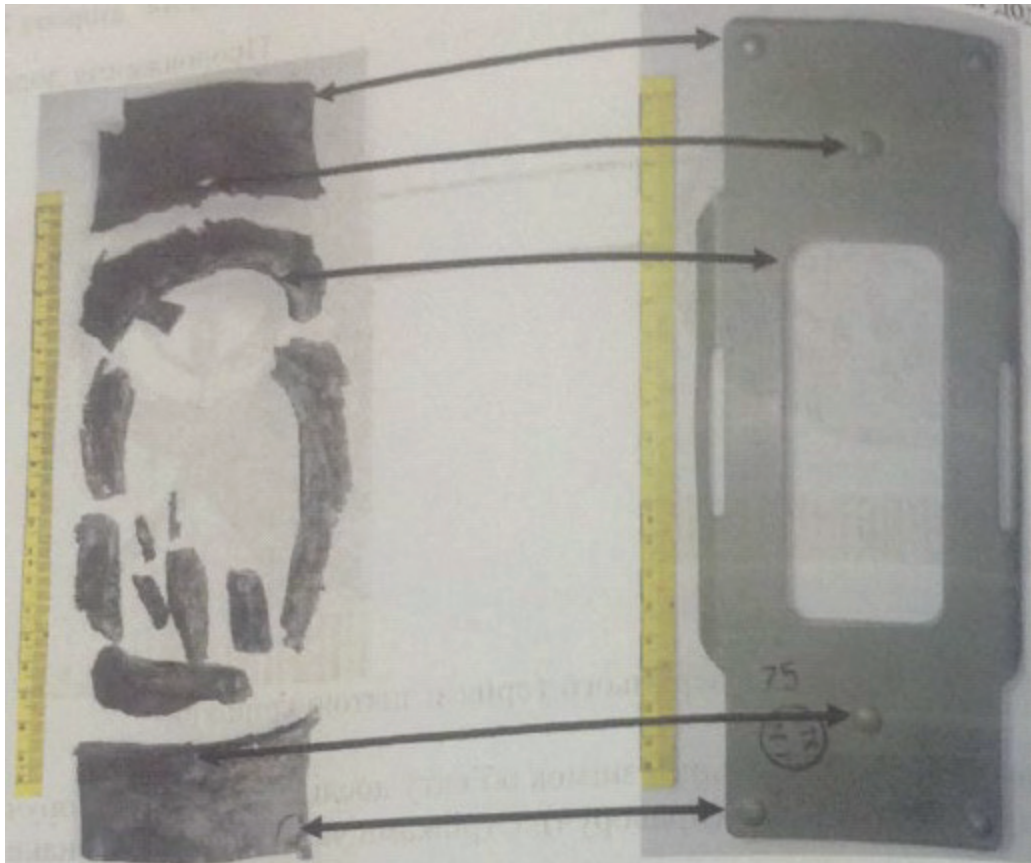

a) external surface

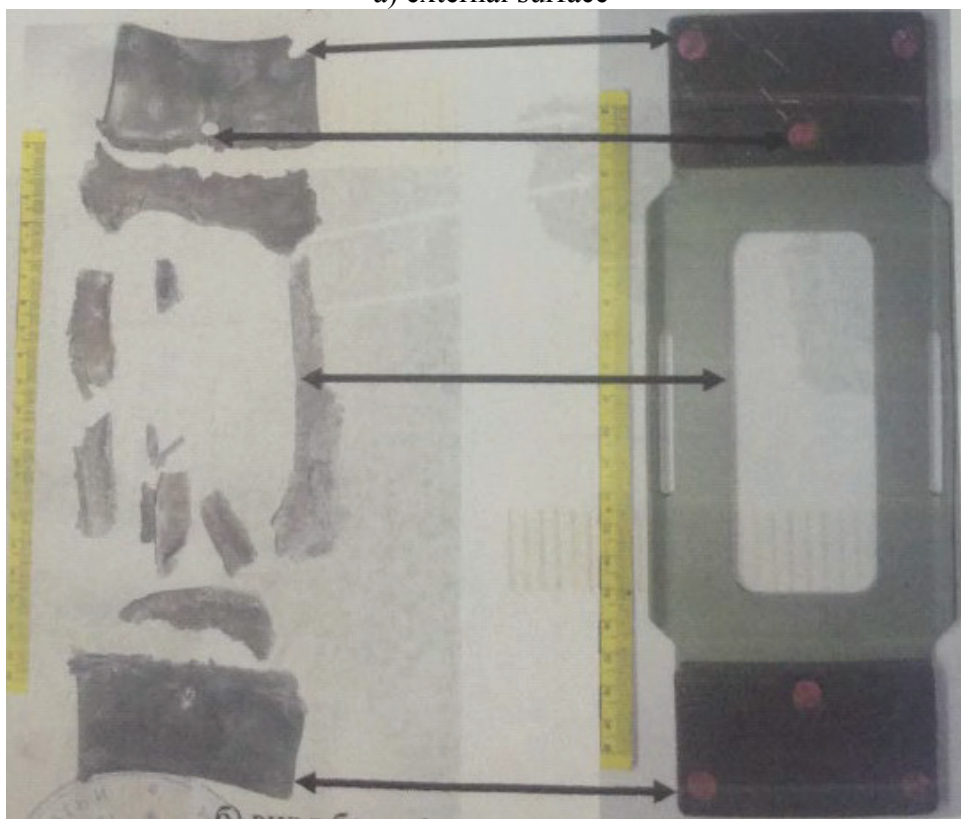

b) side connecting to magnets

Figure 86 – Comparative photo of group of investigated objects No. 16.1 (left) with steel plate for SPM mine (right). Arrows point to shared characteristics.

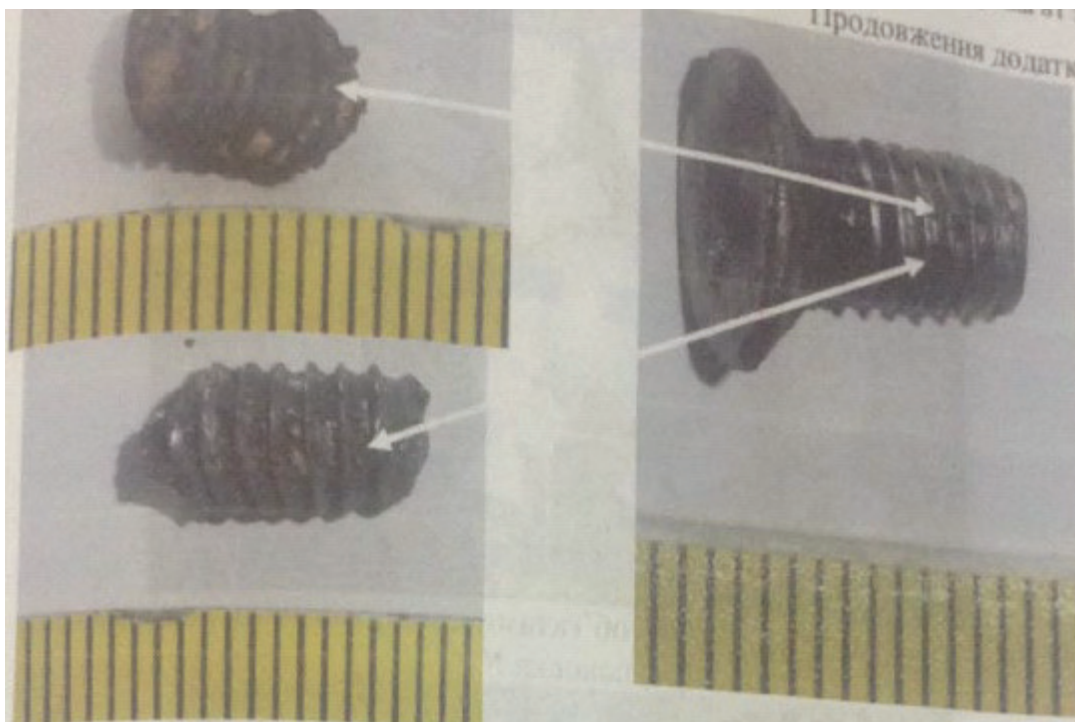

Figure 87 – Comparative photo of group of investigated objects No. 13.2 and 16.3 (left) with fixing bolt from the cover of SPM mine casing (right). Arrows point to shared characteristics.



Figure 88 – View of bags with investigated objects prior to handover to client
(package No. 1 – No. 7)



Figure 89 – View of bags with investigated objects prior to handover to client
(package No. 8 – No. 17)



Figure 90 – View of bags with investigated objects prior to handover to client
(package No. 18 – No. 23)



Figure 91 – View of bags with investigated objects prior to handover to client
(package No. 24, No. 25)

MINISTRY OF INTERNAL AFFAIRS OF UKRAINE
MAIN DIRECTORATE OF THE MINISTRY OF INTERNAL AFFAIRS OF UKRAINE
IN KHARKIV REGION

FORENSIC RESEARCH CENTER

34 vul.Kovtuna, Kharkiv

Tel. (057)721-23-39

vvtptd_kharkov@ukr.net

NOTE

on expenses incurred for conducting forensic explosive analysis No. 532/201 of 04.03.2015 as part of criminal proceedings No. 22014220000000305.

Customer: senior forensic investigator, Senior Lieutenant of Justice I.M. Babak of the investigations department at the Kharkiv Regional directorate of the Security Service of Ukraine.

No. of expert hours	Degree of analysis complexity	Cost of 1 expert hour, hryvnia, without VAT	Expenses incurred during analysis
1	2	3	4
82	special complexity	92.33	7571.06
Total			7571.06

Charge code 24060300, account No. 31419544700005

Bank code 37999680 MFO 851011

Remote bank access, Komintern district in Kharkiv

**Head of fire forensics sector,
forensic fire and explosives analysis department,**

Forensic Research Center

Kharkiv Region Main Directorate

Ministry of Internal Affairs of Ukraine

Police Lieutenant-Colonel

[signature]

D.A. Karakurkchi

**Head of explosive forensics sector,
forensic fire and explosives analysis department,**

Forensic Research Center

Kharkiv Region Main Directorate

Ministry of Internal Affairs of Ukraine

Police Lieutenant-Colonel

[signature]

I.V. Vislov

[seal: Forensic Research Center No. 12 Kharkiv Region
Main Directorate Ministry of Internal Affairs of Ukraine]

Forensic expert [signature]

D.A. Karakurkchi

Annex 119

Administrative Directorate of the General Staff of the Armed Forces of Ukraine
Letter No. 300/1/C/1917 (11 April 2015)

This document has been translated from its original language into English, an official language of the Court, pursuant to Rules of the Court, Article 51.

Pursuant to Rules of the Court Article 51(3), Ukraine has translated only an extract of the original document constituting this Annex. In further compliance with this Rule, Ukraine has provided two certified copies of the full original-language document



**MINISTRY OF DEFENSE OF UKRAINE
GENERAL STAFF OF THE ARMED FORCES OF
UKRAINE**

6 Povitroflotsky Prospect, Kyiv, 03168. Phone: (044) 226-26-56. Fax: (044) 226-26-56

Email: kabmin_doc@mil.gov.ua

Code in the Uniform Register of Businesses and Organizations of Ukraine: 22991050

_____ No. _____

Foreign Ministry of Ukraine

Re: No. _____

In pursuance of Instruction No. 02-01/2948 of October 15, 2014 issued by the Ukrainian Presidential Chief of Staff, presented herewith are informational reference materials pertaining to the body of evidence for the presence of foreign military groups in Ukrainian territory, to be used in raising the awareness of Ukrainian society and international partners more actively and in the future lawsuits to be filed by Ukraine with the relevant international courts.

Attachment: above-mentioned information on 2 pages, unclassified, for the specified recipient only

Acting First Deputy Chief
of the General Staff of the Armed Forces of Ukraine

Major General

[Signature]

V.M. NAZAROV

FOREIGN MINISTRY OF UKRAINE
DEPARTMENT OF THE GENERAL SECRETARIAT
Incoming Ref. No. 32618
April 16, 2015

Administrative Directorate of the General Staff of
the Armed Forces of Ukraine

No. 300/1/C/1917 of April 11, 2015

19:44:20 Pages: 1/2



01437288056594975232

D.S. Pasko, 454-40-78

000679*

Order 50-2015

INFORMATIONAL REFERENCE MATERIALS

pertaining to the body of evidence for the direct invasion by foreign military groups into Ukrainian territory

I. Regarding the chronology of the crossing of the state border of Ukraine by personnel, weapons, and military vehicles of the Armed Forces of the Russian Federation

No.	Date	Border crossing point crossed	Point of destination (crossing)	Number of convoys	Number of vehicles (personnel)
1.	April 9	DMYTRIVKA	In the direction of STEPANIVKA	1	20 KamAZ trucks with munitions and ammo
2.	April 9	USPENKA	ALCHEVSK	1	122-mm GRAD multiple rocket launcher, 17 trucks towing D-30 cannon mounted on trailers, and a tanker truck
3.	April 7	from the occupied territory of Ukraine, LUHANSK-IZVARYNE	To the Russian Federation	1	18 trucks (empty);
4.	April 07	from the occupied territory of Ukraine, DMYTRIVKA	To the Russian Federation		40 trucks.
5.	April 5	From the Russian Federation, IZVARINO	in the direction of LUHANSK		40 military vehicles, including 10 tanks
6.	April 4-6	DMYTRIVKA	STEPANIVKA	and	10, BTR armored personnel carriers, 30 BMD infantry fighting vehicles, and 25 trucks carrying personnel
7.	April 4-6	STEPANIVKA	1		40 trucks (all of them empty) crossed into the territory of the Russian Federation
8.	April 5	IZVARYNE	LUHANSK	1	up to 18 units (including up to 3 tanks and up to 15 armored fighting vehicles; type to be updated).
9.	April 4	From the Russian Federation	AMVROSIYIVKA railway station	Train	a train carrying ammunition (17 freight cars) and military vehicles (4 KShM command vehicles and 2 radio stations mounted on KamAZ trucks, 2 power generators mounted on URAL trucks).
10.	April 4	IZVARYNE	KRASNODON-SVERDLOVSK	1	20 tanks and 3 tanker trucks;
11.	April 4	IZVARYNE	KRASNODON-LUHANSK	1	7 BMP infantry fighting vehicles, 3 tanks, 2 trucks carrying personnel and munitions.
12.	April 4	IZVARYNE	KRASNODON-LUHANSK	1	Military vehicles, including tanks, over 15 armored fighting vehicles, trucks and tanker trucks (the number of vehicles to be updated).

No.	Date	Border crossing point crossed	Point of destination (crossing)	Number of convoys	Number of vehicles (personnel)
13.	April 3	From the Russian Federation	DEBALTSEVE	Train	flatcars under canopies
14.	April 3	DOVZHANSKE	SVERDLOVSK		9 tanks, 3 122-mm GRAD multiple rocket launchers

Acting Chief
of the Main Command Center
of the Armed Forces of Ukraine

Major General

[Signature]

O.S. SYRSKYI

Annex 120

Administrative Directorate of the General Staff of the Armed Forces of Ukraine
Letter No. 300/1/C/2056 (18 April 2015)

This document has been translated from its original language into English, an official language of the Court, pursuant to Rules of the Court, Article 51.

Pursuant to Rules of the Court Article 51(3), Ukraine has translated only an extract of the original document constituting this Annex. In further compliance with this Rule, Ukraine has provided two certified copies of the full original-language document



MINISTRY OF DEFENSE OF UKRAINE
GENERAL STAFF OF THE ARMED FORCES OF
UKRAINE

6 Povitroflotsky Prospect, Kyiv, 03168. Phone: (044) 226-26-56. Fax: (044) 226-26-56

Email: kabmin_doc@mil.gov.ua

Code in the Uniform Register of Businesses and Organizations of Ukraine: 22991050

_____ No. _____

Administrative Directorate of the General Staff of the
Armed Forces of Ukraine

Foreign Ministry of Ukraine

No. 300/1/C/2056 of April 18, 2015

2:47:27 pm Pages: 1/2



07226876338026924787

In pursuance of Instruction No. 02-01/2948 of October 15, 2014 issued by the Ukrainian Presidential Chief of Staff, presented herewith are informational reference materials pertaining to the body of evidence for the presence of foreign military groups in Ukrainian territory, to be used in raising the awareness of Ukrainian society and international partners more actively and in the future lawsuits to be filed by Ukraine with the relevant international courts.

Attachment: above-mentioned information on 2 pages, unclassified, for the specified recipient only

Acting First Deputy Chief
of the General Staff of the Armed Forces of Ukraine

Major General

[Signature]

V.M. NAZAROV

O.M. Chekurda, 454-40-78

FOREIGN MINISTRY OF UKRAINE
DEPARTMENT OF THE GENERAL SECRETARIAT
Incoming Ref. No. 34517
April 22, 2015

000630*

Order 50-215

INFORMATIONAL REFERENCE MATERIALS

pertaining to the body of evidence for the direct invasion by foreign military groups into Ukrainian territory

I. Regarding the chronology of the crossing of the state border of Ukraine by personnel, weapons, and military vehicles of the Armed Forces of the Russian Federation

No.	Date	Border crossing point crossed	Point of destination (crossing)	Number of convoys	Number of vehicles (personnel)
1	April 16	From the Russian Federation			Humanitarian convoy of 123 vehicles
		“Izvaryne”	Luhansk		61 vehicles
		“Uspenka”	Donetsk		62 vehicles
2	April 15	From the RUSSIAN FEDERATION through CHERVONOPARTYZANSK	SVERDLOVSK		Up to 8 tanks, up to 2 GRAD BM-21 multiple rocket launchers, up to 3 URAL heavy artillery tractors; the arrival of a military unit of the Russian Armed Forces consisting of up to 230 people was also recorded (the fact that they belong to the Russian Armed Forces is confirmed by their uniforms and arm patches as well as insignia of the Russian Armed Forces).
3	April 12	Russian Federation	SUKHODILSK	Train	Ammunition (equivalent of 40 trucks)
4	April 12-13 of this year	Dmytrivka	Marynivka (Donetsk Oblast)		10 tanks.
			Stepanivka (Donetsk Oblast)		40 KamAZ trucks (with munitions and ammo);
5	April 10-11 of this year		From the Russian Federation		Trains carrying military vehicles proceeded in the direction of DONETSK and AMVROSIYIVKA; a mixed convoy (8 tanks, 6 BTR armored personnel carriers, up to 200 personnel) – destination to be updated.
6		STEPANIVKA	Russian Federation		40 trucks (empty)
7	April 10	Chervonopartyzansk	Sverdlovsk		20 tanks (14 T-72, 6 T-64 tanks);
8	April 10	DMYTRIVKA	In the direction of STEPANIVKA	1	15 T-72 tanks, 10 BMD infantry fighting vehicles, and 43 trucks carrying personnel, munitions and ammo
9	April 9	DMYTRIVKA	In the direction of STEPANIVKA	1	20 KamAZ trucks with munitions and ammo

10	April 9	IZVARYNE	LUHANSK	1	5 armored fighting vehicles, 28 trucks with ammo and munitions;
11	April 9	USPENKA	ALCHEVSK	1	122-mm GRAD multiple rocket launcher, 17 trucks towing D-30 cannon mounted on trailers, and a tanker truck

Acting Chief
of the Main Command Center of the Armed Forces of Ukraine

Major General

[Signature]

O.S. SYRSKYI

Annex 121

Expert Opinion No. 193/1, Ukrainian Scientific Research Institute of Special Equipment and Forensic Expert Examination of the Security Service of Ukraine (29 April 2015)

This document has been translated from its original language into English, an official language of the Court, pursuant to Rules of the Court, Article 51.

Pursuant to Rules of the Court Article 51(3), Ukraine has translated only an extract of the original document constituting this Annex. In further compliance with this Rule, Ukraine has provided two certified copies of the full original-language document



SECURITY SERVICE OF UKRAINE
**Ukrainian Scientific Research Institute of Special Equipment
and Forensic Expert Examination**
EXPERT OPINION

04/29/2015

City of Mariupol

No. 193

Counterpart No. 1

I, Oleksiy Petrovych Bordunos, section chief of the Center for Forensic and Special Expert Examinations of the Ukrainian Scientific Research Institute for Special Equipment and Forensic Expert Examination of the Security Service of Ukraine, higher education, special expert training and experience working as an expert since 2002, qualified forensic expert with the right to conduct explosives expert examinations with specializations in “Studying explosive devices and remnants thereof” (Certificate No. 13/6/16/104 issued by the Examination and Qualification Commission of the Security Service of Ukraine on 12/05/2002), pursuant to the Order on the Commissioning of an Explosives Expert Examination dated 03/12/2015, issued in the town of Kramatorsk by Lieutenant S.S. Kovalyov, an investigator with the Investigations Department of the Donetsk Regional Directorate of the Security Service of Ukraine, carried out an expert examination based on the files of the criminal proceeding entered into the Unified Register of Pre-Trial Investigations as No. 2201505000000092 dated 02/10/2015.

I am familiar with the facts of the case from the order on commissioning an expert examination.

Together with Letter No. 56/13-1793nt of 04/1/2015 (incoming ref. No. 1393nt of 04/07/2015), the following items were received for examination:

- copy of the inspection report dated 02/12/2015, 21 pages;
- examination materials in safe packs Nos. 0636365, 2586605, 0636366, 2586606, 2586607, 2586608, 2586609, 2586610, 0636368, 2266428, 0636367, 2266431, 2586567, 2586598, 2586604, 2586595, 2586599, 2266426, 2586579, 0636364, 2266425;
- photographic materials on an optical disk.

The expert was asked to answer the following questions:

1. Based on the inspection and the recovered objects, is it possible to identify the type and sort of munitions, the detonation of which resulted in the explosion, and the type and sort of weapon (artillery system or other type of armament) that was used to fire the munitions, fragments of which and explosive traces of which were found in the course of the inspection. If so, what type and sort of munitions were detonated and from what type of sort of weapon were they fired?

2. Do the objects recovered during the inspection and submitted for expert examination bear any markings that would make it possible to identify the type and sort

of munitions or other identifying marks of the munitions that were detonated?

3. Based on the inspection and the recovered objects, was there a detonation of munitions fired from an artillery system or other type of weapon, or a detonation of stationary, planted munitions or explosive devices (in the latter case, which type and sort of stationary, planted munitions or explosive devices)?

4. Which of the fragments recovered during the inspection are fragments of munitions (explosive devices), and what is the purpose of each component of the munitions (explosive devices), fragments of which were recovered during the inspection?

5. Is it possible, based on the inspection and the objects discovered during the inspection of the incident site, to draw any conclusions as to the direction(s) from which the munitions, the detonation of which was established during the inspection, were fired, as well as the distance from which these munitions were fired?

6. Is it possible, based on the inspection and the objects found during the inspection, to draw any conclusions as to the angle of incidence of the munitions, the detonation of which was established during the inspection. If so, then what was the angle of incidence of the munitions, the detonation of which was established during the inspection, and what firing distance of the munitions is consistent with their established angle of incidence?

The following information sources were used in conducting the expert examination:

- *“Methods of Complex Examination of Explosive Devices, Substances and Traces” (H.V. Prokhorov-Lukin, V.I. Pashchenko, V.I. Bykov, et al – Kyiv: Elite Print LLC, 2011 – 216 p.: ill.);*
- *“Mass Produced Explosive Devices and Their Forensic Examination” (Yu.M. Dildin, V.V. Martynov, Expert Consulting Center of the Ministry of Internal Affairs of the Russian Federation. Moscow. 1991);*
- *“Technical Description of the 9M55K Rocket-Propelled Shell”;*
- *“Operating Instructions for the 9M55K Rocket-Propelled Shell”;*
- *“Markings of Artillery Ammunition” (P.N. Deryabin, M.N. Krasnov, Penza 1999);*
- *“Principles of Artillery Firing and Rocket Launches” (National University of the Ministry of Defence of Ukraine, 2011).*

The expert has been warned of the potential liability for presenting knowingly inaccurate findings and for refusing without a valid reason to perform their duties under Articles 384 and 385 of the Criminal Code of Ukraine.

[signature] O. Bordunos

EXAMINATION

The items submitted for examination were packed in accordance with the rules for the storage and transportation of physical evidence.

The examination was conducted visually under laboratory conditions in daylight at an air temperature of +20 °C.

The following instruments and devices were used:

- caliper No. 51207638
- metal ruler GOST 427-56;
- forensic tape measure SV-1
- magnifying glass with 4x magnification;
- OLYMPUS x-775 camera.
- KERN 440-33 electronic scales No. WC0627326 – certificate No. 35-02/149678 dated 11/24/2014.

Upon being opened, the safe packs were found to contain the following:

1. No. 2266428 (illustration no. 2)
 - six objects made of non-magnetic metal, irregular in shape, grey in color, similar in appearance to fragments from the base body of a 9B171 control system unit from a 9m55k rocket-propelled shell for a Smerch multiple rocket launcher; one object bears the markings 1615 91 (object No. 1);
 - a rectangular object of magnetic metal, black in color, with maximum dimensions of 45x33; the object is similar in appearance to the wing of a 9N235 warhead fragmentation element (object No. 2);
 - an object of magnetic metal, grey in color, in the form of a nut measuring 80 mm in diameter; the object bears three key grooves;
 - an object of irregular shape made of grey magnetic metal with maximum dimensions of 112x52 mm.
2. No. 0636367 (illustration No. 4):
 - set of shielded wires with a maximum length of 200 mm;
 - fragment of electronic circuit board measuring 20x40 mm;
 - metal washer with attached connector, with a diameter of 52 mm.
3. No. 2266426 (illustration No. 5):
 - thirty objects made of non-magnetic metal, irregular in shape, grey in color, some of which have threads, similar in appearance to fragments of the base body of a 9B171 control system unit from a 9m55k rocket-propelled shell for a Smerch multiple rocket launcher (object No. 1);
4. No. 2586610 (illustration No. 6):
 - two cylindrical objects of magnetic metal, grey in color, with a diameter of 7 mm, a height of 16 mm and a weight of 4.2 g (object No. 3);
 - fragment of a magnetic metal ring with a diameter of 27 mm (object No. 5);
 - ten objects of irregular shape made of non-magnetic metal, grey in color (object No. 6);
5. No. 2266425 (illustration No. 8):

- eleven objects of irregular shape made of magnetic metal, grey in color (object No. 6);
 - three objects made of molding material, brown in color.
6. No. 2586595 (illustration No. 10):
- four objects of irregular shape, black in color, 19 mm thick, with maximum dimensions of 90x46 mm, similar in appearance to graphite liners;
 - two objects, black in color, made from molding material with maximum dimensions of 80x34 mm.
7. No. 0636364 (illustration No. 11):
- twenty-three objects made of non-magnetic metal, of irregular shape, grey in color (object No. 6);
 - rectangular object made of magnetic metal, black in color, with maximum dimensions of 61x33, similar in appearance to the wing of a 9N235 warhead fragmentation element (object No. 2);
 - four cylindrical objects of magnetic metal, grey in color, with a diameter of 7 mm, a height of 16 mm and a weight of 4.2 g (object No. 3).
8. No. 2586608 (illustration No. 12):
- six objects made of non-magnetic metal, of irregular shape, grey in color (object No. 6);
 - a rectangular object of magnetic metal, black in color, with maximum dimensions of 35x32; the object is similar in appearance to the wing of a 9N235 warhead fragmentation element (object No. 2);
 - a cylindrical object of magnetic metal, grey in color, with a diameter of 7 mm, a height of 16 mm and a weight of 4.2 g (object No. 3).
9. No. 2586579 (illustration No. 13):
- twenty-six objects of irregular shape made of non-magnetic metal, grey in color (object No. 6);
10. No. 0636365 (illustration No. 14):
- twenty-nine objects of irregular shape made of non-magnetic metal, grey in color (object No. 6);
 - a rectangular object of magnetic metal, black in color, with maximum dimensions of 45x32; the object is similar in appearance to the wing of a 9N235 warhead fragmentation element (object No. 2);
 - three cylindrical objects of magnetic metal, grey in color, with a diameter of 7 mm, a height of 16 mm and a weight of 4.2 g (object No. 3).
11. No. 2586609 (illustration No. 15):
- five objects of irregular shape made of non-magnetic metal, grey in color (object No. 6);
12. No. 2586604 (illustration No. 16):
- seven cylindrical objects of magnetic metal, grey in color, with a diameter of 7 mm, a height of 16 mm and a weight of 4.2 g (object No. 3);
 - cylindrical object of magnetic metal, grey in color, with a diameter of 5 mm, a height of 5 mm and a weight of 0.8 g (object No. 4);
 - object of irregular shape made of non-magnetic metal, grey in color, with maximum dimensions of 15x9 mm (object No. 6);

13. No. 2586606 (illustration No. 17):

- a cylindrical object of magnetic metal, grey in color, with a diameter of 7 mm, a height of 16 mm and a weight of 4.2 g (object No. 3);
- cylindrical object of magnetic metal, grey in color, with a diameter of 8 mm, a height of 3 mm and a weight of 0.8 g (object No. 4);
- two rectangular objects of magnetic metal, black in color, with maximum dimensions of 59x32; the objects are similar in appearance to the wing of a 9N235 warhead fragmentation element (object No. 2);

14. No. 2586567 (illustration No. 18):

- seven objects of irregular shape made of non-magnetic metal, grey in color (object No. 6);
- two rectangular objects of magnetic metal, black in color, with maximum dimensions of 55x33; the objects are similar in appearance to the wing of a 9N235 warhead fragmentation element (object No. 2);

15. No. 2586605 (illustration No. 19):

- seven objects of irregular shape made of non-magnetic metal, grey in color (object No. 6);

16. No. 0636368 (illustration No. 20):

- ten objects of irregular shape made of non-magnetic metal, grey in color (object No. 6);
- a rectangular object of magnetic metal, black in color, with maximum dimensions of 64x33; the objects are [sic] similar in appearance to the wing of a 9N235 warhead fragmentation element (object No. 2);

17. No. 2586599 (illustration No. 21):

- twenty-two objects of irregular shape made of non-magnetic metal, grey in color; some of the objects have fragments of threads (object No. 6).

18. No. 2586607 (illustration No. 22):

- a cylindrical object of magnetic metal, grey in color, with a diameter of 7 mm, a height of 16 mm and a weight of 4.2 g (object No. 3);
- six objects of irregular shape made of non-magnetic metal, grey in color (object No. 6);
- a rectangular object of magnetic metal, black in color, with maximum dimensions of 53x33; the object is similar in appearance to the wing of a 9N235 warhead fragmentation element (object No. 2).

19. No. 2266431 (illustration No. 23):

- three cylindrical objects of magnetic metal, grey in color, with a diameter of 7 mm, a height of 16 mm and a weight of 4.2 g (object No. 3);
- thirty objects of irregular shape made of non-magnetic metal, grey in color (object No. 6);
- two rings made of magnetic metal with a diameter of 27 mm (object No. 5);
- two rectangular objects of magnetic metal, black in color, with maximum dimensions of 55x32; the objects are similar in appearance to the wing of a 9N235 warhead fragmentation element (object No. 2).

All of the objects submitted for examination show signs of deformation.

In order to reconstruct the explosive devices, the physical evidence was sorted into groups by general and individual features:

1. Fragments of the body of a fuse (object No. 5).
2. Remnants of the body of a subwarhead (object No. 6)
3. Pre-formed fragments (objects Nos. 3, 4)
4. Wing of a warhead element (object No. 2).

Objects Nos. 2–6 show traces of the shattering effect of an explosion (serrations, indentations, scratches, soot). No markings were found on the images of the objects.

In order to answer the questions that were posed, the objects submitted for examination were compared with the corresponding parameters indicated in the standard technical documentation. The results of this examination are shown in the tables.

Comparative Table No. 1

Features of basic components	Subject of comparison	Examined object
	Pre-formed fragment (rollers) of a 9N235 warhead fragmentation element	Objects Nos. 3 and 4
Material of construction	grey metal	grey metal
Height, mm	15 (5)	~16 (5)
Diameter, mm	7 (5)	~7
Weight, g	4.2 (0.8)	4.2 (0.8)

Comparative Table No. 2

	Wing of a 9N235 warhead fragmentation element	Objects No. 2
Material of construction	black metal	black metal
Height, mm	32	32-33
Wing shape	convex	convex
Thickness, mm	1	1

The examination objects were also visually compared with the image of a 9N235 warhead fragmentation element. The matching features are indicated in illustrations Nos. 9-11.

The comparative examinations showed that the following are fragments of 9N235 warhead fragmentation elements of 9M55K multiple rocket launchers for Smerch multiple rocket launchers:

- fuse body fragments (object No. 5) – fuse 9E272 is designed to produce a detonation impulse upon reaching the target or at the end of self-destruction period;

115 [handwritten]

- fragments of a warhead element body (object No. 6) – designed for the placement of 360 pre-formed fragments (rollers); explosive charge (312 g) and fuse;
 - pre-formed fragments (objects No. 3 and 4) – designed to inflict losses on enemy personnel and unarmored equipment;
 - fragments of warhead wings (object No. 2) – designed to ensure guided flights to the target;

The 9N235 warhead has the following characteristics:

- weight 1,810 g;
- explosive charge 312 r;
- pre-formed fragments (rollers) – 300 units measuring 0.8 g and 60 items weighing 4.2 g.

In order to conduct further research, the expert, in the presence of the investigator, inspected the physical evidence stored at the Kramatorsk office of the Donetsk Regional Directorate of the Security Service of Ukraine (illustrations Nos. 25, 27 and 28) and inspected the landing sites of the munitions in the town of Kramatorsk.

Upon inspection, the rocket parts were found to have the following markings (illustrations Nos. 32 and 33):

1. 9x87.000
29-91-M

- 29 is propulsion unit's manufacturing lot number;
- 91 is the year of manufacture of the charge;
- M is the code of the factory that manufactured the charge.

2. 9D 167
9Kh317M
-91-IV
02
RG OV

The markings were made with black dye. These markings match the markings of rocket-propelled shells.

In addition, the rocket parts have annular bands that show the shell's binding grip area. The shell's binding grip area is marked with the word "Bandazh" ("Binding") in white dye.

The manufacturer places markings on the rocket parts that indicate the lot number, year of manufacture, and manufacturer's code.

Because the expert did not have access to the technical specifications for these shells, it is not possible to identify the markings indicated in section 2.

The rocket parts (9D167) are designed to deliver the 9N139 cluster fragmentation warhead to its target.

The expert then examined the object similar in appearance to a nozzle cluster, which includes a cone, graphite lining, bell, and aerodynamic stabilizer, which consists of a base in whose tapered notches six blades are installed on pins (illustration No. 27). The nozzle cluster of a 9M55K rocket-propelled shell is designed to maintain the rotating path of the shell on the flight trajectory.

An inspection of the frames (illustration No. 28) revealed that they are welded and consist of a docking ring, rod, disk, and four plates with holes, and are frames from the cluster warhead sections of a 9M55K rocket-propelled shell and are designed for the placement and dispersion of eight guides for warhead elements.

An inspection of the guide revealed that it is made of metal (probably aluminum) in the form of a thin-walled tube with 20-mm holes (illustration No. 25) and is a guide for a cluster warhead section of a 9M55K rocket-propelled shell, designed for the placement of nine 9N235 pre-formed fragmentation elements and to ensure that they are ejected within 4 s after leaving the frame.

Based on a study of the submitted materials and an inspection of the landing sites of the munitions parts, the expert compiled a drawing (illustration No. 30) and, with the help of the <https://maps.yandex.ua> website, calculated the distance from where the remnants of the rocket sections of shells landed to the sites of the explosions of the fragmentation warhead elements, and established the approximate direction from which the shells were fired by a Smerch multiple rocket launcher: the northeastern outskirts of the town of Horlivka, Donetsk Region.

Considering that a 9M55K rocket-propelled shell has a maximum flight distance of 70 km and a minimum of 20 km (according to the information contained in the technical documentation for the 9M55K rocket-propelled shell), it is possible to estimate the firing distance at 20–70 km from the epicenters of the explosions (illustration No. 31).

Based on the inspection and the recovered objects, the explosions occurred as a result of the detonation of 9N235 warhead fragmentation elements, which were delivered to their target by 9M55K rocket-propelled shells (at least 16 of them), which were fired from two or more Smerch multiple rocket launchers.

Based on the results of the inspection and the objects recovered during the inspection, it is not possible to draw any conclusions as to the angle of incidence of the munitions, the detonation of which was recorded during the inspection.

The operating principle of the 9M55K rocket-propelled shell consists in the following: the 9D167 rocket section is activated by an electric signal from the warhead apparatus. Under the pressure of gas, which is formed by the burning of the rocket section charge, the stopper is destroyed and gasses leak out of the nozzle. Once the jet thrust is achieved, the guide stopper is activated and the rocket-propelled shell begins to move along the guide. When the two carrier pins of the rocket section interact with the spiral grooves of the combat vehicle guide, the shell begins to spin. Once the shell leaves the combat vehicle guide, six wings are deployed.

After the shell leaves the tube, the acceleration in the control system unit and the flight countdown in the electronic timing device start to become integrated. During flight, the control system unit measures the longitudinal acceleration and makes adjustments. The control system unit measures the angular deviations and, if necessary, activates the thruster. At a pre-set point of the rocket-propelled shell's flight trajectory, upon a command from the electronic timing device, the frame with the guides is separated from the shell. The centrifugal force and incoming air flow fling the guides from the frame. After a pre-set interval, the warhead elements are thrust from the guides, their wings open up, and they fly toward their target. When the warhead comes into contact with an obstacle, it detonates or, if no detonation occurs upon impact, it self-destructs after a certain interval.

CONCLUSIONS

1. Based on the inspection and the recovered objects, the explosions occurred as a result of the detonation of 9N235 warhead fragmentation elements, which were delivered to their target by 9M55K rocket-propelled shells (designed to inflict losses on enemy personnel and unarmored equipment), which were fired from two or more Smerch multiple rocket launchers.

2. Two of the objects bear markings that are typical for the markings (color, layout, print height) placed on the bodies of rocket sections of 9M55K rocket-propelled shells.

3. Based on the inspection and recovered objects, there was an explosion of munitions fired from a Smerch multiple-rocket artillery system.

4. The fragments of munitions (explosive devices) include:

- 9N235 warhead fragmentation element:
 - fragments of the fuse body (object No. 5) – fuse 9E272, designed to release a detonation signal upon reaching the target or at the end of the self-destruct period;
 - warhead body fragments (object No. 6) – the body is designed to hold 360 pre-formed fragmentation elements (rollers) and an explosive charge 312 g;
 - pre-formed fragmentation elements (objects Nos. 3 and 4), designed to inflict losses on enemy personnel and unarmored equipment;
 - fragments of warhead element wings (object No. 2) – wings are designed to ensure targeted flight to the target;
- rocket sections (9D167), designed to deliver 9N139 cluster fragmentation warheads to the target;
- fragments of a control system unit (9B171) – a control system unit designed to measure angular deviations of the shell from its pre-set course; working out the thrust forces in the process of angular stabilization according to the information regarding its angular deviations; measuring the acceleration along the longitudinal axis of the shell;

and computing and entering into the 9B172 electronic timer any adjustments to the time of opening of the cluster warhead section;

- fragments of the electronic timer (9B172) – the electronic timer is designed to give a command to activate the safety and arming system for the opening of the cluster warhead section according to its pre-set trajectory;
- fragments of the nozzle cluster of a 9M55K rocket-propelled shell – the nozzle cluster is designed to ensure the rotating movement of the shell on its flight trajectory and the ensure the release of gases from the nozzle unit;
- frame of the nozzle cluster of a 9M55K rocket-propelled shell –the cluster is designed for the placement and dispersion of either guides from the warhead elements;
- guide for a cluster warhead of a 9M55K rocket-propelled shell – the guide is designed for the placement of nine 9N235 warhead fragmentation elements and their ejection 4 s after leaving the frame.

5. Based the inspection and the objects recovered during the inspection, it is possible to draw the conclusion that the likely direction from which the munitions were fired is the northeastern outskirts of Horlivka, Donetsk Region. The distance from which the munitions whose detonation was recorded during the inspection were fired is 20–70 km from the epicenter of the explosions.

6. Based on the inspection and the objects found during the inspection, it is not possible to draw any conclusions as to the angle of incidence of the munitions whose detonation was recorded during the inspection.

Attached: Table of illustrations, 7 pages

Expert: [signature] O. Bordunos

[stamp:] Donetsk Regional Directorate of the Security Service of Ukraine, No. 56/21-1160nt,
29.04.2015

**SECURITY SERVICE OF UKRAINE
TABLE OF ILLUSTRATIONS
TO EXPERT OPINION No. 193 of 04.29.2015**

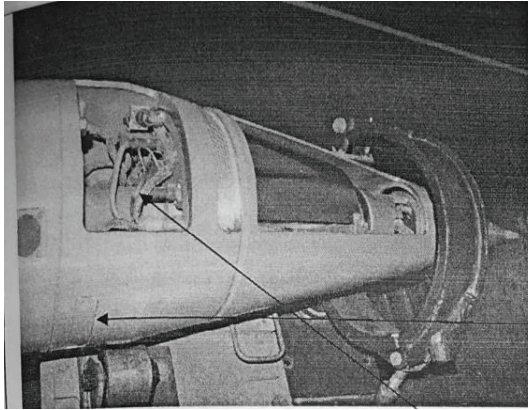

Illustration No. 1. View of 9B171 control system unit of a sectional model of the 9M55K rocket-propelled shell for a Smerch multiple-rocket launcher

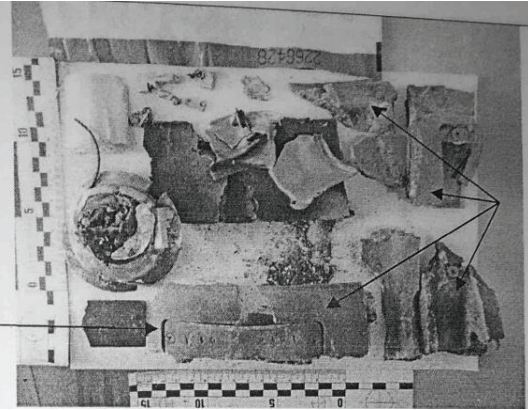

Illustration No. 2. Contents of safe pack No. 2266428 (remnants of base body of 9B171 control system unit)

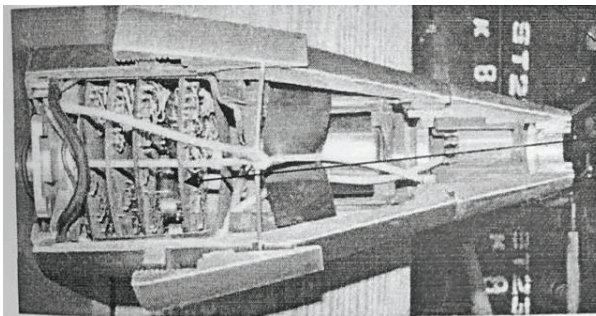

Illustration No. 3. View of sectional model of 9B172 electronic timer for a 9M55K rocket-propelled shell

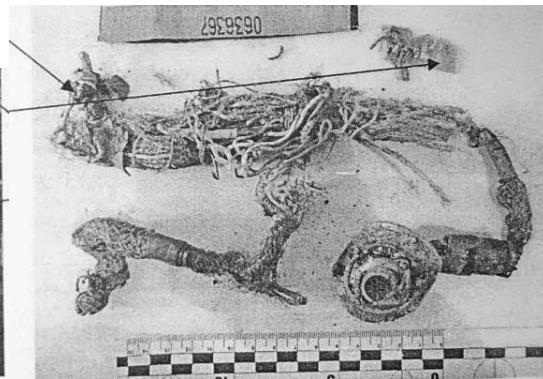

Illustration No. 4. Contents of safe pack No. 0636367 (remnants of shielded wires from a 9B171 control system unit and a plate from the 9B172 electronic timer)



Illustration No. 5. Contents of safe pack No. 2266426 (remnants of the base body of a 9B171 control system unit and 9B172 electronic timer)



Illustration No. 6. Contents of safe pack No. 2586610 (remnants of warhead fragmentation element 9N235)

Experts

[signature]

O. Bordunos

**SECURITY SERVICE OF UKRAINE
TABLE OF ILLUSTRATIONS
TO EXPERT OPINION No. 193 of 04.29.2015**

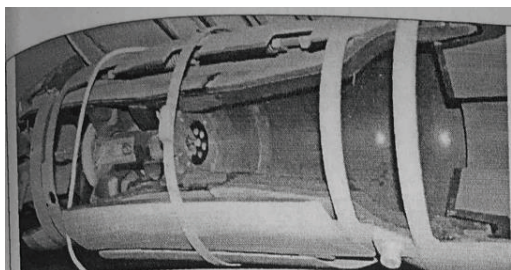

Illustration No. 7. View of the nozzle cluster of a sectional model of a 9M55K rocket-propelled shell for a Smerch multiple-rocket launcher



Illustration No. 8. Contents of safe pack No. 2266425

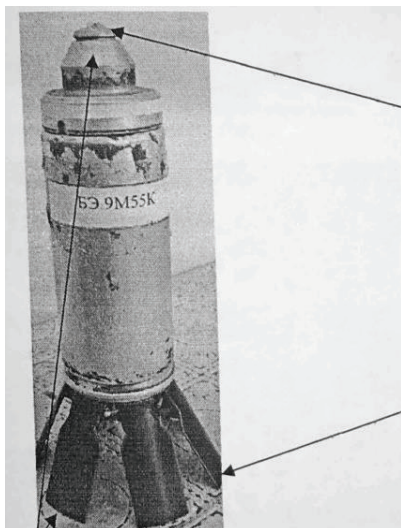

Illustration No 9. View of 9N235 warhead fragmentation element



Illustration No. 10. Contents of safe pack No. 2266431 (fragments of 9N235 warhead fragmentation element)

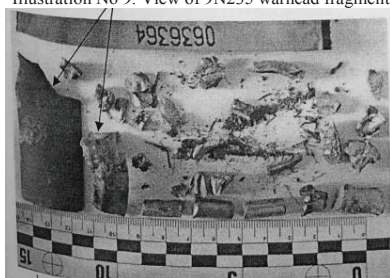

Illustration No. 11. Contents of safe pack No. 0636364 (fragments of 9N235 warhead fragmentation element)



Illustration No. 12. Contents of safe pack No. 2586608 (fragments of 9N235 warhead fragmentation element)

Experts

[signature]

O. Bordunos

**SECURITY SERVICE OF UKRAINE
TABLE OF ILLUSTRATIONS
TO EXPERT OPINION No. 193 of 04.29.2015**



Illustration No. 19. Contents of safe pack No. 2586605 (fragments of 9N235 warhead fragmentation element)



Illustration No. 20. Contents of safe pack No. 0636368 (fragments of 9N235 warhead fragmentation element)



Illustration No. 21. Contents of safe pack No. 2586599 (remnants of body of 9B171 control system unit and electronic timer 9B172)



Illustration No. 22. Contents of safe pack No. 2586607 (fragments of 9N235 warhead fragmentation element)



Illustration No. 23. Contents of safe pack No. 2586595 (fragments of graphite liner of nozzle cluster)

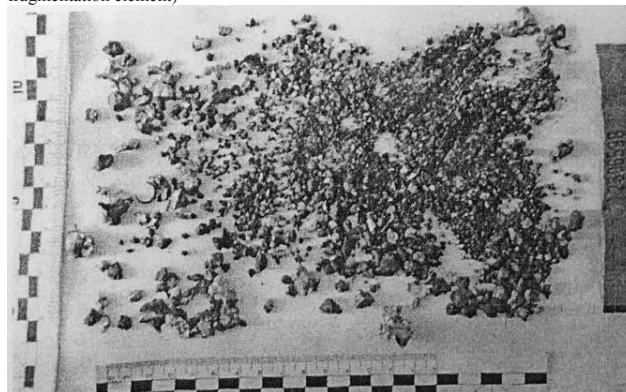

Illustration No. 24. Contents of safe pack No. 2586598

Experts

[signature]

O. Bordunos

**SECURITY SERVICE OF UKRAINE
TABLE OF ILLUSTRATIONS
TO EXPERT OPINION No. 193 of 04.29.2015**



Illustration No. 13. Contents of safe pack No. 2586579 (fragments of 9N235 warhead fragmentation element)

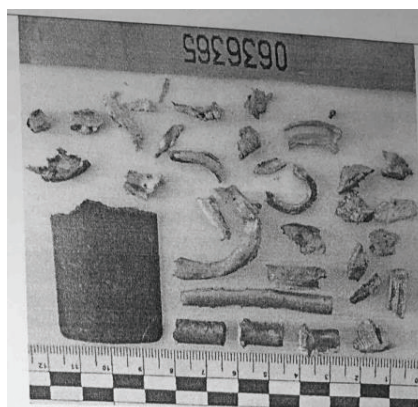

Illustration No. 14. Contents of safe pack No. 0636365 (fragments of 9N235 warhead fragmentation element)



Illustration No. 15. Contents of safe pack No. 2586609 (fragments of 9N235 warhead fragmentation element)



Illustration No. 16. Contents of safe pack No. 2586604 (fragments of 9N235 warhead fragmentation element)

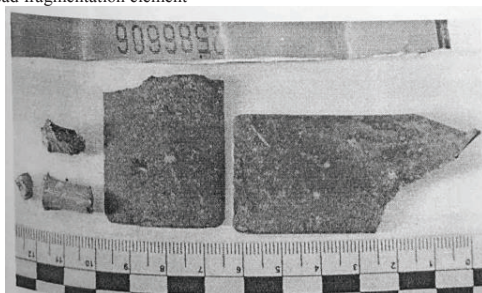

Illustration No. 17. Contents of safe pack No. 2586606 (fragments of 9N235 warhead fragmentation element)



Illustration No. 18. Contents of safe pack No. 2586567 (fragments of 9N235 warhead fragmentation element)

Experts

[signature]

O. Bordunos

**SECURITY SERVICE OF UKRAINE
TABLE OF ILLUSTRATIONS
TO EXPERT OPINION No. 193 of 04.29.2015**

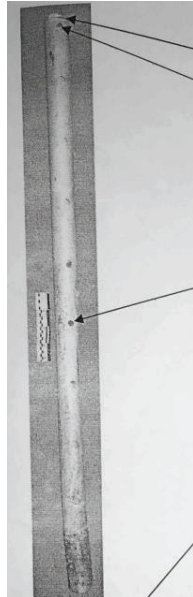

Illustration No. 25. Guide for cluster warhead of 9M55K rocket-propelled shell for a Smerch multiple-rocket launcher

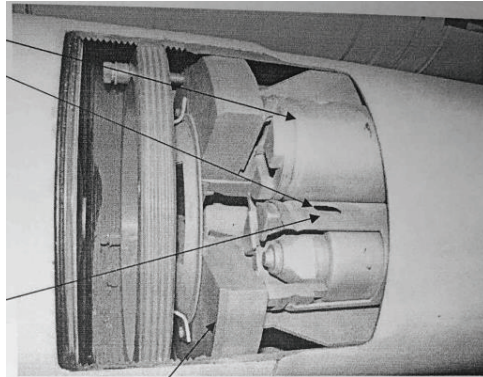

Illustration No. 26. View of guide in frame of sectional model of 9M55K rocket-propelled shell for a Smerch multiple-rocket launcher

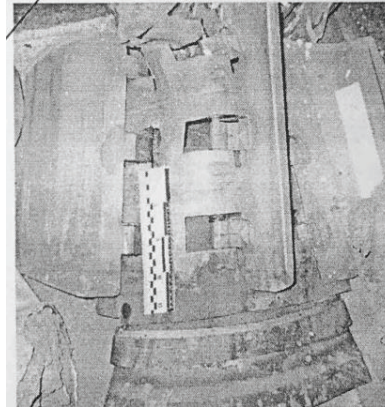

Illustration No. 27. Aerodynamic stabilizer



Illustration No. 18. Frames for cluster warhead of 9M55K rocket-propelled shell for a Smerch multiple-rocket launcher

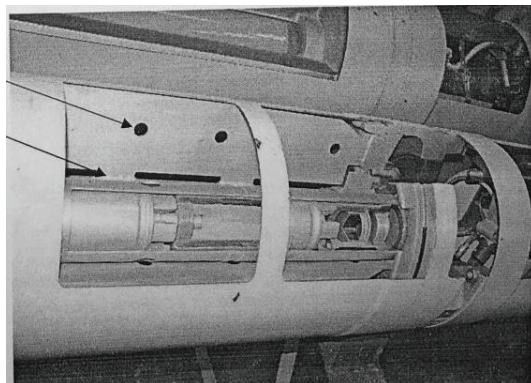

Illustration No. 29. View or frame of 9M55K rocket-propelled shell for a Smerch multiple-rocket launcher

Experts

[signature]

O. Bordunos

**SECURITY SERVICE OF UKRAINE
TABLE OF ILLUSTRATIONS
TO EXPERT OPINION No. 193 of 04.29.2015**



Illustration No. 30. Drawing of landing sites of rocket remnants and explosions of 9N235 warhead fragmentation element [yellow] – landing site of rocket section; [pink] site of explosions of fragmentation warhead elements; → - probable flight direction of shell]

Experts

[signature] O. Bordunos

**SECURITY SERVICE OF UKRAINE
TABLE OF ILLUSTRATIONS
TO EXPERT OPINION No. 193 of 04.29.2015**

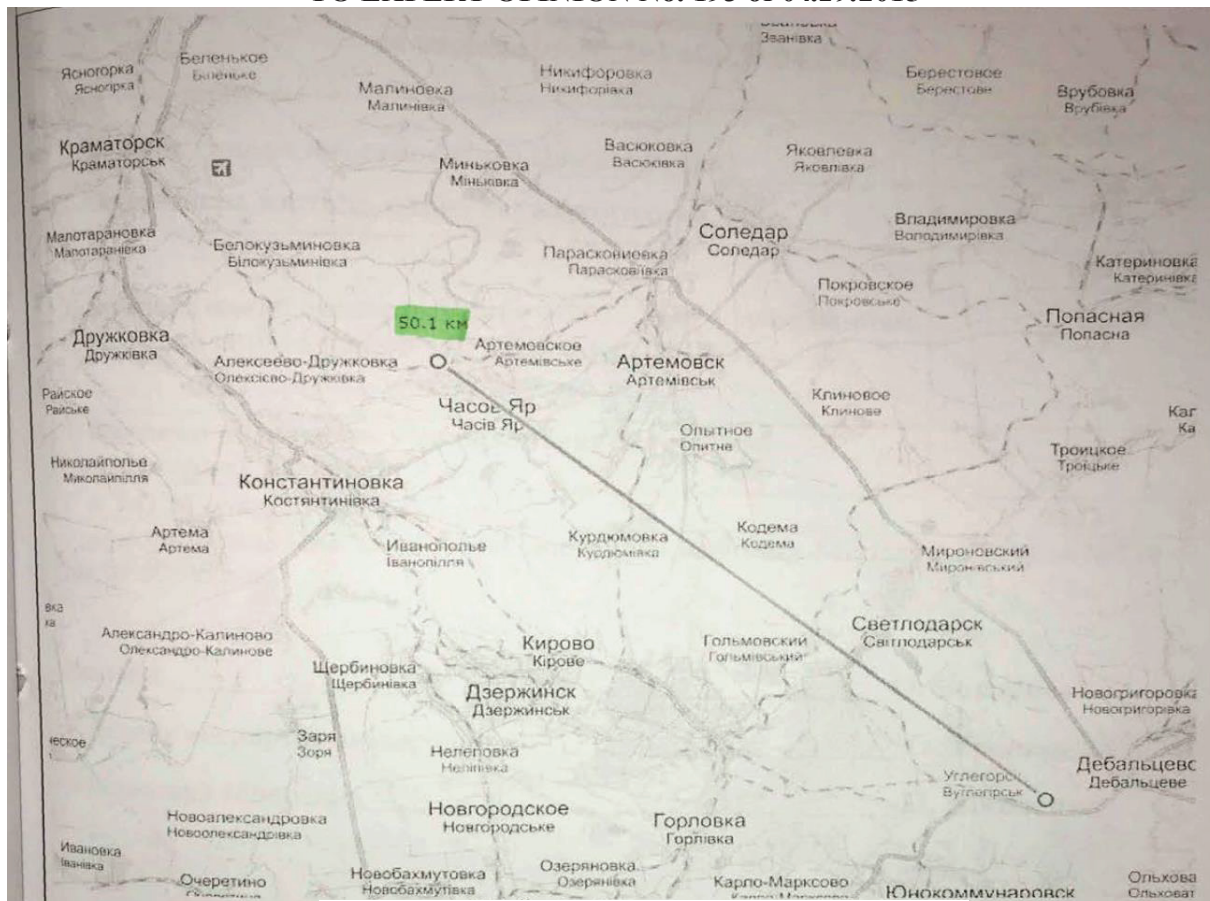

Illustration No. 31. Probable direction of firing

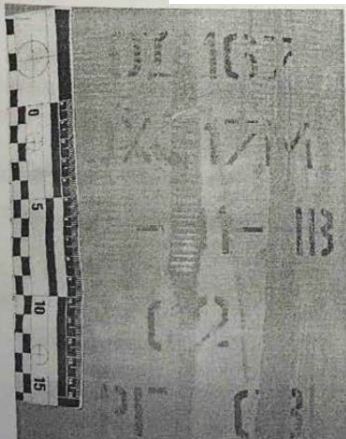

Illustration No. 32. Markings of 9M55K rocket-propelled shell

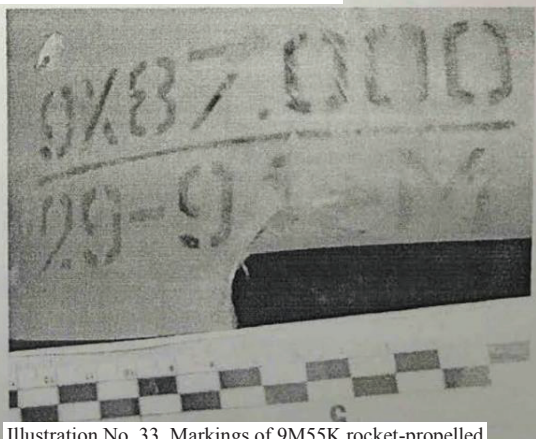

Illustration No. 33. Markings of 9M55K rocket-propelled shell for a Smerch multiple-rocket launcher

Experts

[signature]

O. Bordunos

Annex 122

Administrative Directorate of the General Staff of the Armed Forces of Ukraine
Letter No. 300/1/C/2329 (2 May 2015)

This document has been translated from its original language into English, an official language of the Court, pursuant to Rules of the Court, Article 51.

Pursuant to Rules of the Court Article 51(3), Ukraine has translated only an extract of the original document constituting this Annex. In further compliance with this Rule, Ukraine has provided two certified copies of the full original-language document



MINISTRY OF DEFENSE OF UKRAINE

GENERAL STAFF OF THE ARMED FORCES OF UKRAINE

6 Povitroflotsky Prospect, Kyiv, 03168. Phone: (044) 226-26-56. Fax: (044) 226-26-56

Email: kabmin_doc@mil.gov.ua

Code in the Uniform Register of Businesses and Organizations of Ukraine: 22991050

_____ No. _____

Administrative Directorate of the General Staff of the Armed Forces of Ukraine Foreign Ministry of Ukraine

No. 300/1/C/2329 of May 2, 2015

16:52:03 Page: 1/2



In pursuance of Instruction No. 02-01/2948 of October 15, 2014 issued by the Ukrainian Presidential Chief of Staff, presented herewith are informational reference materials pertaining to the body of evidence for the presence of foreign military groups in Ukrainian territory, to be used in raising the awareness of Ukrainian society and international partners more actively and in the future lawsuits to be filed by Ukraine with the relevant international courts.

Attachment: above-mentioned information on 6 pages, unclassified, for the specified recipient only.

Acting First

Deputy Chief of the General Staff

of the Armed Forces of Ukraine

Lieutenant General

[Signature]

I.I. KOLESNYK

[Typed by] D.S. Pasko, 454-40-78

FOREIGN MINISTRY OF UKRAINE
DEPARTMENT OF THE GENERAL SECRETARIAT
Incoming Ref. No. 39627
May 8, 2015

000674*

Order 50-2015

[...]

II. Regarding the chronology of the crossing of the state border of Ukraine by personnel, weapons, and military vehicles of the Armed Forces of the Russian Federation

No.	Date	Border crossing point crossed	Point of destination (crossing)	Number of convoys	Number of vehicles (personnel)
1.	30.04	IZVARINE	LUHANSK		10 tarpaulin trucks and 4 GRAD BM-21 multiple rocket launchers, 3 trailer trucks, 4 tarpaulin vans, and 4 unidentified vehicles (type to be updated), up to 15 BMP-1 (or BMD-1) armored personnel carriers, and 1 tank (type to be updated)
2.	28.04	IZVARINE			17 units of BMP armored personnel carriers;
3.		IZVARINE	LUHANSK		10 units of MTLB light-armored multipurpose tracked towing vehicles
4.	27.04	Izvaryne	LUHANSK	1	17 tanks
5.	24.04	From the territory of Ukraine	Russian Federation		Up to 24 trucks (presumably empty) and one multiple rocket launcher
6.	24.04	Though USPENKA border crossing point	In the direction of KHARTSYZK	2	Up to 25 tanks and 7 trucks with personnel and canon in tow
7.	23.04	Izvaryne	KRASNODON-LUHANSK	1	Trucks with munitions and ammo – 11 units
8.	23.04	Izvaryne	LUHANSK	2	Humanitarian convoy of 60 vehicles
		Uspenka	DONETSK		Humanitarian convoy of 62 vehicles
9.	22.04	From the Russian Federation	SUKHODOLSK	Train	Freight cars with ammo

Chief of the Main Command Center
of the Armed Forces of Ukraine

Lieutenant General

[Signature]

S.M. POPKO

Annex 123

Expert Opinion No. 16/8, drafted by Ukrainian Scientific Research Institute for Special Equipment and Forensic Expert Examinations, Security Service of Ukraine (7 May 2015)

This document has been translated from its original language into English, an official language of the Court, pursuant to Rules of the Court, Article 51.

Pursuant to Rules of the Court Article 51(3), Ukraine has translated only an extract of the original document constituting this Annex. In further compliance with this Rule, Ukraine has provided two certified copies of the full original-language document



SECURITY SERVICE OF UKRAINE
Ukrainian Scientific Research Institute for Special Equipment
and Forensic Expert Examinations
EXPERT OPINION

05/07/2015 City of Kyiv No. 16/8

I, Candidate of Technical Sciences Oleksandr Yuriyovych Koshel, an expert with the 4th Center (Center for Forensic and Special Expert Examinations) of the Ukrainian Scientific Research Institute for Special Equipment and Forensic Expert Examinations of the Security Service of Ukraine, possessing an advanced degree, special criminalistics training and the qualification of a forensic expert with a specialization in “Metals and Alloys Research” (certificate No. 512 issued by the Expert Qualification Commission of the Security Service of Ukraine on 04/23/2014, valid until 04/23/2019), having worked as an expert since 2014, pursuant to an order calling for an expert examination of metals and alloys dated January 15, 2015, issued by Colonel of Justice Ye.L. Kosyak, Deputy Head of the Investigations Department of the Donetsk Regional Directorate of the Security Service of Ukraine, in criminal proceeding No. 2201505000000021, conducted an expert examination of materials, substances and items.

The physical evidence was delivered to the institute by special courier in separate packaging. The expert examination was tasked with answering the following questions:

1. *From what metal (alloy) are the objects listed in the narrative part of the order made?*
2. *Do the objects listed in the narrative part of the order belong to the same class (group) based on the material from which they are made?*
3. *From what grade of metal (alloy) are the objects listed in the narrative part of the order and submitted for expert examination made?*
4. *Is the metal (alloy) from which the objects listed in the narrative part of the order and submitted for expert examination are made used for the manufacture of munitions for artillery systems, particularly for multiple rocket launchers?*

The expert has been warned of potential liability for presenting knowingly false findings under Article 384 of the Criminal Code of Ukraine: [stamp]:

Security Service of Ukraine [signature] /O.Yu. Koshel/
For Expert Examinations #1]

The research necessary for answering questions 3 and 4 requires information as to the grades and alloys that are used to manufacture the armaments. Therefore, the investigator sent Request No. 5/17 of 02/10/2015 for the provision of information from the standard documents (standards, technical specifications, etc.) with details of the grades and alloys used to manufacture the relevant types of armaments.

Together with cover letter No. 56/13-406nt of 01/20/2015, the Donetsk Regional Directorate of the Security Service of Ukraine provided for expert examination (in accordance with the cover letter) 2

sacks, 5 envelopes, 2 plastic bags, 4 glass bottles, and 2 zip-lock plastic bags.

I. RESEARCH

1.1. Survey and description of the physical evidence

The submitted physical evidence was packed in sacks, envelopes, plastic bags and glass bottles with rubber cork, which contained deformed metal objects with signs of contact interaction with other objects.

Pieces of physical evidence collected from the epicenters of the explosions were marked with Latin letters. Other pieces of physical evidence were marked with numbers.

A white sack (section 1, Table of Illustrations 1, ill. 1), the upper part of which was tied and bound with a thread, the ends of which were glued between two parts of a piece of paper (label) folded in half, without any signs of opening. The label bore the explanatory note “Pack No. 1. Research materials 2201505000000021; - 5 metal objects. Packed by:” with a note on the reverse side: “O. Kocherhin, for the criminal proceedings” and a signature. Contents:

- piece of paper (label) folded in half and glued, with the explanatory text “Pack No. 3. Witnesses. 1. 2. Senior Lieutenant of Justice V. Starostenko, Senior Investigator with the Investigations Department of the Donetsk Regional Directorate of the Security Service of Ukraine” and three signatures, with a note on the reverse side: “explanatory note, cylindrical metal object found during the examination on 01/14/2015” (section 1 of the table of illustrations, ill. 1)
- metal fragment measuring around 85 cm in length and up to 8 cm in width (section 1, ill. 2, **A**);
- metal fragment measuring around 10 cm in length and around 5 cm in width (section 1, ill. 3, **B**);
- metal object measuring around 25 cm in length and 20 cm in width with the marking “559-76-6 KZh 10” and, below that, “1237” (section 1, ill. 4, **C**). Upon the removal of soil, a metal fragment was found in the internal cavity, measuring around 22 cm in length and around 5 cm in width (section 1, ill. 4, **D**);
- a metal fragment measuring around 40 cm in length and up to 15 cm in width (section 1, ill. 5, **E**).
- a metal fragment measuring around 72 cm in length and around 13 cm in diameter (section 1, ill. 6, **F**).

A white sack (No. 2, ill. 7 and 8), the upper part of which was tied and bound with a thread, the ends of which were glued between two parts of a piece of paper (label) folded in half. The label bore the explanatory note “Pack No. 1. Research materials 2201505000000021; - 4 metal objects. Packed by:” with a note on the reverse side: “O. Kocherhin, for the criminal proceedings” and a signature, without any signs of opening. The fabric of the lower part of the sack was damaged (section 1, ill. 7).

- a plastic bag with a piece of paper with the note “No. 190 01/13/15” and one metal object (section 2, ill. 6, **No. 24**);

- a plastic bag with a piece of paper with the note “No. 197 01/14/15” and one metal object (section 2, ill. 6, **No. 23**).

A white makeshift paper bag with the note “corpse of O.M. Shudykin No. 198 of 01/14/15, 3 pieces of grey met. Forensic Medical Expert M.A. Laktyonov”, bound along the upper edge by three metal staples, with no signs of opening. The bag contained three metal objects (section 2, ill. 7, **No. 25, 25, 27**).

A white makeshift paper bag with the note “Fragments from corpse No. 191 dated 01/14/2015. Forensic Medical Expert S.A. Komyshan”, bound along the perimeter by metal staples, without signs of opening (section 2, ill. 8). The bag contained four hermetically sealed glass bottles (section 2, ill. 8) with notes on a paper glued to the bottle and the following contents (section 2, ill. 9):

- a bottle labeled “Toxicology – lung from the corpse of L.I. Starchak 1944, certificate No. 191 of 01/14/15, Forensic Medical Expert S.A. Komyshan.” The bottle contained a metal object (**No. 28**);

- a bottle labeled “Toxicology – heart from the corpse of L.I. Starchak 1944, certificate No. 191 of 01/14/15, Forensic Medical Expert S.A. Komyshan.” The bottle contained a metal object (**No. 29**);

- a bottle labeled “Toxicology – head from the corpse of L.I. Starchak 1944, certificate No. 191 of 01/14/15, Forensic Medical Expert S.A. Komyshan.” The bottle contained a metal object (**No. 30**);

- a bottle labeled “Toxicology – left shin from the corpse of L.I. Starchak 1944, certificate No. 191 of 01/14/15, Forensic Medical Expert S.A. Komyshan.” The bottle contained a metal object (**No. 31**).

A white makeshift paper bag labeled “corpse of I.O. Kornilov, b. 1984. Four pieces of grey metal. No. 193 dated 01/14/15. Forensic Medical Expert M.A. Laktyonov”, bound along the upper edge by four metal staples, without signs of opening (section 2, ill. 10). The bag contained three metal objects (section 2, ill. 10, **No. 32, 33, 34, and 35**).

A black plastic bag (section 2, ill. 11), the upper part of which was tied with a thread, the ends of which were glued between two parts of a pieces of paper (label) folded in half. The label bore an explanatory text: “pack No. 1-O Witnesses: 1.2. Present 1. I.A. Vervevko. Captain of Justice V. Romanenko, Sr. Special Investigator with the Investigations Department of the Donetsk Regional Directorate of the Security Service of Ukraine” with two signatures, with a note on the reverse side: “Explanatory note, metal fragment, body of N.N. Malakhova” with a signature, without signs of opening. The bag contained a hermetically sealed glass bottle, the top of which was sealed with an adhesive strip labeled “Malakhova/fragm.” The bottle contained a metal object (section 2, ill. 12, **No. 36**)

A black plastic bag (section 2, ill. 13), the upper part of which was tied with a thread, the ends of which were glued between two parts of a pieces of paper (label) folded in half. The label bore an explanatory text: “pack No. 1-O witnesses: 1.2.

Contents:

- a metal fragment measuring around 63 cm in length and around 27 cm in width (section 1, ill. [illegible]);
- a cylindrical metal object measuring around [illegible] in length and around 12 cm in diameter (ill. 10). The object had the following components: [illegible] with a thickness of around 3.5 mm (ill. 10.1) and the marking “881” and [illegible] with a thickness in two places of around 7 and 3.5 mm (section 1, ill. 11 (3 and Russia) [illegible] on the shell were two structural elements: axles and springs (section 1, ill [illegible]). Attached to the shell was a metal plate with a thickness of around 3.5 [illegible] and the marking “60 VII” (section 1, ill. 10, 11, **I**);
- a metal fragment with a length of around 18 cm and a width of up to 8 [illegible] and the marking “T91 VSN” (section 1, ill. 12, **J**);
- a metal fragment measuring around 22 cm in length and up to 6 cm in width (section 1, ill. [illegible], **K**).

A white paper envelope labeled “Pack No. 1 – [illegible] metal fragments (removed from the bus)”; on the reverse side the flap of the envelope was [illegible] paper with the printed note “Research materials for expert opinion No. 74-5, metal fragments. Packed by O. Kocherhin” and a signature, without signs of opening. The pack contained five metal fragments in [illegible] plastic bags numbered “1, 1.01”, “2, 2.51”, 3, 1.15”, 4, 2.81” and “5, [illegible] (section 2 of the table of illustrations, ill. 1, **Objects Nos. 1, 2, 3, 4, and 5**).

A yellow paper pack with the note “Pack No. 3 No. 6 [illegible] post No. 5 of the State Traffic Inspectorate of the Directorate of the Ministry of Internal Affairs of Ukraine”, without signs of opening. The pack contained six metal fragments in separate plastic bags labeled “2.25” [illegible], “2.45”, 2.48”, “3.07”, “20.17”, which were placed in a pack labeled “[illegible] bus” (section 2, ill. 2 and 3, **No. 6, 7, 8, 9, 10, and 11**).

Four hermetically packed glass bottles (section 2, ill. 4) with labels and content:

- a bottle labeled “190” on the cork. Labeled “two fragments from [illegible] V.A. Polyakov. Expert opinion No. 190 of 01/14/15. Forensic Medical Expert E.F. Gorlo (*[illegible] poorly legible*). The bottle contained two metal objects (section 2, ill. 5, **No. 12, 13**, [illegible];
- a bottle labeled “192” on the cork” Labeled “Toxicology [signature] from the corpse of A.A. Morgasyuk. Certificate 192 of 01/14/15 Forensic Medical Expert Syneln[?]. The bottle contained four metal objects (section 2, ill. 5, **Nos. 17, 18, 19, 20** [illegible];
- a bottle labeled “194” on the cork. Labeled “Expert opinion No. 194 of 01/14/15 foreign metal objects from the corpse of Maria Mykaylivna Hrynyk, b. 1965 [illegible] Kubasov”. The bottle contained two metal objects (section 2, ill. 5, **Nos. 21**, [illegible];
- a bottle labeled “195” on the cork. Labeled “three fragments from [illegible] T.V. Morhasyuk, expert opinion No. 195 dated , fragments from the corpse of [illegible] Polyak[?] [illegible]. Expert opinion No. 190 of 01/14/15. Forensic Medical Expert E.G. Horlo (*letter “E” poorly legible*). The bottle contained two metal objects (section 2, ill. 5, **Nos. 21**, [illegible]. The bottle contained three small metal objects (section 2, ill. 5, **No. 14** [illegible]

Two transparent plastic bags, bound by a metal staple (section 2, ill. 4) with the following contents:

[stamp]: [signature] /O.Yu. Koshel/
Security Service of Ukraine
For Expert Examinations #1]

94

O.I. Kovalenko. Present 1. Captain of Justice V. Romanenko, Sr. Special Investigator with the Investigations Department of the Donetsk Regional Directorate of the Security Service of Ukraine” with two signatures, with a note on the reverse side: “Explanatory note, metal fragment from the corpse of A.I. Karpov (ki 15-21)”, without signs of opening. The bag contained a hermetically sealed glass bottle, with a not on a piece of paper glued to the bottle: “Volnovakha Office of Forensic Medical Examinations, foreign body from the corpse of A.I. Karpov, Forensic Medical Expert V.V. Serdyuk. Expert opinion No. 13(6) of 01.15.15”, with the impression of a seal bearing the words: “Volnovakha Office No. 2” (section 2, ill. 14). The bottle contained a metal object (section 2, ill. 14, **No. 37**).

An envelope with an “xDigital” optical disk labelled “BP”, which contained the video recording “1_02_H_150113140000.avi”.

An envelope with an “Axent DVD+R optical disk (serial number MOGXPR-801), which contains a video recording labeled “Video recorder captured shelling of Volnovakha checkpoint.flv”.

In order to systematize the examination of features of the objects, the physical evidence was combined into two groups based on location at the incident site: **group I** – objects that were collected from the epicenters of the blasts, and **group II** – objects that were found outside the epicenters of the blasts.

The phrase “9M22 shell” hereinafter means “unguided M-21 OF rocket-propelled high-explosive fragmentation shell (item 9M22U)”.

1.2. Morphological examination and physical properties

1.2.1. Group I.

All of the objects are fairly deformed. The deformations are typical for the remnants of metallic items formed as a result of an explosion. Traces of thermal influence can be seen on the objects.

Objects A-G are metal fragments—the remnants of items manufactured from sheet metal. They bear the elements of threading on their surfaces, which is obtained by treating metal with pressure and mechanical metal-working, as well as remnants of numerical and alphabetical markings.

In terms of size and weight, objects F and G may be classed as remnants of large metal items (section 1, ill. 6 and 9).

Object H is a unit comprised of several parts with a metal plate (I) attached and bears the remnants of numerical and alphabetical markings. Object J is similar to object I (section 1, ill. 10-12).

Table 1

Weight of objects

Object	A	B	C	D	E	F	G	H	I	J	K
Weight, kg	1.03	0.09	1.39	0.24	0.67	8.84	4.81	4.56	0.09	0.09	0.48

Objects A-H and K have magnetic properties. Rust is present on objects A, B, C, D, and E.

[stamp]: [signature] /O.Yu. Koshel/
Security Service of Ukraine
For Expert Examinations #1]

Objects I and J are non-magnetic and have a density that is typical of non-ferrous alloys and a color that is typical of aluminum alloy coatings.

The materials from which objects A-H and K are made may be classed as iron-carbon alloys.

The materials from which objects I and J are made may be classed as non-ferrous metal alloys.

Objects C, E, F, G, and K and the parts of unit H are coated with metal that is silver-grey to grey in color. The technique used to manufacture the body components of the rocket section of a 9M22 shell involves laying a protective zinc coating [7].

Objects A and D have an identical type of coating, which appears [illegible]-greyish in color. The technique used to manufacture the warhead of a 9M22 shell involves painting the body with an “oil-based wild grey” paint [7, p. [illegible]] (exhibit).

Object B is consistent with part of the body of a warhead from a 9M22 shell with an attached “cover” part with remnants of structural elements [illegible] connecting thread, its placement, and the thickness of the fragment ([7, p. 227], [illegible] section 1, ill. 3).

1.2.2. Group II.

Objects Nos. 1-37 all have traces of a powerful external mechanical influence of a dynamic and pulsed explosive nature (blast wave) [illegible] characterized by mechanical damage (of varying degrees) as a result of contact with an obstacle and traces of thermal influence (section 3 of the table of illustrations, ill. 1-4).

The objects have magnetic properties and are covered in rust.

Objects Nos. 1, 3, 14-16, 21, 22, 24-26, 28, 29. and 31-33 do not have clear geometric shapes, and several of the objects are flat. These objects have a weight [illegible] 1.15 g (Table 3) and are classed as pieces of metal (alloy).

Metal objects Nos. 11, 23, 35 and 37, weighing from 2 to 20 g (Table 2) [illegible] have traces of pulsed and dynamic explosive load and may [illegible] classified as fragments of metal items.

Table [illegible]

Weight of objects

Object No.	1	3	11	14	15	16	21	22	23	24	25	26	[illegible]
Weight (g)	0.51	0.69	20.4	0.03	0.02	0.06	0.22	0.06	4.72	1.15	0.29	0.32	[illegible]

Object No.	29	31	32	33	35	36	37
Weight (g)	0.51	0.75	0.16	0.12	6.87	0.57	2.33

Objects Nos. 2, 4-10, 12, 13, 17-20, 27, 30 and 34 (17 items in total) are metal fragments with rusty edges and show mechanical damage as a result of dynamic contact interaction with an obstacle (section 4 of the table of illustrations, ill. 1 and 2).

These objects are characterized by the presence of remnants of diamond shapes (section 4, ill. 1 and 2). On the surface along the rusty edge there are ruffles* that cross at angles of around 60° and 120°. These ruffles are a shape-forming element (ill. 1).

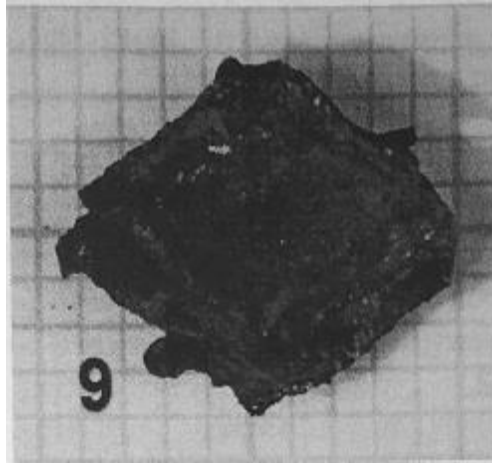

Illustration 1.

The aforementioned objects are characterized by close thickness. For the least deformed fragments, the average metal thickness is 2.4 mm (Table 3).

Table 3

Fragment thickness

Object number	4	5	6	7	10	Average thickness (mm)
Thickness (mm)	2.3	2.6	2.5	2.2	2.3	2.4

Table 4

Weight of diamond-shaped fragments

Object number	2	4	5	6	7	8	9	10	12	13	17	18	19	20	27	30	34
Weight (g)	2.04	2.33	2.16	2.26	2.31	2.45	2.5	3.08	2.16	2.08	2.15	1.94	2.06	2.06	2.51	2.01	1.66

The average weight of the diamond-shaped objects is 2.22 g (Table 4).

The form, dimensions, and weight of objects of this group and the indications of the manufacturing techniques used to produce the metal parts from which the objects were derived are consistent with the parameters of destructive agents formed as a result of the explosive rupture of the “inner bushing” and “outer bushing” of a 9M22 shell warhead [7, p.237, 238, and information from Splav Research and Production Association] (exhibit).

Note. *Ruffles in this context are depressions formed on the surface as a result of pressure-treating metal

[stamp]: [signature] /O.Yu. Koshel/
Security Service of Ukraine
For Expert Examinations #1]

The diamond-shaped objects show irregular distribution of corrosion. The technical documentation provides for phosphatizing the parts of a 9M22 shell from which the pre-formed fragments are obtained [7, p. 237, 238].

Phosphate coating quality control is done by visual inspection and by testing for corrosion resistance (the drop method) [17]. The presence of coating on the flat surfaces of the diamond-shaped objects is determined visually. In order to clarify whether there are remnants of protective phosphate coating for Objects Nos. 6, 4 and 20, their surfaces were analyzed with a scanning electron microscope. The obtained data indicated that the metal objects were coated with substances that had elevated phosphate content in certain sections (section 5, ill. 1). However, reliable data were not obtained as to the presence of an overall protective coating.

In terms of their parameters—geometric characteristics, weight and methods of treatment—Objects Nos. 2, 4-10, 12, 13, 17-20, 27, 30 and 34 all belong to the same category and match the parameters of destructive elements obtained as a result of the explosive separation (explosion) of the “inner bushing” and “outer bushing” of a 9M22 shell warhead.

1.3. Identification of chemical composition. Metallographic analysis.

The elemental composition of the substance submitted for examination was calculated to be in the range of atomic numbers from 12Mg to 92U using the non-destructive method of X-ray fluorescence (XRF) on an EXPERT-02L energy-dispersive analyzer of elemental composition. Pamyр-M x-ray tube operating mode: voltage 45.9 kV, exposure time 300s. The characteristic x-ray radiation was recorded by a Moxtek PF-550 Si-pin detector with a rated capacity of 180 eV on the MnK α -line. The flat surface of the metal objects was polished in order to perform the XRF. Their chemical composition was determined using the EXPERT 02L software applications.

The carbon content on an optical emission spectrometer was determined for objects that had sufficient mass and dimensional parameters for this method. For objects with a “small” mass (Table 2) the carbon content was calculated by metallographic means.

1.3.1. Group I.

The chemical composition of the iron-carbon objects of unit H was not examined, since according to the findings of Section 1.2 and expert examination No. 18/4-2197 of the Institute for Special Equipment and Forensic Expert Examinations dated 03/26/2015 based on the files of criminal proceeding No. 2201505000000021, objects H(I) and J are components of the stabilizer unit of a 9M22U shell. The unit’s basic parts (object H) are composed of “steel 10” and “40X” grade steels. Objects I and J are remnants of parts of “stabilizer blades”, and their material is aluminum alloy AMg5 [6].

The results of the examination of objects A-K to determine the composition of their chemical elements (by x-ray fluorescence and emission spectrometry) are provided in Table 5.

Based on the fact that the aforementioned expert examination (No. 18/4-2197 of the SBU Institute for Special Equipment and Forensic Expert Examinations dated 03/26/2015) determined that objects A and B previously formed one whole and that objects C and E previously formed one whole, the carbon content for objects A and C was determined (in Table 5, the same carbon content is indicated for A and B, and for C and E).

Table 5

Chemical composition								
Object No.	Weight part of chemical element, %							
	C	Si	P	S	Cr	Mn	Ni	Cu
A	0.15	0.34	0.018	0.022	0.09	0.78	0.61	0.09
B	0.15	0.32	0.020	0.025	0.09	0.79	0.63	0.09
C	0.15	0.33	0.022	0.021	0.09	0.80	0.62	0.11
D	0.16	0.31	0.025	0.016	0.09	0.79	0.63	0.10
E	0.15	0.28	0.018	0.024	0.08	0.80	0.64	0.10
F	*	0.36	0.027	0.017	0.13	0.85	0.57	0.08
G	*	0.43	0.018	0.024	0.17	0.84	0.50	0.07
K	0.17	0.36	0.020	0.016	0.12	0.83	0.65	0.07
Grade composition[10-12]								
Steel 10GN	0.11-0.15	0.30-0.50	<0.025	<0.030	<0.20	0.60-0.90	0.60-0.90	<0.20

* - carbon content was not determined

Based on the content of their main and impurity chemical elements, the fragments submitted for examination (A-K, except unit H) are of the same type in terms of the type of material from which they were manufactured: structural carbon steel (Table 5). The steel that was used to manufacture the items from which these objects were obtained matches the composition of 10GN(A)-grade steel (structural high-grade alloyed steel) [10-12].

10GN-grade steel is used to produce the “main tube” and “tail tube” of a 9M22U shell [6]. The submitted documentation indicates that the same grade of steel is used to produce the “shell body” of a 9M22 warhead shell as the “main tube” and “tail tube” (per Iron and Steel Technical Standard 627-62 of the Central Scientific Research Institute for the Iron and Steel Industry) [7 and 6, p.236, 258, 262] (exhibit). ***Thus, the “shell body”, “main tube” and “tail tube” of a 9M22 shell may be manufactured from the same grade of steel, i.e., 10GN(A)-grade steel.***

The results of the examination of objects I and J to determine the composition of their chemical elements by x-ray fluorescence are provided in Table 6.

[stamp]: [signature] /O.Yu. Koshel/
Security Service of Ukraine
For Expert Examinations #1]

Chemical composition

Object No.	Weight part of chemical element, %							
	Si	Fe	Cu	Mn	Mg	Cr	Zn	Ti*
I	0.26	0.33	0.06	0.55	5.42	0.09	0.05	<0.002
J	0.40	0.34	0.05	0.58	5.6	0.09	0.06	<0.001
Grade composition [13]								
AMg5	<0.5	<0.5	<0.1	0.30–0.8	0.48–5.8	–	<0.2	0.02–0.1

*titanium may be replaced with boron or other modifiers

Based on the content of their main and impurity chemical elements, fragments I and J are of the same type of aluminum alloys. In terms of the chemical composition, the alloy from which fragments I and J were manufactured matches AMg5-grade alloy. AMg5 alloy is used to produce the “unit stabilizer blades” [6].

1.3.2. Group II.

The carbon content of the group of diamond-shaped objects was determined by emission spectrometry for 8 randomly selected objects and by metallographic means for 4 (Table 6).

In terms of structure, the objects in Tables 6 and 7 from which the polished sections were prepared may be classed as hypoeutectoid steels. Therefore, carbon content was specifically calculated for these objects using the method of quantitative metallography [1]. The metallographic images are provided in section 6 of the table of illustrations. Based on the reference data, the carbon content is estimated to be within the range of 0.1-0.2% [15].

The results of the examination of the diamond-shaped objects to determine the composition of their chemical elements (by x-ray fluorescence and emission spectrometry methods) are provided in Table 6.

Table 6

Chemical composition of the diamond-shaped objects

Object No.	Weight part of chemical element, %							
	C	Si	P	S	Cr	Mn	Cu	Ni
2	0.1-0.2*	0.19	0.019	0.046	0.02	0.57	0.01	–
4	–	0.18	0.018	0.035	0.02	0.58	–	–
5	0.17	0.21	0.018	0.022	0.02	0.56	–	–
6	0.1–0.2*	0.21	0.017	0.029	0.02	0.61	0.01	–
7	0.14	0.25	0.019	0.026	0.01	0.53	–	–
8	–	0.20	0.028	0.017	0.01	0.57	0.03	–
9	–	0.21	0.030	0.014	0.02	0.57	0.03	–
10	–	0.19	0.032	0.030	0.02	0.51	0.01	0.02
12	0.16	0.21	0.026	0.045	0.02	0.58	0.02	–
13	0.13	0.23	0.020	0.046	0.01	0.55	–	–
17	0.15	0.27	0.024	0.028	0.01	0.56	0.01	0.02

Object No.	Weight part of chemical element, %							
	C	Si	P	S	Cr	Mn	Cu	Ni
18	0.16	0.18	0.022	0.038	0.02	0.58	–	–
19	0.1-0.2	0.19	0.014	0.023	0.02	0.55	–	–
20	–	0.24	0.021	0.037	0.02	0.59	0.01	–
27	0.13	0.20	0.022	0.027	0.02	0.57	0.01	0.02
30	0.15	0.19	0.016	0.022	0.02	0.56	0.01	–
34	0.1-0.2*	0.21	0.019	0.027	0.02	0.55	0.00	–
Grade composition[11]								
St2sp	0.09-0.15	0.15-0.30	<0.04	<0.05	<0.3	0.25-0.50	≤ 0.3	≤ 0.3
St3sp	0.14-0.22	0.15-0.30				0.40-0.65		

* - carbon content calculated by metallographic means

Based on analysis of the obtained data (Table 6), *the diamond-shaped objects do not contain alloying elements and, in terms of their chemical composition, may be classed as structural carbon steels. In terms of the weight part of the main and impurity chemical elements, the steel from which they were made matches St2(sp)- and St3(sp)-grade steel [8].*

The technical documentation for the manufacture of the “inner bushing” and “outer bushing” components of a 9M22 shell warhead standardizes the use of St3(sp)-steel [6 and 7, p. 237, 238] (exhibit).

In terms of their composition, objects Nos. 2, 4-10, 12, 13, 17-20, 27, 30 and 34 match St3(sp)-grade steel, which is used to obtain the pre-formed destructive agents of a 9M22 shell.

The results of the identification of the chemical composition (by x-ray fluorescence, spectrometry and metallography methods) of other fragments from the group of objects that were found outside the epicenters of the explosions are provided in Table 7

Table 7

Object No.	Weight part of chemical element, %							
	C	Si	P	S	Cr	Mn	Cu	Ni
1	0.1-0.2*	0.05	0.024	0.012	0.04	0.42	0.02	–
24		0.02	0.024	0.021	0.02	0.40	0.05	–
25		0.04	0.048	0.018	0.04	0.34	0.04	–
26		0.03	0.040	0.023	0.03	0.38	0.03	–
31		0.04	0.028	0.031	0.02	0.38	0.04	–
33		0.05	0.083	0.030	0.03	0.38	0.06	–
36		0.04	0.023	0.020	0.03	0.35	0.02	–

[stamp]: [signature] /O.Yu. Koshel/
 Security Service of Ukraine
 For Expert Examinations #1]

Object No.	Weight part of chemical element, %							
	C	Si	P	S	Cr	Mn	Cu	Ni
3	0.1-0.2*	0.11	0.026	0.049	0.04	0.42	0.02	–
14		0.55	0.038	0.039	0.18	0.59	0.20	0.04
15		0.35	0.146	0.110	0.04	0.52	0.05	0.01
6		0.81	0.043	0.012	0.02	0.56	0.01	–
22		0.34	0.023	0.027	0.18	0.59	0.19	0.04
32		0.29	0.055	0.042	0.16	0.56	0.16	0.04
21		0.20	0.022	0.020	0.02	0.53	0.02	–
28		0.20	0.038	0.046	0.02	0.56	0.07	–
29		0.19	0.029	0.058	0.02	0.56	0.02	–
11	0.12	0.25	0.037	0.025	0.14	0.56	0.17	0.07
23	0.13	0.23	0.027	0.027	0.16	0.61	0.16	0.04
35	0.11	0.28	0.038	0.030	0.16	0.60	0.18	0.04
37	0.13	0.28	0.032	0.032	0.16	0.61	0.16	0.03
Grade composition [14, 15, 17]								
BSt2kp	0.09-0.15	≤ 0.07	≤ 0.04	≤ 0.05	≤ 0.3	0.25-0.50	≤ 0.3	≤ 0.3
BSt3kp	0.14-0.22					0.30-0.60		
BSt3(sp)	0.14-0.22					0.12-0.30		
St2(sp)	0.09-0.15	0.15-0.30	≤ 0.04	≤ 0.05	≤ 0.3	0.25-0.50	≤ 0.3	≤ 0.3
St3(sp)	0.14-0.22	0.15-0.30				0.40-0.65		
BSt3(sp)	0.14-0.22	0.12-0.30	≤ 0.04	≤ 0.05	≤ 0.3	0.40-0.65	≤ 0.3	≤ 0.3
08kp	0.05-0.11	≤ 0.03	≤ 0.035	≤ 0.04	≤ 0.10	0.25-0.50	≤ 0.25	≤ 0.25
10kp	0.07-0.14	≤ 0.03			≤ 0.15	0.35-0.65		
Steel 10	0.07-0.14	0.17-0.37						

* - carbon content calculated by metallographic means

Objects Nos. 1, 24, 25, 26, 31, 33, and 36, in terms of the content of their main and impurity chemical elements (Table 7), are of the same type of structural carbon steel, and their composition is consistent with steel grades St2kp, St3kp, 08kp, and 10kp [14, 16]. Steel grades 08kp and 10kp are used to manufacture the MRV-U burster tube of a 9M22 shell [7] (exhibit).

Object No. 3, in terms of the composition of its chemical elements, is consistent with steel grades St3 and BSt3 (Table 7). The technical documentation provides for the use of BSt3-grade steel to manufacture the “large ring” and “small ring” components of a 9M22 shell [6, 7] (exhibit).

Based on chemical composition data and metallographic analysis, objects Nos. 14, 15 and 16 may be classed as low-carbon structural steels.

Objects Nos. 22 and 32, in terms of their main and impurity chemical elements (Table 7) are of the same type of structural carbon steel, and their composition is consistent with steel grade St3. The objects have the same average weighted ferritic-pearlitic structure (see section 6 of the table of illustrations).

Objects Nos. 11, 23, 35 and 37, in terms of their main and impurity chemical elements (Table 7) are of the same type of structural carbon steel, and their composition is consistent with steel grade “steel 10.” The technical documentation provides for the use of “steel 10” steel for the manufacture of a “cover/nozzle” component [6].

Objects Nos. 21, 28 and 29, in terms of their main and impurity chemical elements (Table 7) are of the same type of structural carbon steel, and their composition is consistent with St3(sp)-grade steel. Based on the results of a metallographic analysis, their structure is of the same type as the destructive pre-formed agents (diamond-shaped objects). To summarize the obtained data, we find that *these objects (Nos. 21, 28 and 29) are fragments of the “bushing” of a 9M22 shell.*

Literature:

1. Shcherbakovsky, M.G. *Criminalistic Examination of Metals, Alloys and Items Made from Them*. A Practical Research Guide for Experts: Kyiv: Osnova, 1996 – 116 p.;
2. Epshteyn, G.N. *The Construction of Metals Deformed by Explosion*: Moscow: Metallurgia, 1980. – 255 p.
3. *Explosives Expert Book: A Study Guide and Methodological Handbook*: Moscow: Publishing House of the Criminalistics Institute of the Federal Security Service of the Russian Federation, 2001 – 356 p.: ill.
4. Gulyayev, A.P. *Metal Science: A Textbook*. Moscow, Metallurgia, 1977 – 647 p.
5. *Materials Science: A Handbook* / Ye.H. Aftandilyants, O.V. Zazymko, K.H. Kopatko / Kherson: OLDI-PLUS, 2012 – 612 p.
6. Letter No. 679k/upr of 03/25/2015 from Ukroboronprom SC State Scientific Research Institute for Chemical Products (exhibit)
7. Letter No. 992 of 04/01/2015 from Military Unit A1201 of the Ministry of Defense of Ukraine
8. *Grade Guide to Steels and Alloys* / under the general editorship of A.S. Zubchenko, 2nd Edition, Revised and Updated / Moscow: Mashinostroyeniye, 2003 – 784 p.
9. Recommended methods for testing opium/crude morphine. Vienna, Austria: United Nations, Division of Narcotics Drugs [sic] . 1987
10. Technical specification TU 14-1-2376-78. 10GN-grade hot-rolled steel in rings. Technical specifications.
11. Technical specification TU 14-1-1251-75. Pipe billet from 10GN-grade steel.
12. Technical specification TU 1-1365-75. Pipe billet from 10GN-grade steel.
13. Technical specification GOST 4784-74. Deformed aluminum and aluminum alloys. Grades.
14. Technical specification GOST 380-71. Standard-quality carbon steel. Grades and general technical requirements.
15. Technical specification GOST 380-71. Standard-quality carbon steel. Grades and general technical requirements.
16. Technical specification GOST 8233-56. Steels. Structural standards.
17. Technical specification GOST 1050-74. High-quality structural carbon steel. Technical specifications.
18. Grilekhes, S.Ya. Protection of Metals with Oxide and Phosphate Coatings. Issue 9 from the “Electroplater’s Library” series: Moscow: Mashgiz, 1961 – 77 p.

[stamp]: [signature] /O.Yu. Koshel/

Security Service of Ukraine
For Expert Examinations #1

Equipment details:

The measuring devices and testing equipment used in the laboratory examinations conform to the certification and calibration testing requirements of Law of Ukraine No. 113/98-VR of 02/11/98 “On Metrology and Metrological Activity” (as amended). The following were used in the examinations: NIKON SMZ1500 stereomicroscope, MBS-10 optical microscope, Sartorius AC 210S electronic scales No. 24707518 (calibration testing certificate No. 35-02/1220008 dated 01/14/2013), Ladoga-U SVP-60-5 GOST 5639-82 scales, ShTs-125-01.1-2 GOST 166-89 caliper, EXPERT 02L x-ray fluorescence analyzer of chemical element content No. 27/2004 (calibration testing certificate No. 12-02/1715 dated 11/14/2014), DFS-36-1800 optical emission spectrometer (calibration testing certificate No. 37/0220 dated 01/14/2014), TESCAN LYRA 3 scanning electron microscope, and OLYMPUS GX51 metallographic microscope.

Note.

All of the metal objects were damaged to varying degrees during the examinations.

After the examinations, the objects were packed into numbered plastic zip-lock bags. The large objects were packed into two sacks.

The research materials were packed into one envelope (the flap of which was sealed with fragments of paper), a plastic bag, and two sacks, the necks of which were bound with white threads, the ends of which were sealed with fragments of paper, all of which bore imprints of the seal “For physical evidence, research objects and samples, No. 7, Security Service of Ukraine” and expert signatures.

Synthesizing section**For the objects from the epicenters of the explosions (group I).**

Based on their technological and structural features, Objects A and D may be, and Objects B, C, E, F, G, H (I), J, and K are, remnants of components and units of an M-21OF (9M22U) shell.

Objects A-K (except H(I) and J) are of the same type in terms of their chemical composition. The material used to manufacture the parts from which they were obtained is 10GN(A)-grade steel, which is used to manufacture the warhead “shell body,” “main tube,” and “tail tube” of an M-21OF (9M22U) shell.

Objects I and J are of the same type in terms of their chemical composition and are made from AMg5 aluminum alloy, which is consistent with the material used to make “stabilizer unit blades.”

Thus, the above combination of features and characteristics gives us grounds to conclude that among the Group I objects:

- objects A, B, and D are remnants of the “shell body” of an M-21OF (9M22U) shell warhead;
- objects C, E, F, G, and K are remnants of the “main tube” and “tail tube” of an M-21OF (9M22U) shell;

- objects (H, I, and J) are remnants of the “stabilizer unit” of an M-21OF (9M22U) shell.

For the objects that were collected outside the epicenters of the explosions (fragments that were located outside the epicenters of the explosions – group II).

Findings regarding the diamond-shaped objects (objects Nos. 2, 4-10, 12, 13, 17-20, 27, 30, and 34).

In terms of their geometric characteristics, weight and manufacturing techniques, these objects are consistent with the parameters of destructive elements obtained as a result of the explosive separation of the “inner bushing” and “outer bushing” of the warhead of an M-21OF (9M22U) shell.

These objects share a common composition consistent with St3(sp)-grade steel, which is used to manufacture the “inner bushing” and “outer bushing” of the warhead of an M-21OF (9M22U) shell.

In summary, based on the above data, we conclude that Objects Nos. 2, 4-10, 12, 13, 17-20, 27, 30 and 34 are destructive agents of an M-21OF (9M22U) shell.

Findings regarding the other fragments from the group of objects that were located outside the epicenters of the explosions.

These objects do not have defining (signaling) morphological features.

Objects Nos. 1, 24, 25, 26, 31, 33, and 36, in terms of the composition of their chemical elements, are all of the same type, and their composition is consistent with steel grades St2kp, St3kp, 08kp, and 10kp. These objects may be fragments of the MRV-U burster tube of an M-21OF (9M22U) shell.

Object No. 3, in terms of the composition of its chemical elements, is consistent with steel grades St3 and BSt3. It may be a fragment from the “large ring” or “small ring” of an M-21OF (9M22U) shell.

Objects Nos. 14, 15 and 16 may be classed as low-carbon structural steels.

Objects Nos. 22 and 32, in terms of the composition of their chemical elements, are both of the same type, and their composition is consistent with steel grade St3.

Objects Nos. 11, 23, 35, and 37, in terms of the composition of their chemical elements, are of the same type of structural carbon steel, and their composition is consistent with steel grade “steel 10.” These objects may be fragments of the “cover/nozzle” component of an M-21OF (9M22U) shell.

Objects Nos. 21, 28 and 29, in terms of their content, are of the same type, and their composition is consistent with St3(sp)-grade steel. Their structure is of the same type as the diamond-shaped objects. To summarize the obtained data, we find that ***these objects are fragments of the “bushing” of an M-21OF (9M22U) shell.***

[stamp]:
Security Service of Ukraine [signature] /O.Yu. Koshel/
For Expert Examinations #1

CONCLUSIONS

1-4. The objects submitted for examination (except objects I and J) are made of low-carbon structural steels. Objects I and J are made of aluminum alloy. The objects are of the same type in terms of the material used to manufacture the parts from which these objects were derived.

For 48 of the objects submitted for examination, the examination results made it possible to identify the grades of steel and relevant components of an unguided M-21OF (9M22U) rocket-propelled high-explosive fragmentation shell.

For 11 of the objects that were collected from the epicenters of the explosions, it was established that:

- 8 objects (A, B, C, D, E, F, G, and K) were made from 10GN steel, which is used to manufacture the shell body components of an M-21OF (9M22U) shell. Objects A, B, and D are remnants of the warhead shell “body” of an M-21OF (9M22U) shell, while objects C, E, F, G, and K are remnants of the “main tube” and “tail tube.”

- three objects (H (I) and J) came from the stabilizer unit of an M-21OF (9M22U) shell, the components of which are manufactured using 40X steel, 10 steel, and AMg5 steel (I and J).

For 37 fragments that were located outside the epicenters of the explosions, it was found that:

- 7 objects (1, 24, 25, 26, 31, 33, and 36) are remnants of components whose material is consistent with St2kp, St3kp, 08kp and 10kp-grade steels;

- 22 objects are remnants of components made from St3 steel (Nos. 2, 4-10, 12, 13, 17-21, 27-30, and 34);

- the composition of one object (No. 3) is consistent with steel grades St3 and BSt3;

- four objects are remnants of components that are manufactured from “steel 10” steel (Nos. 11, 23, 35, and 37).

In terms of the material from which they were manufactured, these 34 objects are consistent with the grade composition of steels used to manufacture the components of an M-21OF (9M22U) shell.

For three objects (Nos. 14, 15, and 16), we conclude that they are low-carbon structural steels and are made of a material that can be used to manufacture parts for an M-21OF (9M22U) shell.

Based on the results of the examination of these 37 objects, we also conclude that they came from components of an unguided M-21OF (9M22U) rocket-propelled high-explosive fragmentation shell:

- 20 objects are pre-formed destructive agents of an M-21OF (9M22U) shell (Nos. 2, 4-10, 12, 13, 17-20, 27. 30, 34, 21, 28, and 29);

- 7 objects may be fragments of the MRV-U burster tube of an M-21OF (9M22U) shell (Nos. 1, 24, 25, 26, 31, 33, and 36);

- four objects may be fragments of the cover/nozzle component of an M-21OF (9M22U) shell (Nos. 11, 23, 35, and 37);

- one object (No. 3) may be a fragment of the “large ring” or “small ring” of an M-21OF (9M22U) shell.

Of the 26 fragments that struck people (Nos. 12-37), 12 fragments (Nos. 12, 13, 17-21, 27-30 and 34) were identified as pre-formed destructive agents of shell (obtained as a result of the explosive rupture of the “inner bushing” and “outer bushing” components of the warhead of an unguided M-21OF (9M22U) rocket-propelled high-explosive fragmentation shell.

Expert:**Candidate of Technical Sciences** [signature] **O. Koshel**

[stamp]:

Security Service of Ukraine

For Expert Examinations #1

[stamp]:

Ukrainian Scientific Research Institute for
Special Equipment and Forensic Expert
Examinations of the Security Service of Ukraine

Ref. No. 18/4-3392

[text cut off]

104

SECURITY SERVICE OF UKRAINE
TABLE OF ILLUSTRATIONS
TO EXPERT OPINION No. 16/8 of 05/07/2015

1. Objects collected from the explosion sites
The numbering that was used in the research is placed on the photos of the objects.



Pack No. 1
Research materials
No. 220150500000000021
- 5 metal objects
Packed by:

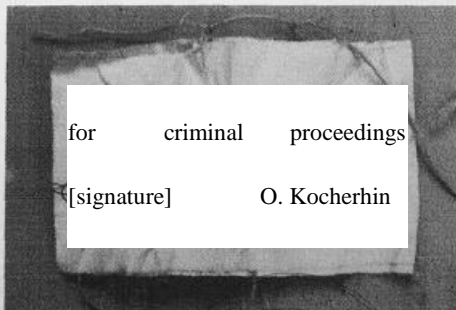

Illustration 1: External view of packaging of material evidence (sack) No. 1

Expert:

[stamp]:
Security Service of Ukraine
For Expert Examinations #1

[signature] O. Koshel

SECURITY SERVICE OF UKRAINE
TABLE OF ILLUSTRATIONS
TO EXPERT OPINION No. 16/8 of 05/07/2015

Pack No. 1
Research materials
No. 2201505000000021
- 5 metal objects
Packed by:

Pack No. 3
Witnesses 1
2
Present
*Senior Lieutenant of Justice, Senior Investigator with
the Investigations Department of the Donetsk
Regional Directorate of the Security Service of
Ukraine* [signature] O. Starostenko

Illustration 1 (continued). Packing labels (sack) No. 1

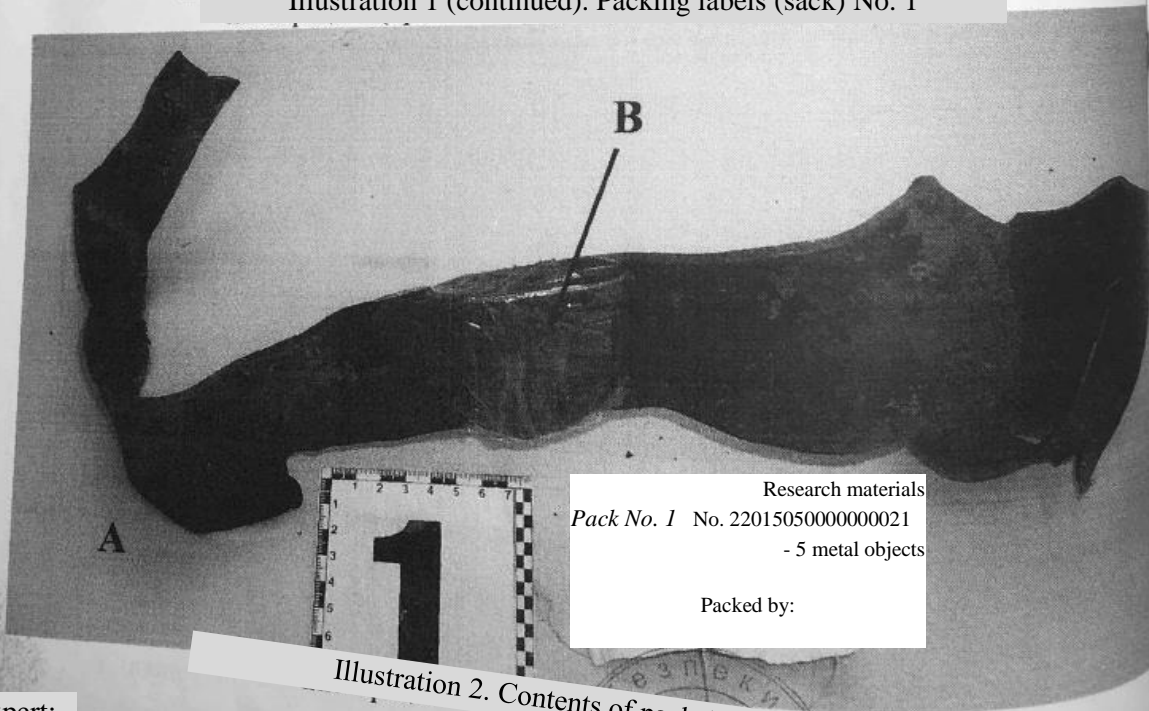

Research materials
Pack No. 1 No. 2201505000000021
- 5 metal objects
Packed by:

Expert:

Illustration 2. Contents of pack (sack) No. 1

[stamp]:
Security Service of Ukraine
For Expert Examinations #1
[signature] O. Koshel

SECURITY SERVICE OF UKRAINE
TABLE OF ILLUSTRATIONS
TO EXPERT OPINION No. 16/8 of 05/07/2015

105

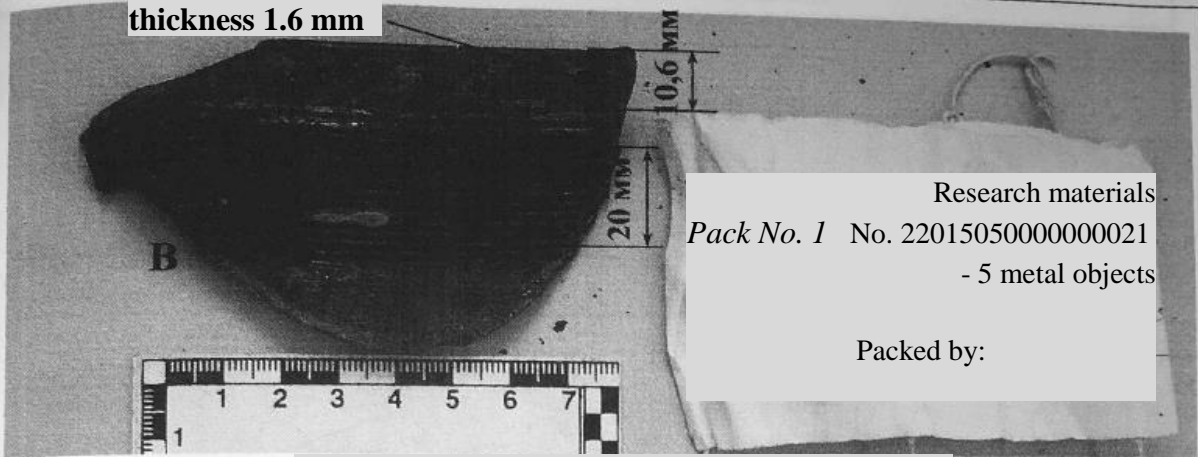

Illustration 3. Contents of pack (sack) No. 1

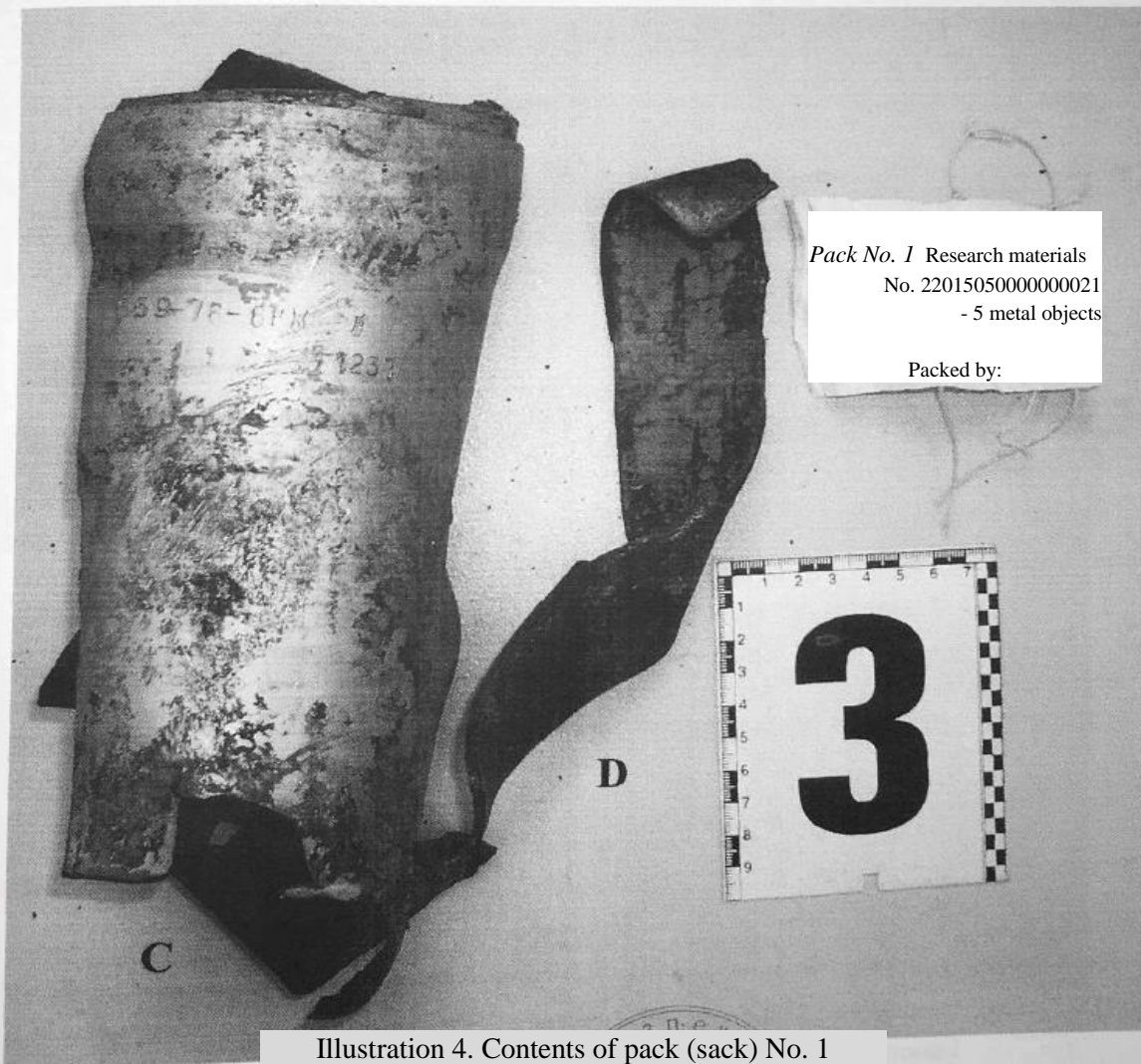

Illustration 4. Contents of pack (sack) No. 1

Expert: _____

[stamp]:
Security Service of Ukraine
For Expert Examinations #1

[signature] O. Koshel

SECURITY SERVICE OF UKRAINE
TABLE OF ILLUSTRATIONS
TO EXPERT OPINION No. 16/8 of 05/07/2015

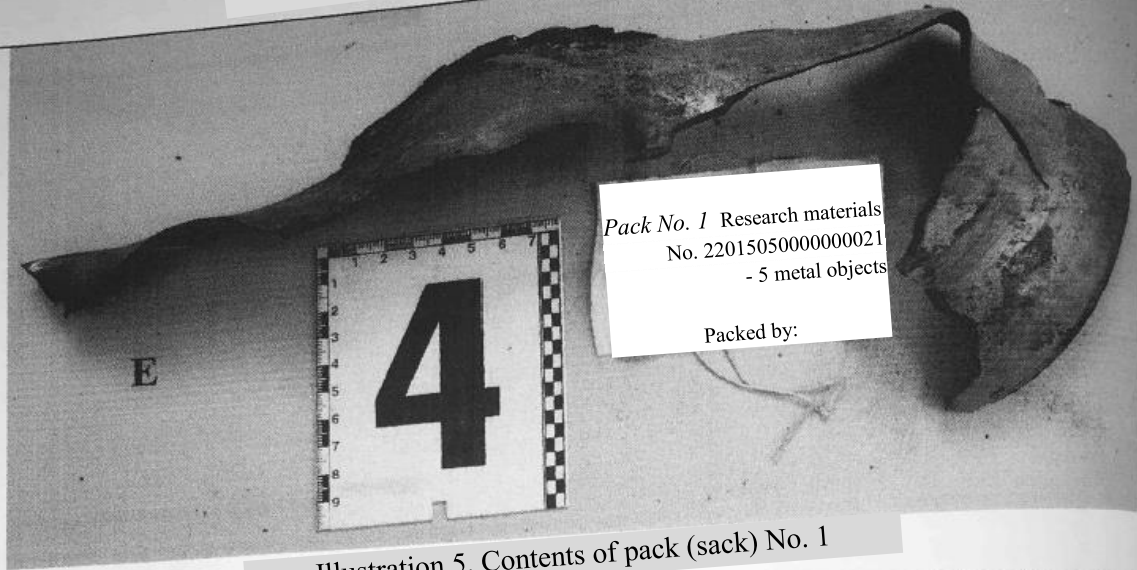

Illustration 5. Contents of pack (sack) No. 1



Illustration 6. Contents of pack (sack) No. 1

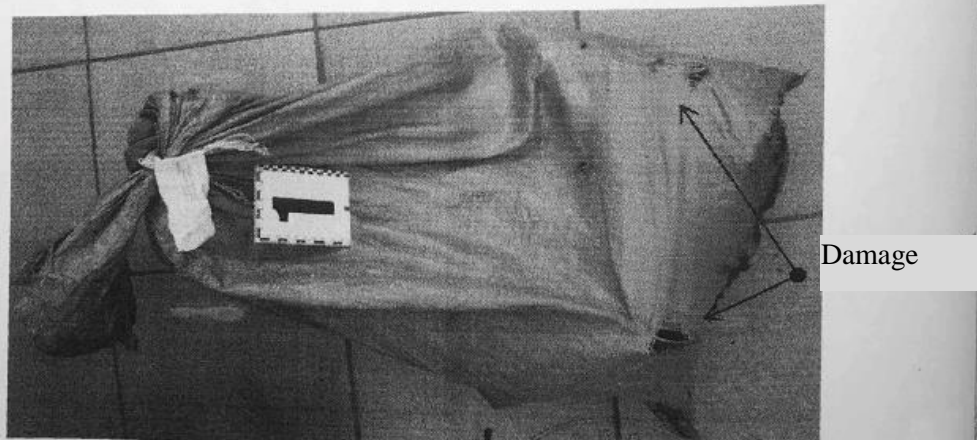

Illustration 7. External view of packing of physical evidence (sack) No. 2

Expert:

[stamp]:
Security Service of Ukraine
For Expert Examinations #1

[signature] O. Koshel

105

SECURITY SERVICE OF UKRAINE
TABLE OF ILLUSTRATIONS
TO EXPERT OPINION No. 16/8 of 05/07/2015

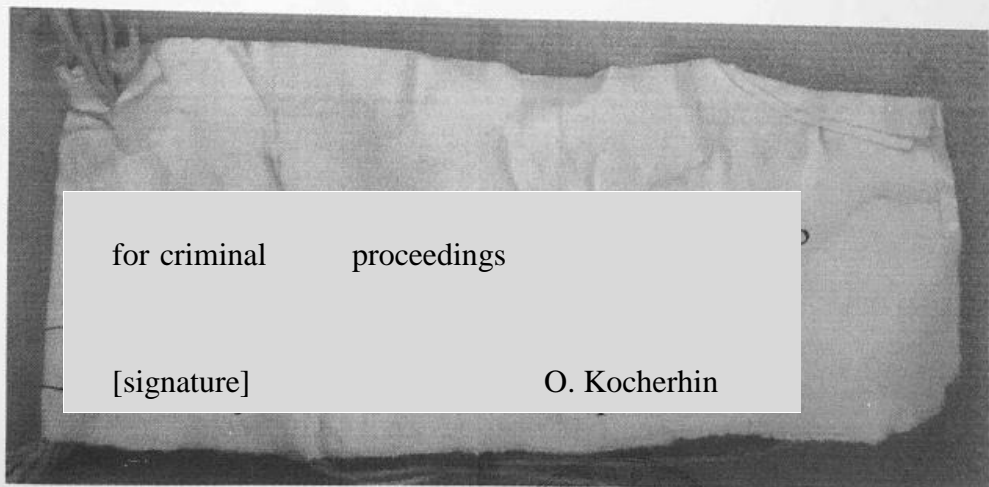
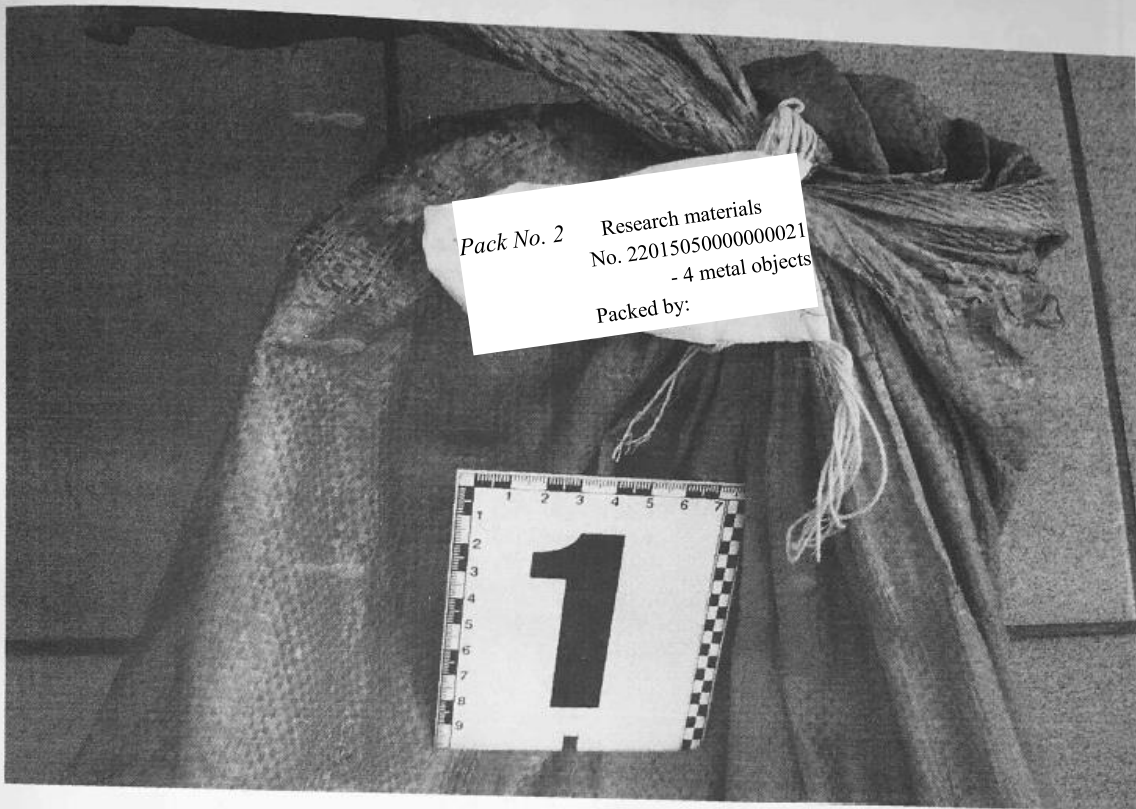

for criminal proceedings

[signature] O. Kocherhin

Illustration 8. External view of packing of physical evidence (sack) No. 2

Expert:

[stamp]:
Security Service of Ukraine [signature] O. Koshel
For Expert Examinations #1

SECURITY SERVICE OF UKRAINE
TABLE OF ILLUSTRATIONS
TO EXPERT OPINION No. 16/8 of 05/07/2015



Illustration 9. Contents of pack (sack) No. 2

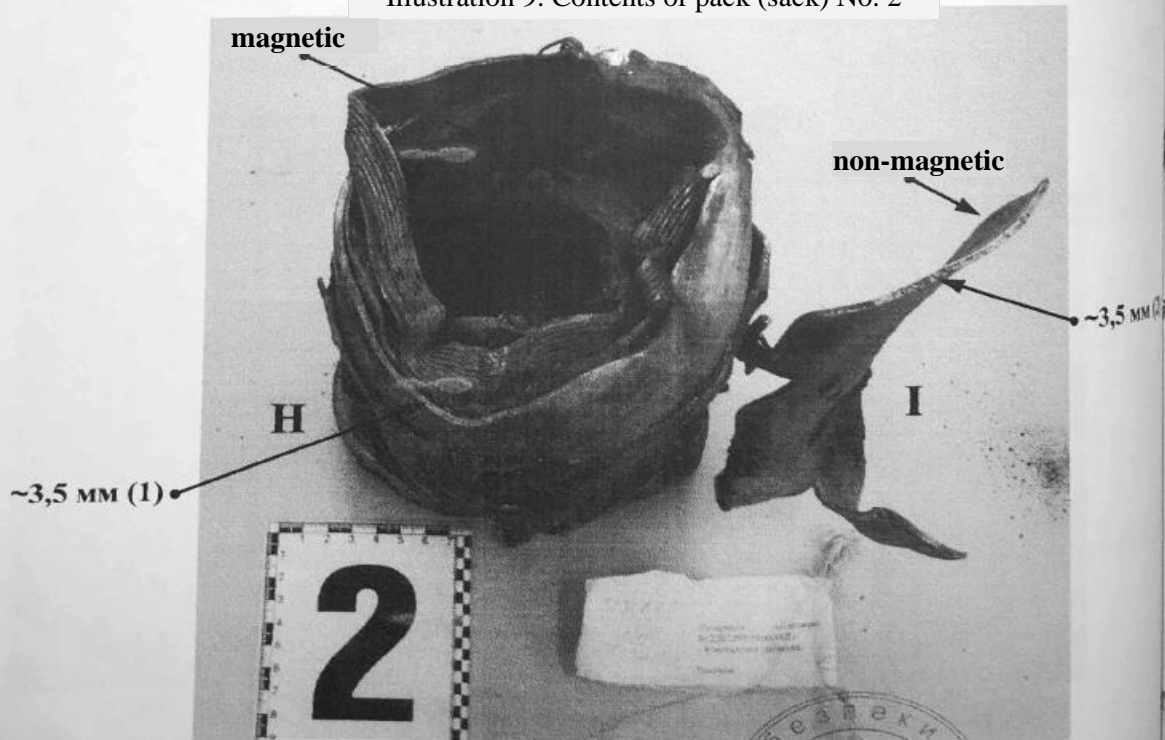

Illustration 10. Contents of pack (sack) No. 2

Expert:

[stamp]:

[signature] O. Koshel

Security Service of Ukraine
For Expert Examinations #1

SECURITY SERVICE OF UKRAINE
TABLE OF ILLUSTRATIONS
TO EXPERT OPINION No. 16/8 of 05/07/2015

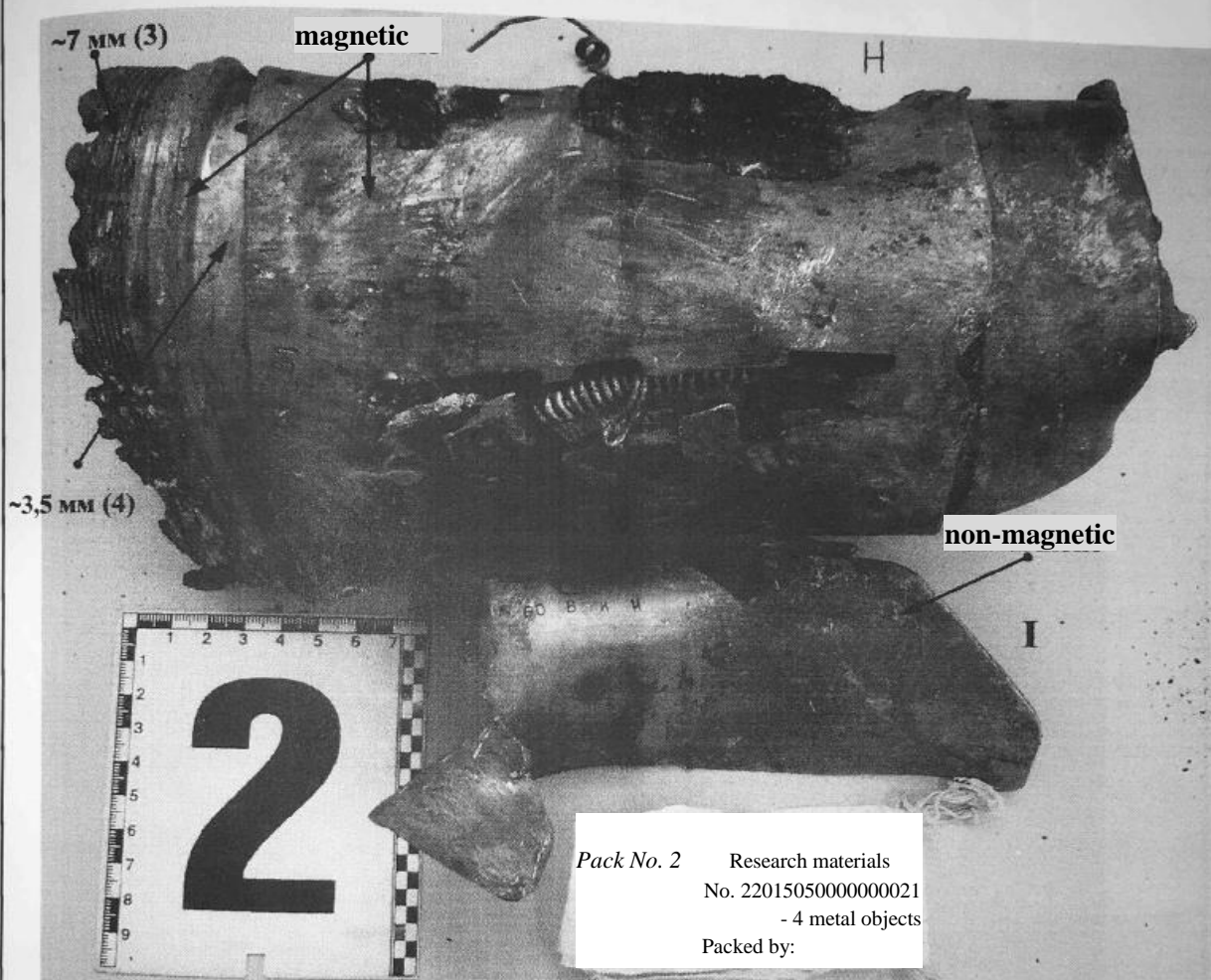

Pack No. 2 Research materials
 No. 2201505000000021
 - 4 metal objects
 Packed by:

Illustration 11. Contents of pack (sack) No. 2

[stamp]:
 Security Service of Ukraine
 For Expert Examinations #1

[signature] O. Koshel

Expert:

SECURITY SERVICE OF UKRAINE
TABLE OF ILLUSTRATIONS
TO EXPERT OPINION No. 16/8 of 05/07/2015

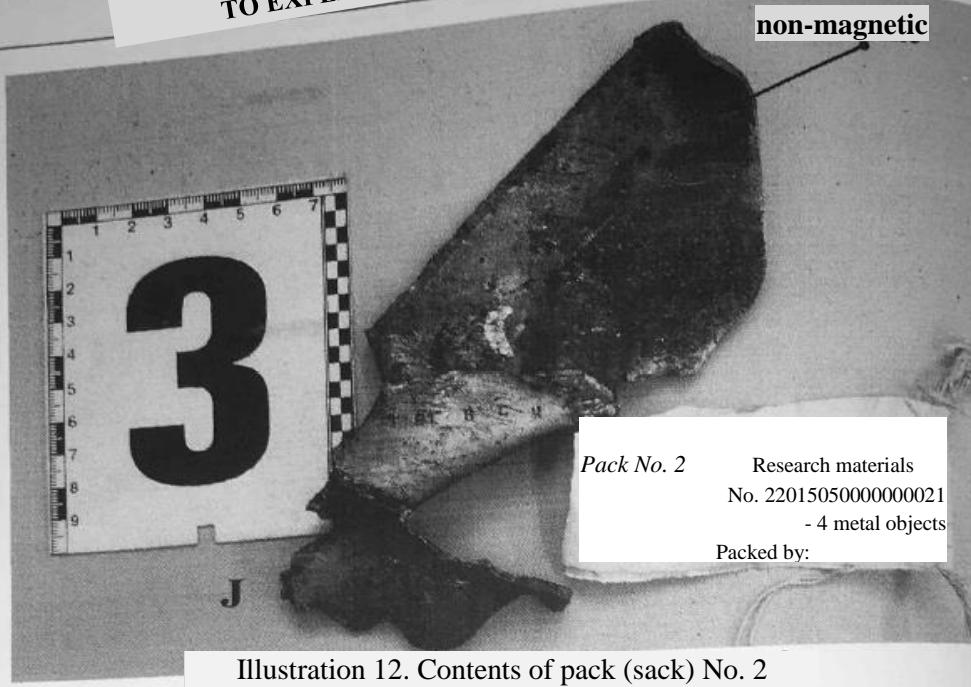

Illustration 12. Contents of pack (sack) No. 2



Illustration 13. Contents of pack (sack) No. 2

Expert:

[stamp]:
Security Service of Ukraine
For Expert Examinations #1

[signature]
O. Koshel

**SECURITY SERVICE OF UKRAINE
TABLE OF ILLUSTRATIONS
TO EXPERT OPINION No. 16/8 of 05/07/2015**

**2. Objects collected outside the epicenters of the explosions.
The numbering that was used in the research is placed on the photos of the objects.**

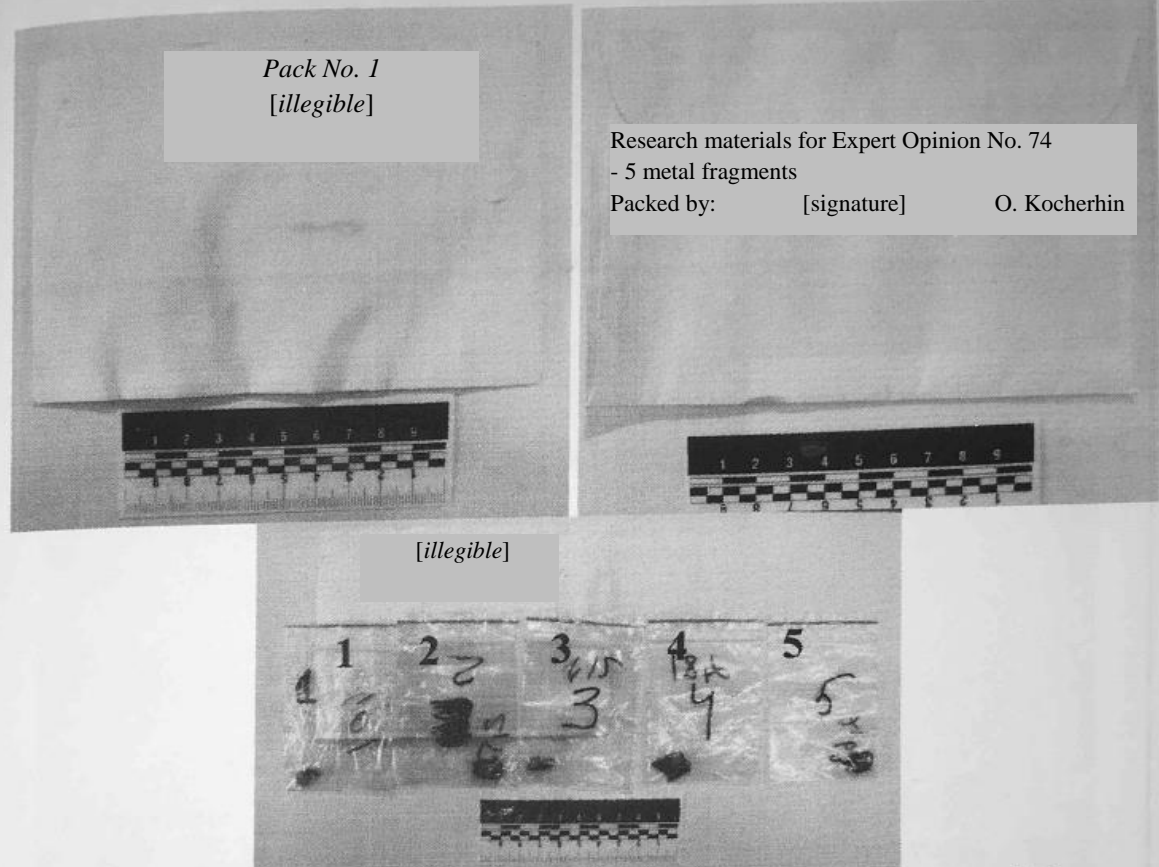

Illustration 1. External view of packaging of physical evidence and contents of pack No. 1.

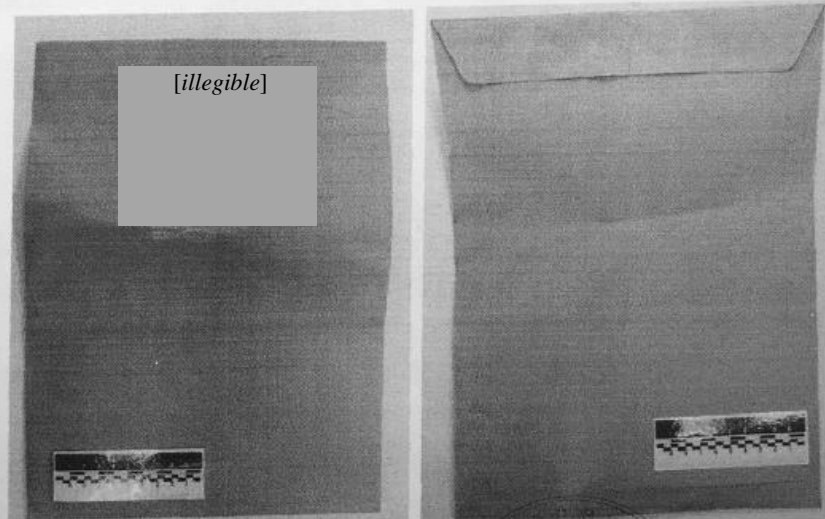

Illustration 2. External view of packaging of physical evidence and contents of pack No. 3.

Expert: [illegible] [stamp]: Security Service of Ukraine [signature] O. Koshel
For Expert Examinations #1

SECURITY SERVICE OF UKRAINE
TABLE OF ILLUSTRATIONS
TO EXPERT OPINION No. 16/8 of 05/07/2015

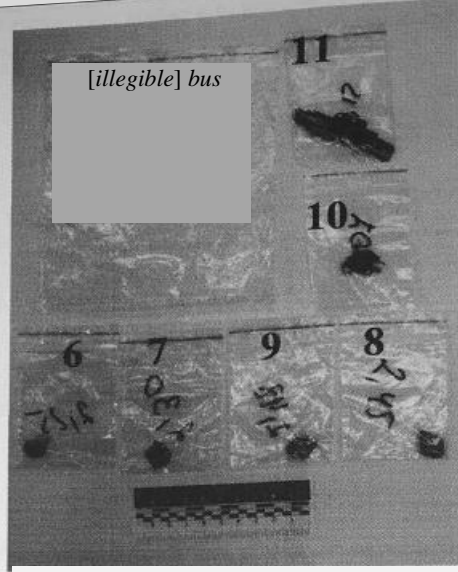

Illustration 3. Contents of pack No. 3

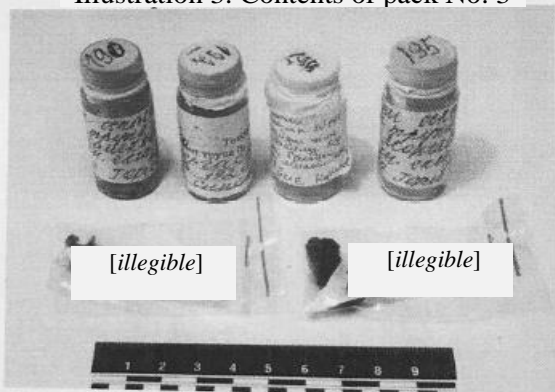

Illustration 4. External view of packaging of physical evidence

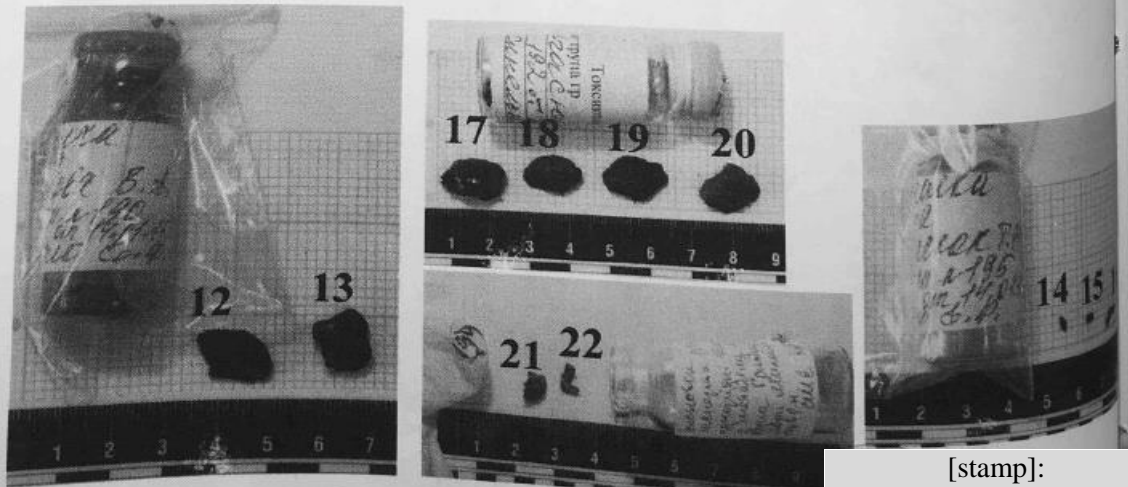

Illustration 5. Contents of glass bottles

Expert:

[stamp]:
Security Service of Ukraine
For Expert Examinations #1
[signature] O. Koshel

**SECURITY SERVICE OF UKRAINE
TABLE OF ILLUSTRATIONS
TO EXPERT OPINION No. 16/8 of 05/07/2015**



Illustration 6. Contents of two bags

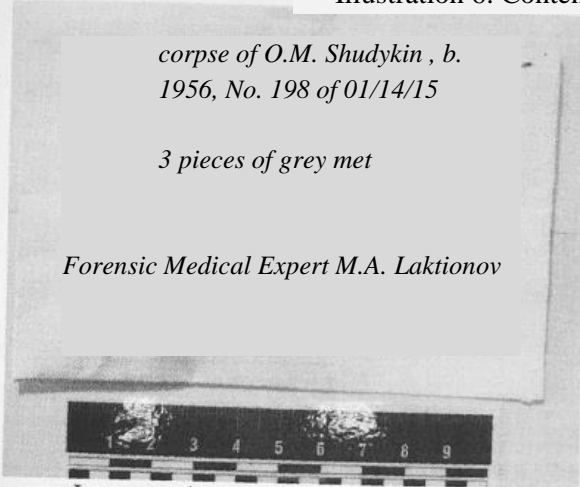

*corpse of O.M. Shudykin, b.
1956, No. 198 of 01/14/15*

3 pieces of grey met

Forensic Medical Expert M.A. Laktionov

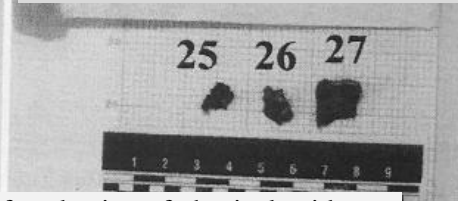

Illustration 7. External view and contents of packaging of physical evidence

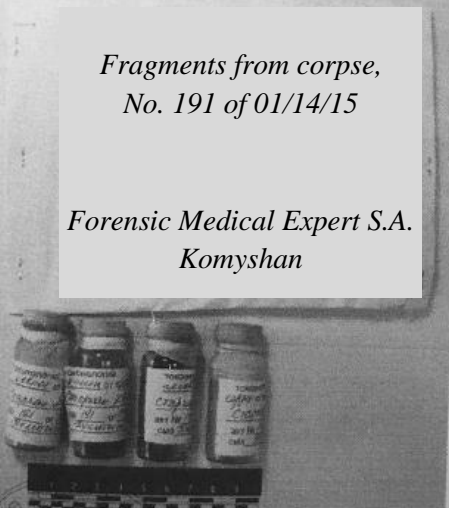
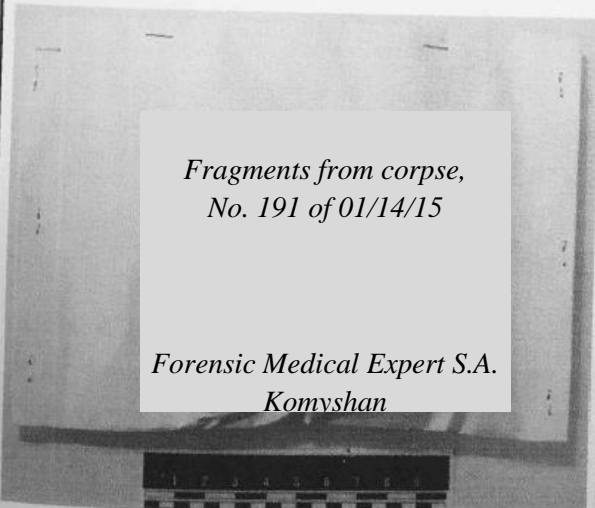
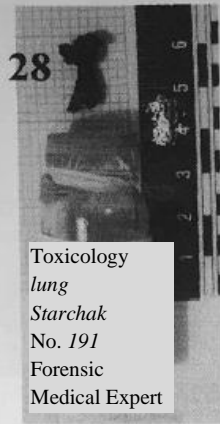

Illustration 8. External view and contents of packaging of physical evidence

Expert: [stamp]: Security Service of Ukraine For Expert Examinations #1 [signature] O. Koshel

**SECURITY SERVICE OF UKRAINE
TABLE OF ILLUSTRATIONS
TO EXPERT OPINION No. 16/8 of 05/07/2015**



Toxicology
lung
Starchak
No. 191
Forensic
Medical Expert

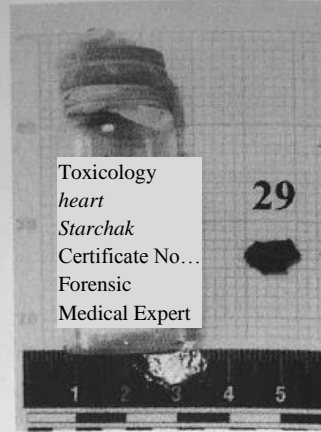

Toxicology
heart
Starchak
Certificate No...
Forensic
Medical Expert

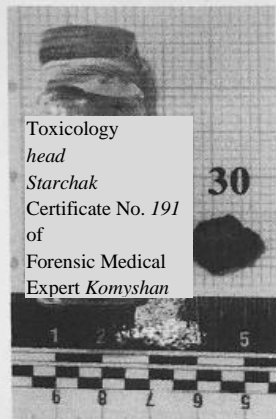

Toxicology
head
Starchak
Certificate No. 191
of
Forensic Medical
Expert *Komyshan*

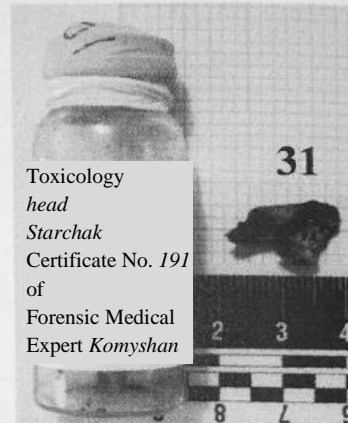

Toxicology
head
Starchak
Certificate No. 191
of
Forensic Medical
Expert *Komyshan*

Illustration 9. Contents of packaging of physical evidence

*corpse of I.O. Kornilov, b.
1984.
Four pieces of grey metal.
No. 193 dated 01/14/15.*

*Forensic Medical Expert M.A.
Laktionov*

*corpse of I.O. Kornilov, b.
1984.
Four pieces of grey metal.
No. 193 dated 01/14/15.*

*Forensic Medical Expert
M.A. Laktionov*

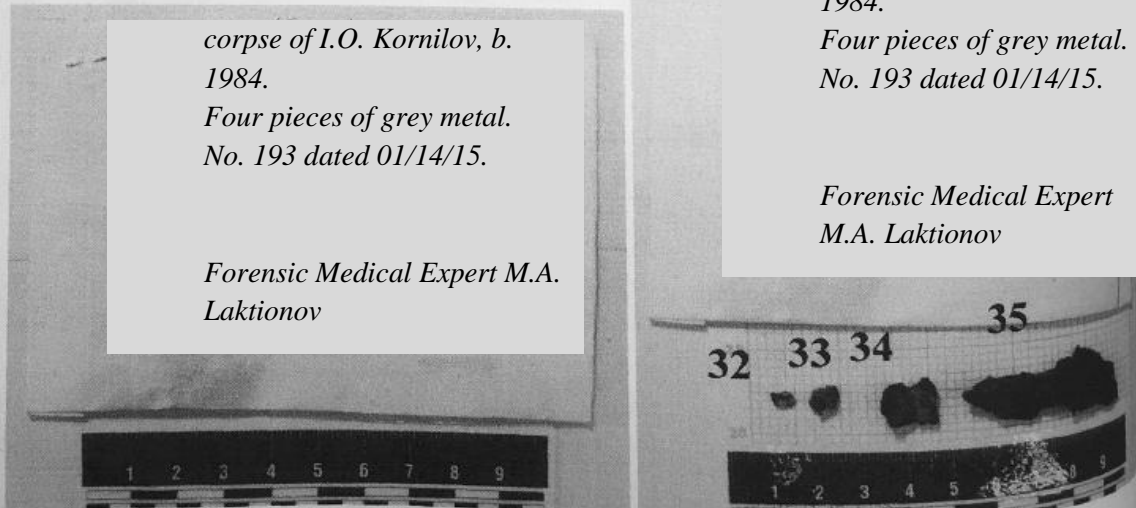

Illustration 10. External view and context of packaging of physical evidence

Expert:

[stamp]:
Security Service of Ukraine
For Expert Examinations #1

[signature] O. Koshel

SECURITY SERVICE OF UKRAINE
TABLE OF ILLUSTRATIONS
TO EXPERT OPINION No. 16/8 of 05/07/2015

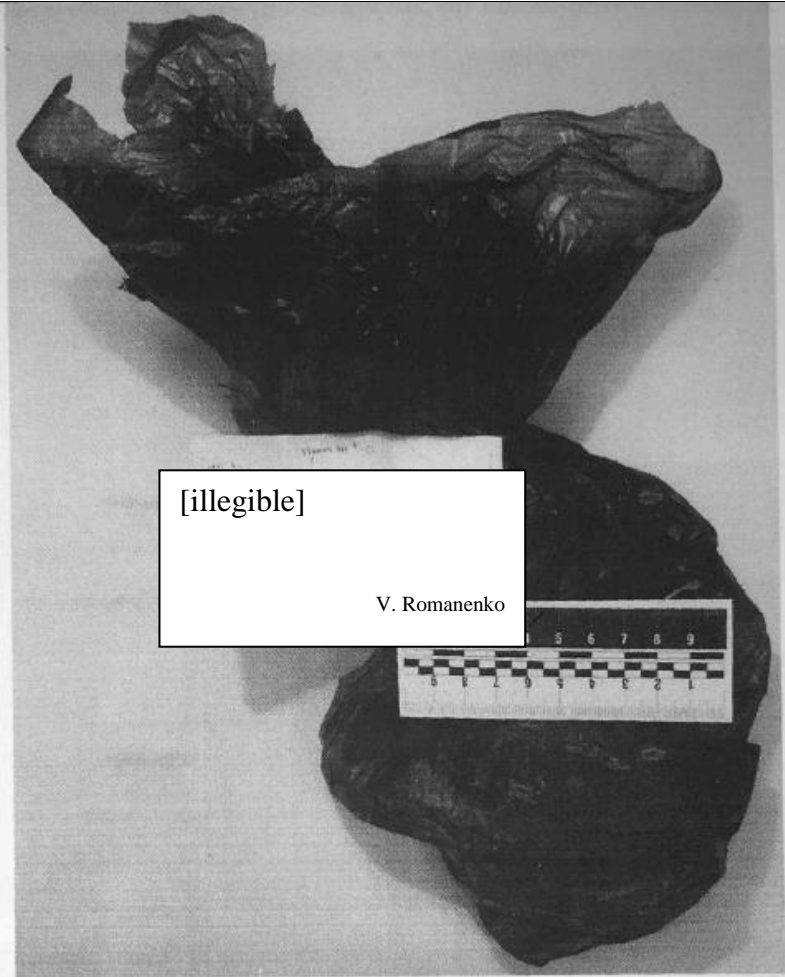

Illustration 11. External view of packaging of physical evidence

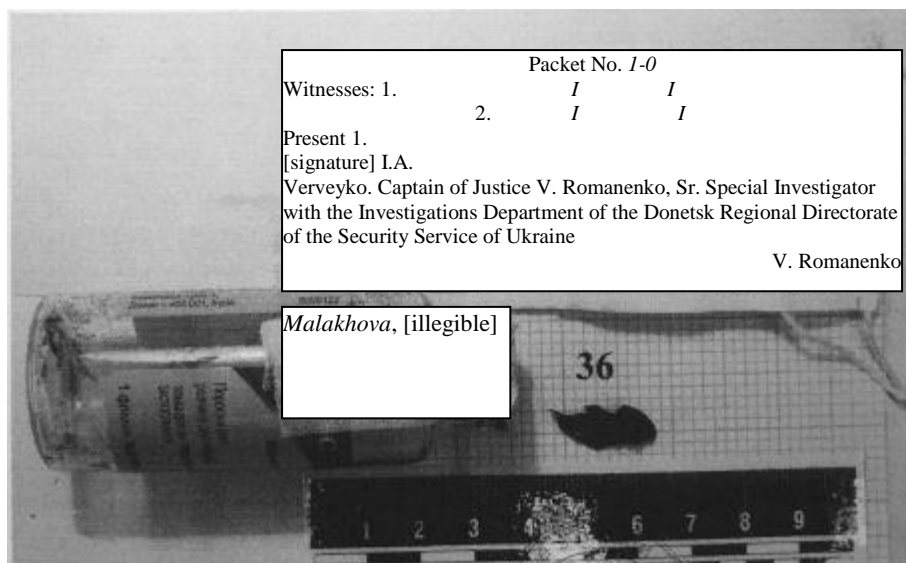

Illustration 12. Contents of pack from ill. 11

Expert:

[signature]

[stamp]:

O. Koshel

Security Service of Ukraine
For Expert Examinations #1

SECURITY SERVICE OF UKRAINE
TABLE OF ILLUSTRATIONS
TO EXPERT OPINION No. 16/8 of 05/07/2015

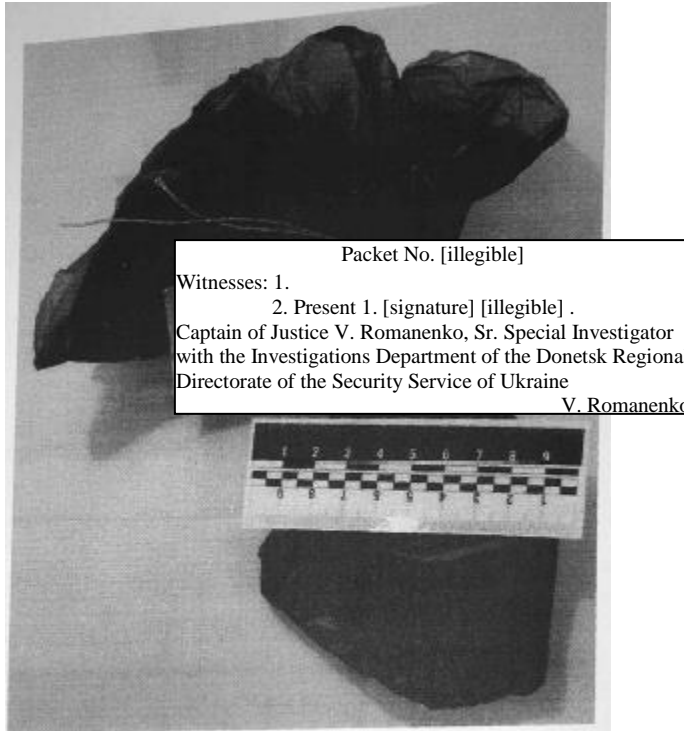

Illustration 13. External view of packaging of physical evidence

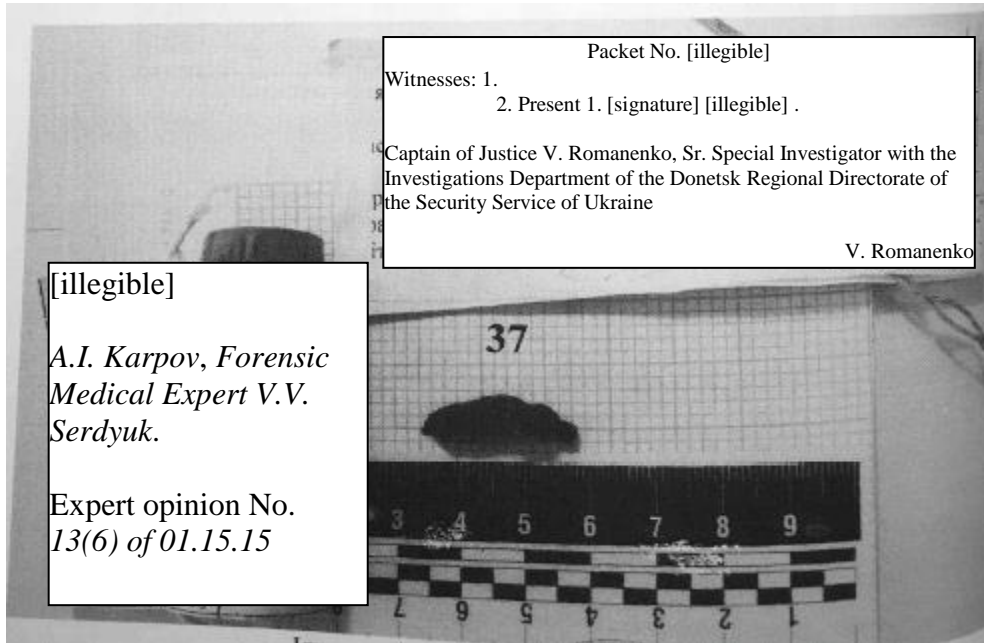

Illustration 14. Contents of pack from Illustration 13.

Expert:

[signature]

[stamp]:

O. Koshel

Security Service of Ukraine
For Expert Examinations #1

SECURITY SERVICE OF UKRAINE
TABLE OF ILLUSTRATIONS
TO EXPERT OPINION No. 16/8 of 05/07/2015

3. Traces of explosive impact

The numbering that was used in the research is placed on the photos of the objects.

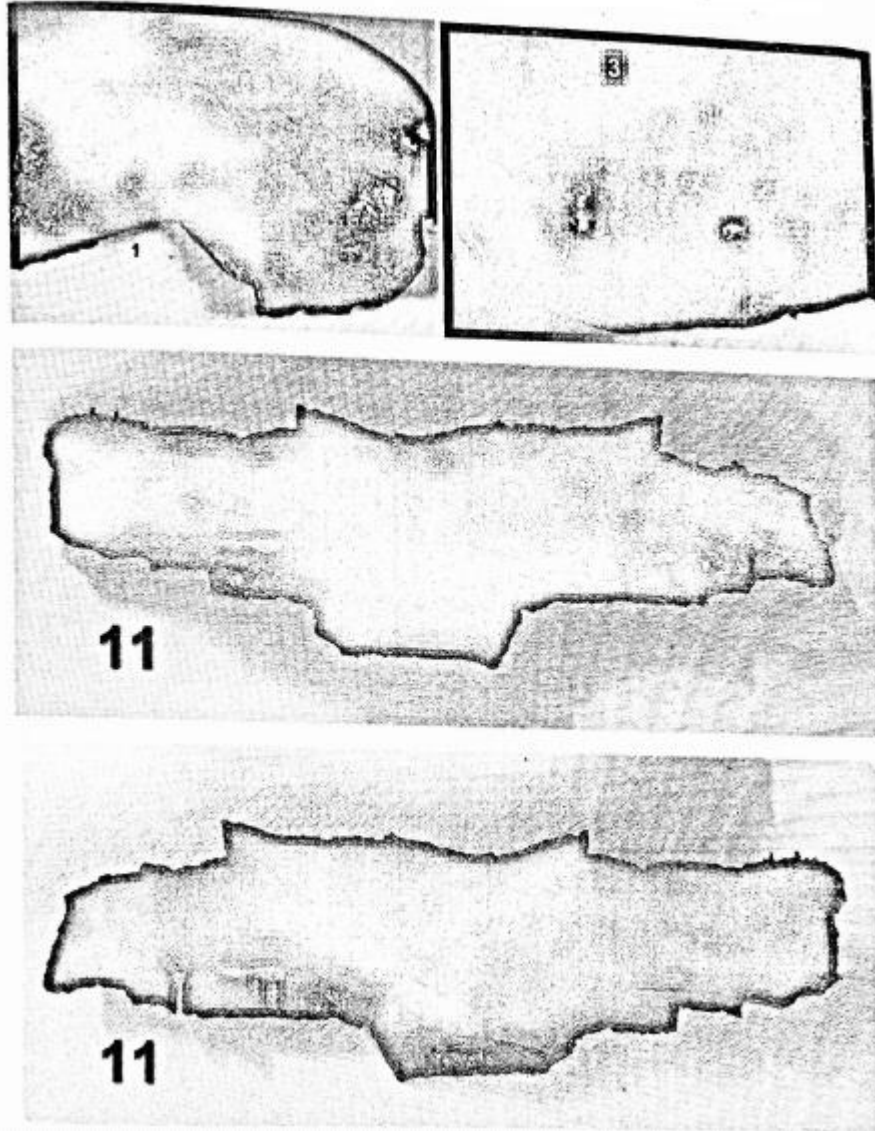

Illustration No. 1. External view of fragments

Expert:

[signature]

[stamp]:

Security Service of Ukraine
For Expert Examinations #1

O. Koshel

SECURITY SERVICE OF UKRAINE
TABLE OF ILLUSTRATIONS
TO EXPERT OPINION No. 16/8 of 05/07/2015

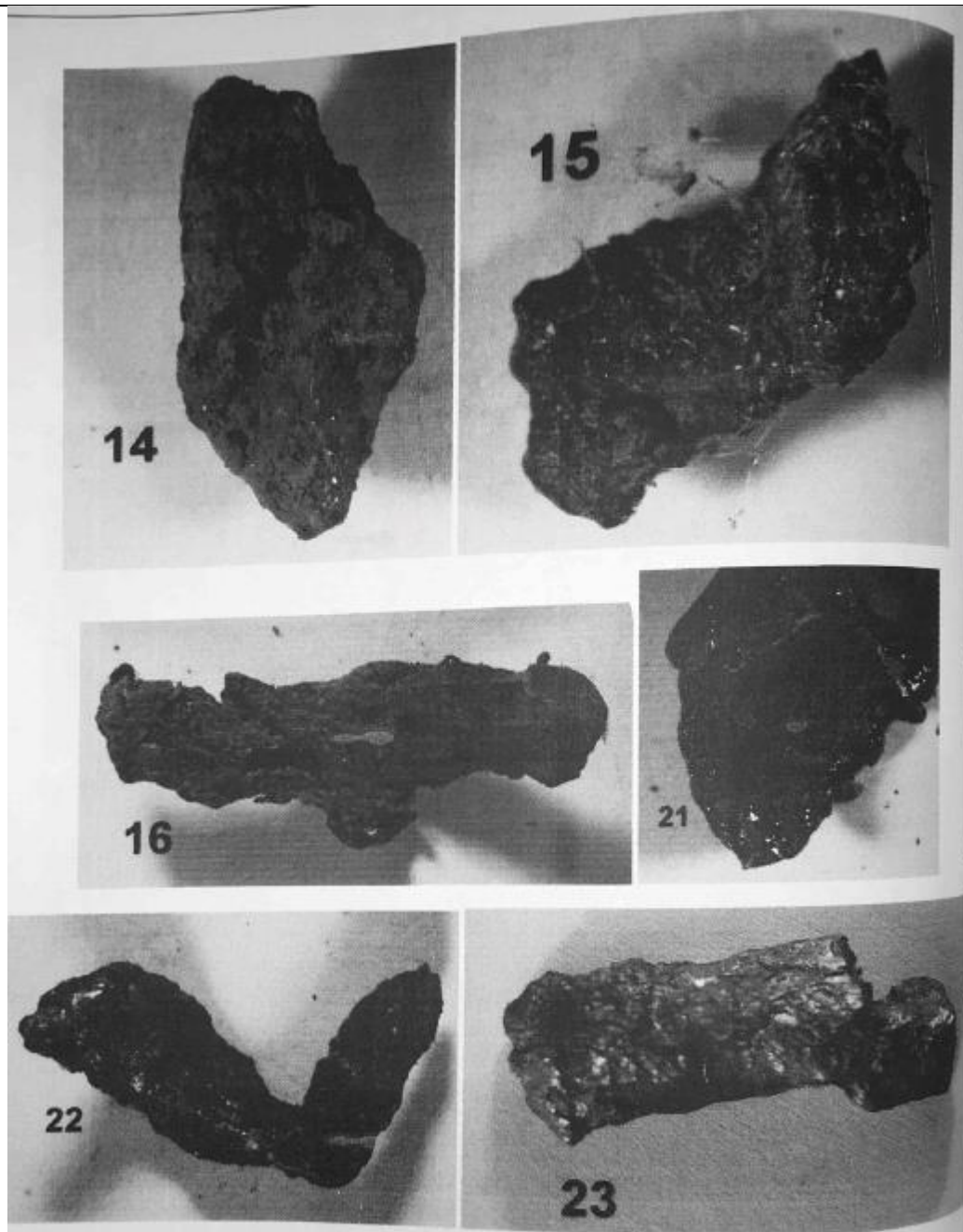

Illustration No. 2. External view of fragments

Expert:

[signature]

[stamp]:

Security Service of Ukraine
For Expert Examinations #1

O. Koshel

SECURITY SERVICE OF UKRAINE
TABLE OF ILLUSTRATIONS
TO EXPERT OPINION No. 16/8 of 05/07/2015

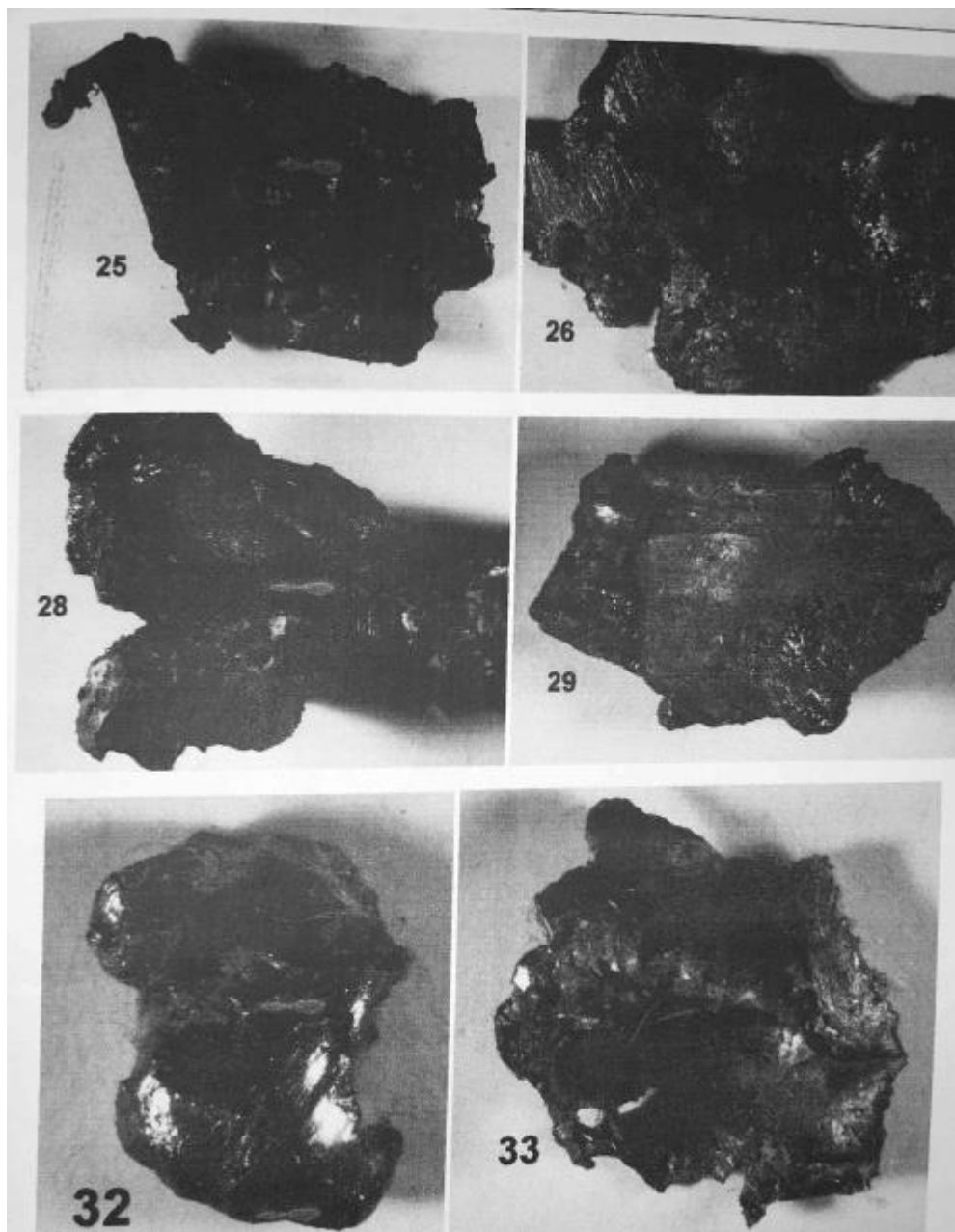

Illustration No. 3. External view of fragments

Expert:

[signature]

[stamp]:

Security Service of Ukraine
For Expert Examinations #1

O. Koshel

**SECURITY SERVICE OF UKRAINE
TABLE OF ILLUSTRATIONS
TO EXPERT OPINION No. 16/8 of 05/07/2015**

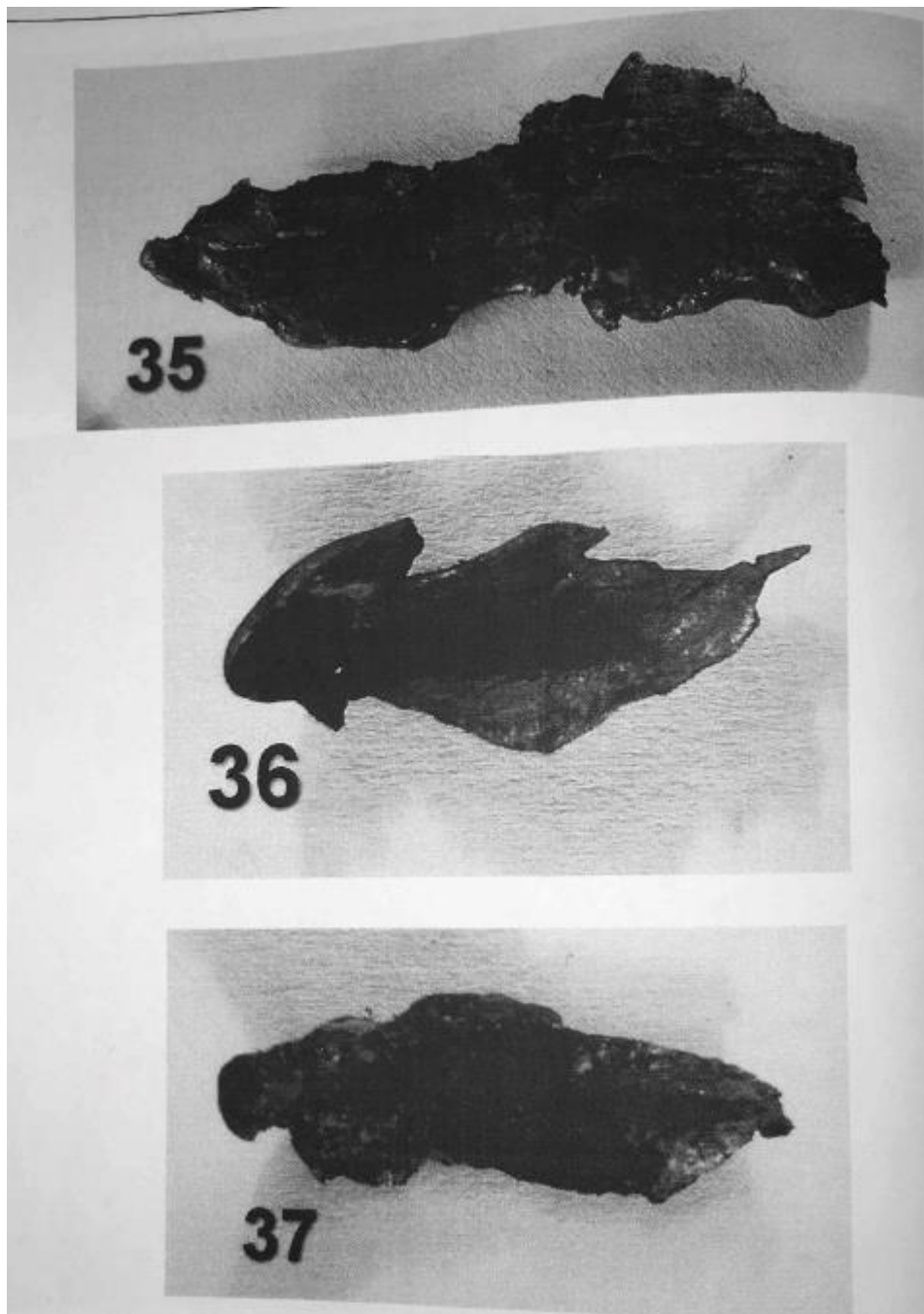

Illustration No. 4. External view of fragments

Expert:

[signature]

[stamp]:

O. Koshel

Security Service of Ukraine
For Expert Examinations #1

SECURITY SERVICE OF UKRAINE
TABLE OF ILLUSTRATIONS
TO EXPERT OPINION No. 16/8 of 05/07/2015

4. Geometric shape of metal fragments

The numbering that was used in the research is placed on the photos of the objects.

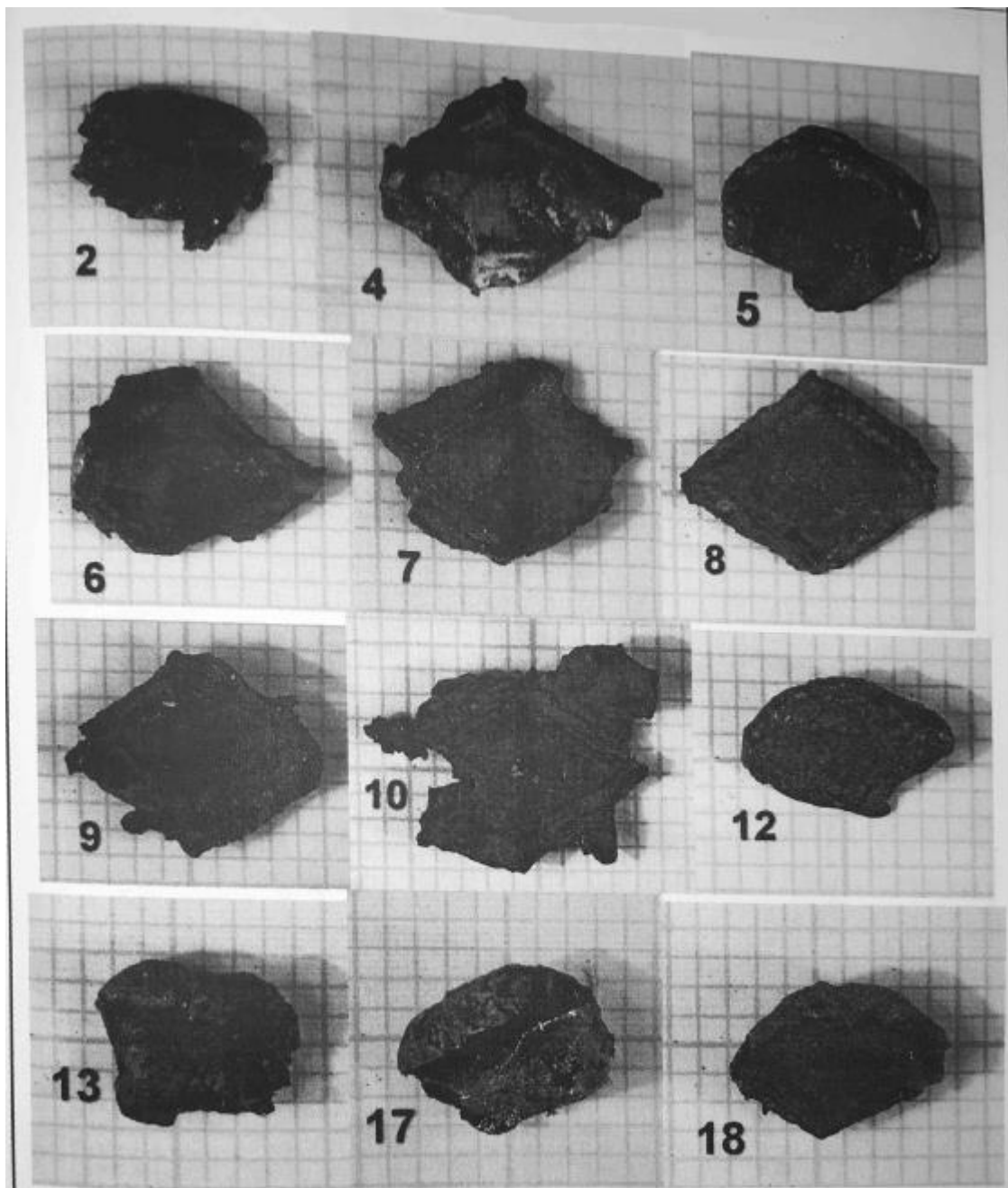

Illustration No. 1. Fragments

Expert:

[signature]

[stamp]:

Security Service of Ukraine
For Expert Examinations #1

O. Koshel

SECURITY SERVICE OF UKRAINE
TABLE OF ILLUSTRATIONS
TO EXPERT OPINION No. 16/8 of 05/07/2015

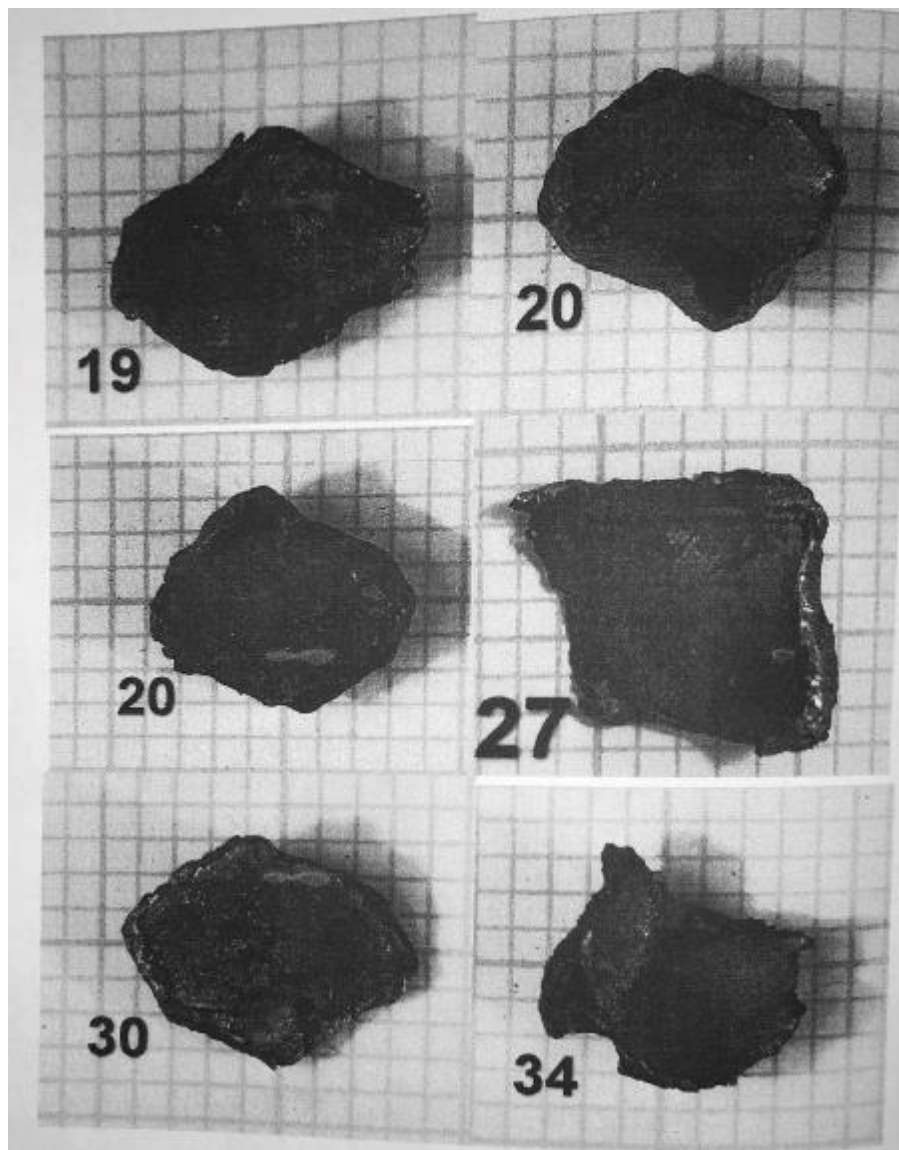

Illustration No. 2. Fragments

Expert:

[signature]

[stamp]:

Security Service of Ukraine
For Expert Examinations #1

O. Koshel

SECURITY SERVICE OF UKRAINE
TABLE OF ILLUSTRATIONS
TO EXPERT OPINION No. 16/8 of 05/07/2015

5. Examination under an electron microscope

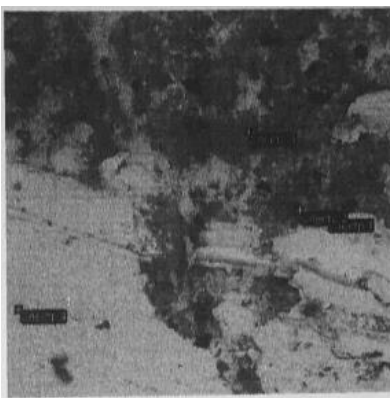

300 mkt

Electronic image 1

Treatment parameters: Analysis of all elements performed (Normalized)

Spectrum	In item	C	O	Na	Al	Si	P	S	Cl	K	Ca	Fe	Zn
Spectrum 1	Yes	48.54	27.42	3.02	3.84	0.20			5.04	1.20	4.95	5.80	
Spectrum 2	Yes	52.70	12.76	1.53	0.58	0.30		0.44	1.66	0.82	0.54	28.67	
Spectrum 3	Yes	34.88	28.50		9.07	0.26	1.09		0.49	0.72	0.79	24.19	0.00
Spectrum 4	Yes	2.95				0.32						96.73	
Max		52.70	28.50	3.02	9.07	0.32	1.09	0.44	5.04	1.20	4.95	96.73	0.00
Min		2.95	12.76	1.53	0.58	0.20	1.09	0.44	0.49	0.72	0.54	5.80	0.00

All results as weight %

Illustration 1. Object No. 1

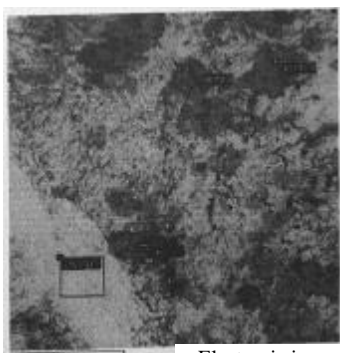

200 mkt

Electronic image 1

Treatment parameters: Analysis of all elements performed (Normalized)

Spectrum	In item	C	O	Na	Mg	Al	Si	P	Cl	K	Ca	Ti	Fe
Spectrum 1	Yes												96.89
Spectrum 2	Yes	3.11				3.07	1.77	0.52	0.72	0.56	1.22	1.46	15.85
Spectrum 3	Yes	49.36	23.95	0.92	0.59		0.76	0.28	0.79	0.66	0.77	0.57	27.12
Spectrum 4	Yes	39.04	28.79	1.21			0.26		0.94	0.53			30.57
		39.43	27.21	1.06									
Max		49.36	28.79	1.21	0.59	3.07	1.77	0.52	0.94	0.66	1.22	1.46	96.89
Min		3.11	23.95	0.92	0.59	3.07	0.26	0.28	0.72	0.53	0.77	0.57	15.85

All results as weight %

Illustration No. 2. Object No. 4

Expert:

[signature]

[stamp]:

O. Koshel

Security Service of Ukraine
 For Expert Examinations #1

SECURITY SERVICE OF UKRAINE
TABLE OF ILLUSTRATIONS
TO EXPERT OPINION No. 16/8 of 05/07/2015

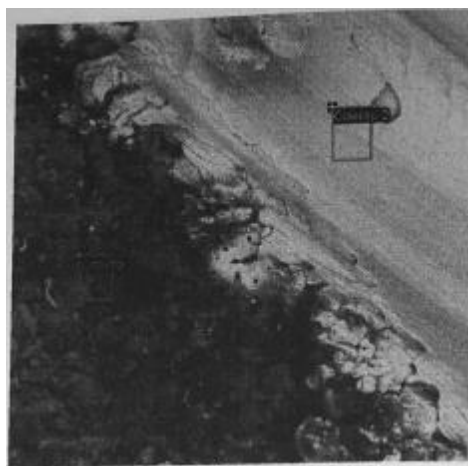

200 mkt

Electronic image 1

Treatment parameters: Analysis of all elements performed (Normalized)

Spectrum	In item	C	O	Na	Al	P	S	Ca	Fe	Total
Spectrum 1	Yes	37.85	24.69	0.59	0.47	2.40	0.44	1.78	31.79	100.00
Spectrum 2	Yes	1.13							98.87	100.00
Max		37.85	24.69	0.59	0.47	2.40	0.44	1.78	98.87	
Min		1.13	24.69	0.59	0.47	2.40	0.44	1.78	31.79	

All results as weight %

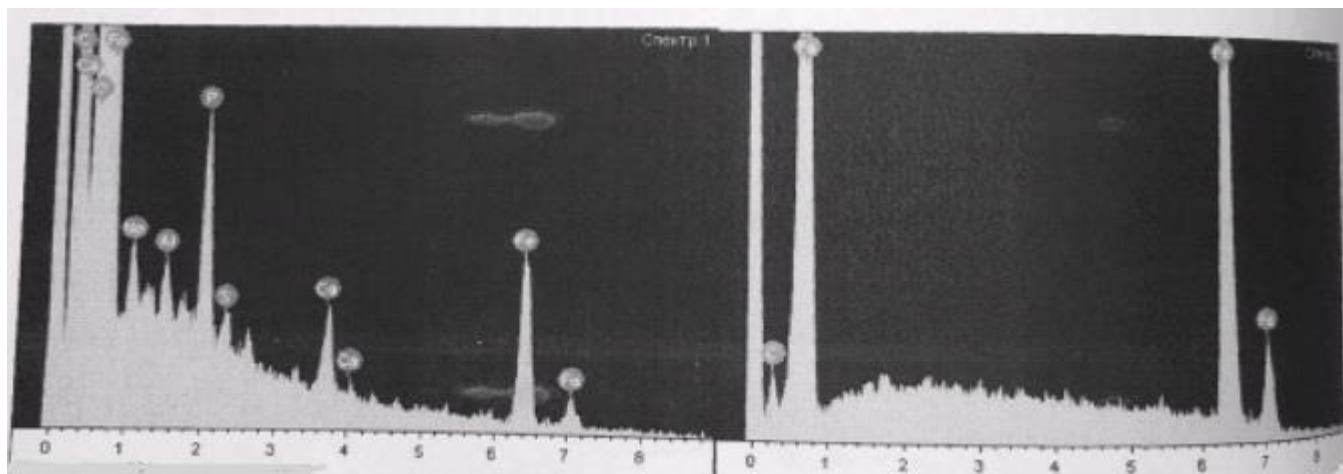

Full scale 321 imp. Cursor: 0.000

keV

Full scale 321 imp. Cursor: 5.008 (25 imp.)

keV

Illustration No. 3. Object No. 20

Expert:

[signature]

[stamp]:

O. Koshel

Security Service of Ukraine
 For Expert Examinations #1

SECURITY SERVICE OF UKRAINE
TABLE OF ILLUSTRATIONS
TO EXPERT OPINION No. 16/8 of 05/07/2015

6. Metallographic examinations

Magnification x200

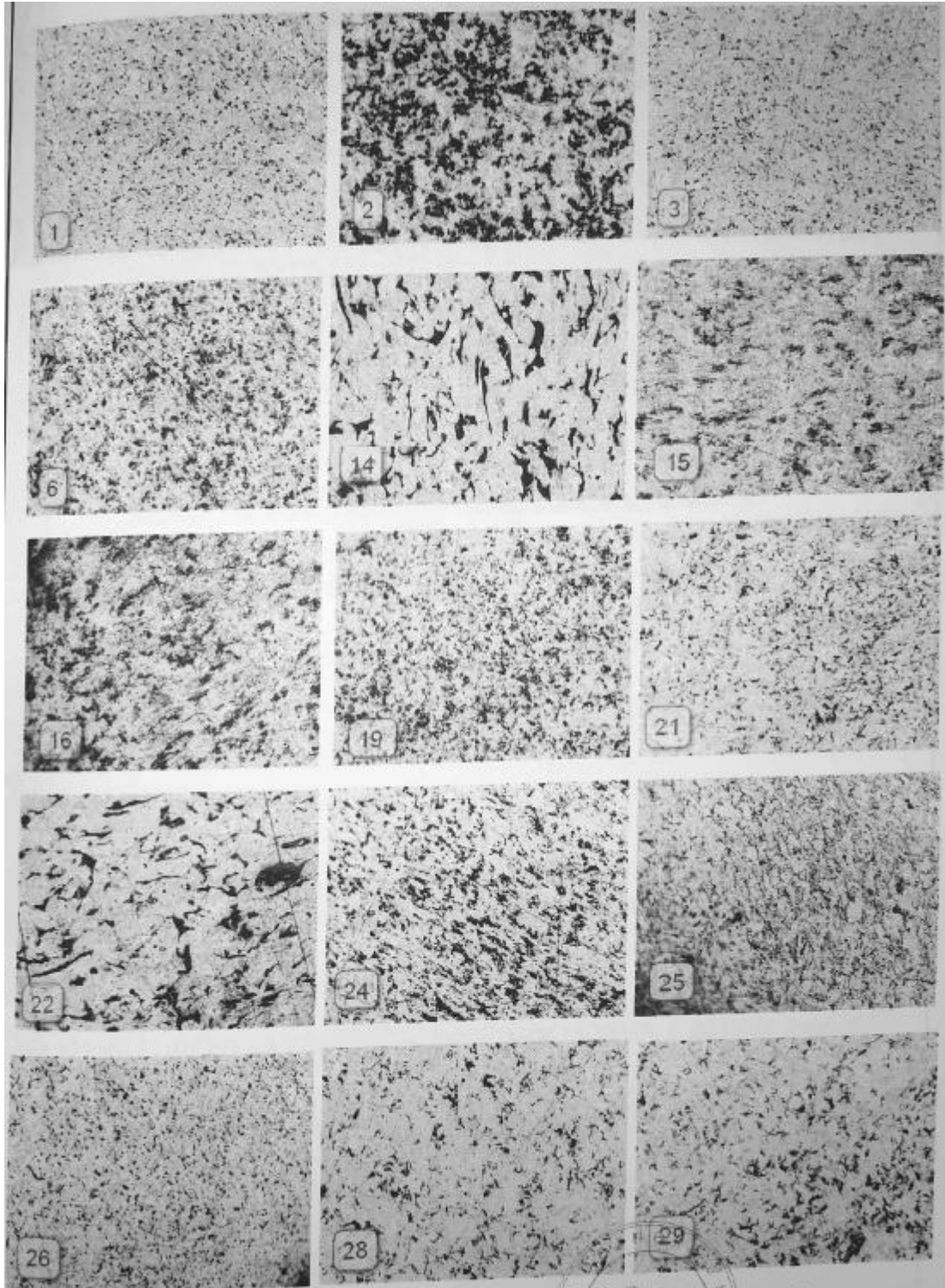

Expert:

[signature]

[stamp]:

O. Koshel

Security Service of Ukraine
For Expert Examinations #1

SECURITY SERVICE OF UKRAINE
TABLE OF ILLUSTRATIONS
TO EXPERT OPINION No. 16/8 of 05/07/2015

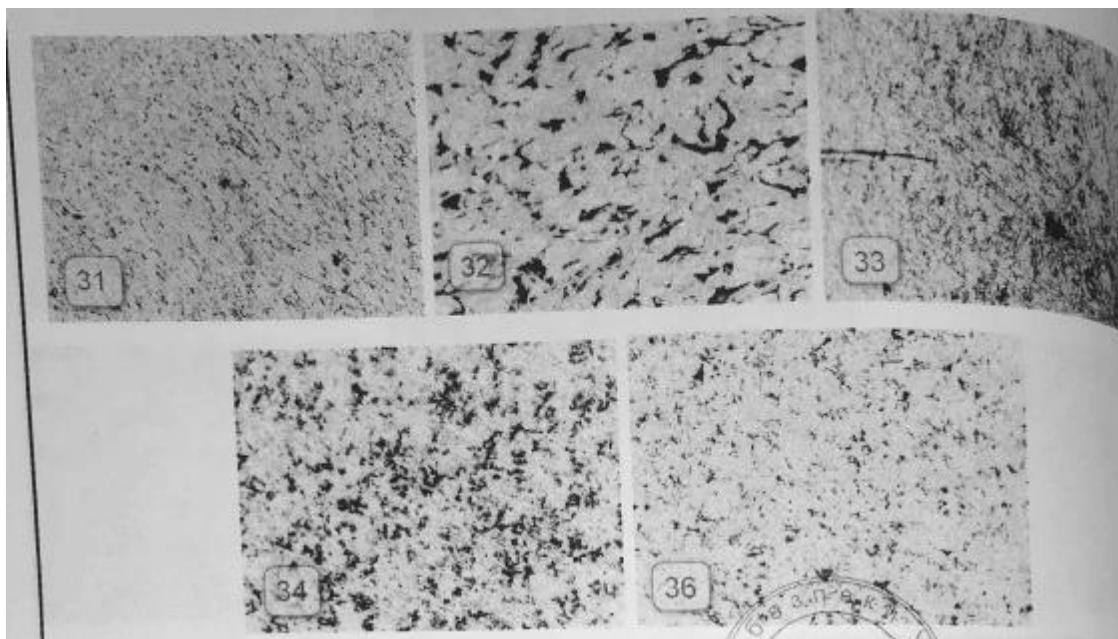

Expert:

[signature]

[stamp]:
Security Service of Ukraine
For Expert Examinations #1

O. Koshel

Annex 124

Administrative Directorate of the General Staff of the Armed Forces of Ukraine
Letter No. 300/1/C/2430 (9 May 2015)

This document has been translated from its original language into English, an official language of the Court, pursuant to Rules of the Court, Article 51.

Pursuant to Rules of the Court Article 51(3), Ukraine has translated only an extract of the original document constituting this Annex. In further compliance with this Rule, Ukraine has provided two certified copies of the full original-language document



MINISTRY OF DEFENSE OF UKRAINE
GENERAL STAFF OF THE ARMED FORCES OF
UKRAINE

6 Povitroflotsky Prospect, Kyiv, 03168. Phone: (044) 226-26-56. Fax: (044) 226-26-56

Email: kabmin_doc@mil.gov.ua

Code in the Uniform Register of Businesses and Organizations of Ukraine: 22991050

_____ No. _____

Foreign Ministry of Ukraine

In pursuance of Instruction No. 02-01/2948 of October 15, 2014 issued by the Ukrainian Presidential Chief of Staff, presented herewith are informational reference materials pertaining to the body of evidence for the presence of foreign military groups in Ukrainian territory, to be used in raising the awareness of Ukrainian society and international partners more actively and in the future lawsuits to be filed by Ukraine with the relevant international courts.

Attachment: above-mentioned information on 1 page, unclassified, for the specified recipient only

Acting First Deputy Chief
of the General Staff of the Armed Forces of Ukraine

Major General

[Signature]

V.M. NAZAROV

FOREIGN MINISTRY OF UKRAINE
DEPARTMENT OF THE GENERAL SECRETARIAT
Incoming Ref. No. 41501
May 15, 2015

Administrative Directorate of the General Staff of the Armed
Forces of Ukraine

No. 300/1/C/2430 of May 9, 2015

4:26:02 pm Pages: 1/1

V.A. Khomenko, 454-40-78



000340*

Order 50-2015

INFORMATIONAL REFERENCE MATERIALS

pertaining to the body of evidence for the direct invasion by foreign military groups into Ukrainian territory

I. Regarding the involvement of Russian citizens in illegal paramilitary groups operating in Eastern Ukraine

No documented facts of the involvement of Russian citizens in illegal paramilitary groups operating in Eastern Ukraine were recorded last week.

II. Regarding the chronology of the crossing of the state border of Ukraine by personnel, weapons, and military vehicles of the Armed Forces of the Russian Federation

No.	Date	Border crossing point crossed	Point of destination (crossing)	Number of convoys	Number of vehicles (personnel)
1.	May 05	LUHANSK	IZVARYNE		57 tarpaulin trucks
2.	May 05	IZVARYNE	LUHANSK		7 MTLB light-armored multipurpose tracked towing vehicles and 8 tarpaulin trucks
3.	May 5	Chervonopartyzansk	SVERDLOVSK	1	14 tanks, BMP infantry fighting vehicles, 7 trucks, 100 militants
4.	May 5	IZVARYNE	LUHANSK	1	Buk guided ground-to-air missile system, four trucks
5.	May 5	LUHANSK	IZVARYNE	1	24 trucks
6.	May 3	KRASNODON	LUHANSK		30 BTR armored personnel carriers, 12 BMP infantry fighting vehicles, 10 KamAZ trucks from the PMP warehouse, and 30 ATT heavy artillery tractors with ammunition
7.	May 3	IZVARYNE	LUHANSK		7 semi-trailer trucks
8.	May 2	Chervonopartyzansk	SVERDLOVSK	1	Up to 5 tanks, up to 2 BTR armored personnel carriers, up to 7 KamAZ heavy artillery tractors with personnel (up to 300 militants; their affiliation to be updated)
9.	May 1	USPENKA border crossing point	Through the towns of ZUHRES and KHARTSYZK in the direction of Donetsk	2	23 tanks, 4 MTLB light-armored multipurpose tracked towing vehicles, 4 Ural trucks
10.	April 30	IZVARYNE	LUHANSK		10 tarpaulin trucks and 4 GRAD BM-21 multiple rocket launchers, 3 semi-trailer trucks, 4 tarpaulin vans, and 4 unidentified vehicles (type to be updated), up to 15 BMP-1 (or BMD-1) infantry fighting vehicles, and 1 tank (type to be updated)

Chief of the Main Command Center
of the Armed Forces of Ukraine

Lieutenant General

[Signature]

S.M. POPKO

Annex 125

Administrative Directorate of the General Staff of the Armed Forces of Ukraine
Letter No. 300/1/C/2539 (15 May 2015)

This document has been translated from its original language into English, an official language of the Court, pursuant to Rules of the Court, Article 51.

Pursuant to Rules of the Court Article 51(3), Ukraine has translated only an extract of the original document constituting this Annex. In further compliance with this Rule, Ukraine has provided two certified copies of the full original-language document



GENERAL STAFF OF THE ARMED FORCES OF UKRAINE

6 Povitroflotsky Prospect, Kyiv-168, Ukraine
Phone: (044) 234-01-92. Fax: (044) 226-26-56

_____ No. _____
Re: No. _____

Foreign Ministry of Ukraine

In pursuance of Instruction No. 02-01/2948 of October 15, 2014 issued by the Ukrainian Presidential Chief of Staff, presented herewith are informational reference materials pertaining to the body of evidence for the presence of foreign military groups in Ukrainian territory, to be used in raising the awareness of Ukrainian society and international partners more actively and in the future lawsuits to be filed by Ukraine with the relevant international courts.

Attachment: above-mentioned information on 1 page, unclassified, for the specified recipient only.

Acting First Deputy Chief
of the General Staff of the Armed Forces of Ukraine

Major General

[Signature]

V.M. NAZAROV

R.O. Tarasenko, 454-40-78

FOREIGN MINISTRY OF UKRAINE
DEPARTMENT OF THE GENERAL SECRETARIAT
Incoming Ref. No. 43780
May 22, 2015

000412*

Administrative Directorate of the General Staff of the Armed
Forces of Ukraine

No. 300/1/C/2539 of May 15, 2015

9:08:38 am Pages: 1/1



Order 258-2008

INFORMATIONAL REFERENCE MATERIALS
pertaining to the body of evidence for the direct invasion by foreign military groups into
Ukrainian territory

I. Regarding the involvement of Russian citizens in illegal paramilitary groups operating in Eastern Ukraine

No documented facts of the involvement of Russian citizens in illegal paramilitary groups operating in Eastern Ukraine were recorded last week.

II. Regarding the chronology of the crossing of the state border of Ukraine by personnel, weapons, and military vehicles of the Armed Forces of the Russian Federation

No.	Date	Border crossing point crossed	Point of destination (crossing)	Number of convoys	Number of vehicles (personnel)
	May 11	DOLZHANSKYI	LUHANSK	1	9 tanks
	May 8	LUHANSK	IZVARYNE		a truck and a tanker truck;
		IZVARYNE	LUHANSK		17 trucks (including 7 semi-trailers) and a tanker truck.
		IZVARYNE	DONETSK		18 trucks with trailers (arrived at warehouses at 7 Chernihivska Street; cargo information to be updated).

Chief of the Main Command Center
of the Armed Forces of Ukraine

Lieutenant General

[Signature]

S.M. POPKO

Annex 126

Expert Opinion No. 38/6, Ukrainian Research Center for Special-Purpose
Equipment and Forensic Examinations of the Security Service of Ukraine (18 May
2015)

This document has been translated from its original language into English, an official
language of the Court, pursuant to Rules of the Court, Article 51.

Pursuant to Rules of the Court Article 51(3), Ukraine has translated only
an extract of the original document constituting this Annex. In further
compliance with this Rule, Ukraine has provided two certified copies of the
full original-language document



SECURITY SERVICE OF UKRAINE
**Ukrainian Scientific Research Institute for Special Equipment
 and Forensic Expert Examinations**
EXPERT OPINION

05/18/2015

City of Kyiv

No. 38/6

Copy No. 1

I, Vitaly Petrovych Stasyuk, an expert consultant with Section 6 of the 4th Center (Center for Forensic and Special Expert Examinations) of the Ukrainian Scientific Research Institute for Special Equipment and Forensic Expert Examinations of the Security Service of Ukraine, with an advanced technical degree, special expert training and experience working as an expert since 2012, holding the qualification of a forensic expert with the right to conduct explosives research with specializations in “Researching Explosive Devices and the Traces and Circumstances of Explosions” (registration certificate No. 477 issued by the Expert Qualification Commission of the Security Service of Ukraine on 03/13/2012) and “Forecasting the Possible Effects of the Use of Explosive Devices and the Traces and Circumstances of Explosions” (registration certificate No. 478 issued by the Expert Qualification Commission of the Security Service of Ukraine on 03/13/2012), pursuant to an order calling for an expert explosives examination, issued by Colonel of Justice Ye.L. Kosyak, Deputy Head of the Investigations Department of the Donetsk Regional Directorate of the Security Service of Ukraine, conducted an expert explosives examination based on the files of criminal proceeding No. 22015050000000021.

I am aware of the facts of the case from the investigator’s order calling for an expert examination.

Together with cover letter No. 56/21-621 nt of 03/04/2015, the Donetsk Regional Directorate of the Security Service of Ukraine provided for expert examination 5 transparent packages with fasteners, bound with black thread and sealed with paper glue, containing an explanatory note and the signatures of the investigator and those present.

The expert has been warned of potential liability for presenting knowingly false findings and refusing without a valid excuse to perform his duties under Articles 384 and 385 of the Criminal Code of Ukraine:

[stamp] [signature] Security Service of Ukraine, For expert examinations, No. 1

The expert was asked to answer the following questions:

- what kind of damage was found on the Zlatoustivka-Donetsk TATA A07A bus with number plate AN 0985, which was submitted for examination?
- what was the mechanism of formation of the damage found on the Zlatoustivka-Donetsk TATA A07A bus with number plate AN 0985, which was submitted for examination?
- what were the relative positions of the bus and the source that generated the destructive agents responsible for causing the damage found on the bus, and the distance between the bus and the source that generated the destructive agents?

- what caused the formation of the destructive agents found during the examination of the bus, the impact of which caused the damage found during the examination of the bus?
- was the mechanical damage to the bus submitted for expert examination caused by one or multiple factors responsible for the formation of the destructive agents?
- did the mechanical damage to the bus submitted for expert examination occur instantaneously or in several stages; in the latter case, how many such stages were there in the formation of the destructive agents, the impact of which caused the mechanical damage to the bus submitted for expert examination?
- what was the mechanism of origin of the destructive agents found during the examination of the bus, what type or sort of munitions (explosive devices) were they components of, were they formed from the blast of one type or multiple types of munitions (explosive devices), were they formed instantaneously or over a certain period of time, and if the latter, over what period exactly?
- could the damage to the bus found during the examination and the fragments removed from the passenger section of the bus have been formed by the explosion of a stationary landmine or from gunfire directed at the bus?

The following information sources were used in conducting the research:

- *Methods of Complex Analysis of Explosive Devices, Explosive Substances and Traces of Explosions* (H.V. Prokhorov-Lukin, V.I. Pashchenko, V.I. Bykov, et al – Kyiv: Elite Print LLC, 2011, p. 216: il.);
- *Mass-Produced Explosive Devices and the Criminalistic Analysis Thereof* (Yu.M. Dildin, V.V. Martynov, Expert Criminalistics Center of the Ministry of Internal Affairs of the Russian Federation. Moscow. 1991);
- *Explosives Expert Book: a Study Guide and Methodological Handbook* (Moscow 2001);
- *Explosives Expert Book: a Study Guide and Methodological Handbook* (Moscow 1991);
- Information from the Internet, particularly the website of Splav Research & Production Association OJSC;
- “Tables of Fire from M-21-OF High-Explosive Fragmentation Rocket-Propelled Shells (Ministry of Defense of the USSR, Moscow 1975);
- “BM-21 Combat Vehicle: Technical Description and Operating Instructions,” Ministry of Defense of the USSR, Moscow 1972;
- *Accidents and Catastrophes. Prevention and Clean-up. A Textbook in 3 Volumes*. V.A. Kotlyarevsky, A.V. Vinogradov, S.V. Eremin, et al.—Moscow: ASV Publishing House, 1996;
- *Explosion Hazards and Evaluation: in 2 volumes*. Translated from English/W. Baker, P. Cox, P. Westine, et. al.; Edited by Ya.B. Zaldovich and B.Ye. Gelfand—Moscow: Milner, 1986;
- Pokrovsky, G.I. *Explosions. 4th Edition*. Moscow—Nedra, 1980;
- Salamakhin, T.M. *Physical Principles of the Mechanical Impact of an Explosion and Methods of Calculating Explosive Loads*. Military Engineering Academy Publishing House, Moscow, 1974;

- Salamakhin, T.M. *Destruction of Structural Elements by Explosions (a Textbook)*. Military Engineering Academy Publishing House, Moscow, 1961;
- Epov, B.A. *Principles of Explosives*. Moscow: Voenizdat, 1974;
- Order No. 700 of the Ministry of Defense of Ukraine dated 12/27/2010, Kyiv

The following were used in conducting the research:

- caliper ShTs-1 GOST 166-89;
- metal ruler GOST 427-75;
- magnifying glass with 4x magnification;
- OLYMPUS x-775 camera;
- map marking stencil;
- protractor;
- engineering calculator;
- SATORIUS electronic scales.

The air temperature in the room was +20°C.

RESEARCH

The objects submitted for examination were packed in accordance with the criminalistic procedure rules for the storage and transportation of physical evidence. The packing precludes access to the contents and is undamaged (*illustrations Nos. 1-3, 6-7 and 10*).

Upon being opened, the packs were found to contain metal fragments of various shapes (*illustrations Nos. 4, 5, 8, 9 and 11*);

- object No. 1, illustration No. 4, metal fragment of irregular shape measuring 13 x 1.2 x 8 mm and weighing 0.55 g.
- object No. 2, illustration No. 5, metal fragment of irregular shape measuring 15 x 1.6 x 11 mm and weighing 2.03 g.
- object No. 3, illustration No. 8, metal fragment of irregular shape measuring 14 x 1.1 x 6 mm and weighing 0.67 g.
- object No. 4, illustration No. 9, metal fragment in the shape of a rhombus measuring 15 x 1.6 x 20 mm and weighing 2.33 g.
- object No. 5, illustration No. 11, metal fragment of irregular shape measuring 13 x 1.6 x 14 mm and weighing 2.15 g.

All of the metal fragments (objects 1-5) submitted for examination are composed of gray magnetic metal and show signs of deformation. Traces of thermal influence can be seen on the objects in the form of chaotically-spaced cavities of irregular shape with fire-damaged edges and black stratification (which appears to be soot).

According to information obtained from the Internet, specifically <http://www.splav.org/ru/arms/grad/m22u.asp>, an M-21OF 122 mm unguided high-explosive fragmentation shell (9M22U) forms 1,640 pre-formed fragments (weighing 2.4 g) and 2,280 fragments from the shell body (with an average weight of 2.9 g). In total, we obtain 3,920 fragments weighing 2.4–2.9 g.

In order to answer the questions that were posed, a comparative analysis was conducted of objects 2, 4, and 5 with the same parameters as those specified in the technical standard documentation. The results of this analysis are shown in Table No. 1

Comparative Table No. 1

Indicators of main components	Comparable item	Analyzed object
	pre-formed fragmentation element of unguided M-21 OF rocket-propelled high-explosive fragmentation shell	Shrapnel-like elements (objects Nos. 1-5)
Material of construction	gray metal	gray metal
Weight (g)	2.4	2.15-2.33 (objects Nos. 2, 4 and 5)
Geometric shape	rhombus	rhombus

The comparative analysis established that in terms of outward appearance, material of construction and structural features, the objects submitted for examination (Nos. 2, 4, and 5) are standard (pre-formed) fragmentation elements of a 122-mm unguided M-21 OF rocket-propelled high-explosive fragmentation shell (item 9M22U).

Objects Nos. 1 and 3 are also fragmentation elements of a 122-mm unguided M-21 OF rocket-propelled high-explosive fragmentation shell (item 9M22U), but it is impossible to determine what type, as they were subjected to the thermal influence of the explosion (combustion) and deformation when passing through the right side panel of the bus.

Objects Nos. 1-5 were formed as a result of the explosion of a 122-mm unguided M-21 OF rocket-propelled high-explosive fragmentation shell (item 9M22U).

Objects Nos. 2, 4, and 5 are pre-formed fragments of the fragmentation jacket of a 122-mm unguided M-21 OF rocket-propelled high-explosive fragmentation shell (item 9M22U).

Objects Nos. 1-5 are fragments of the fragmentation jacket of a 122-mm unguided M-21 OF rocket-propelled high-explosive fragmentation shell (item 9M22U).

In order to answer the question of whether the destructive agents (fragments) submitted for examination were formed from a single or multiple forms of munitions, a comparative analysis was done with engineer munitions.

MON-50 – anti-personnel directional mine

Weight of explosives: 0.7 kg

Number of preformed fragments: 485-840

Casualty radius: 50-55 m

Range of lethal fragments: up to 80 m

Placed in the ground, trees or other supports.

This mine does not explain the powerful explosion, the formation of a crater, the symmetrical traces left on the ground by the explosion, the formation of traces on the body of the bus, or the traces on the bark of the tree (Illustration No. 12). Moreover, the MON-50 mine is supposed to be laid at an angle, not in accordance with Order No. 700 of the Ministry of Defense of Ukraine.

OZM-72 – anti-personnel non-directional bounding mine

This mine is closer in terms of its circular damage area [and] number of fragments to the warhead of a fragmentation shell.

Weight of explosives: 066 kg

Number of preformed fragments (metal balls and cylinders): 2,400

Casualty radius: 25 m

Range of lethal fragments: up to 50 m

Height of explosion above ground surface: 0.6–0.9 m

This mine is laid in the ground, and upon activation (the breaking of the anchor wire or, in the case of the remote-controlled version, the sending of a signal) explodes to a height of 0.6–0.9 m, which does not explain the formation of a crater with a depth of 0.45 m. Moreover, upon inspection of the scene of the incident, not a single standard preformed fragment of an OZM-72 mine (metal cylinders or balls) was found either in the bus or on the surrounding territory.

In addition, this mine does not explain the powerful explosion, symmetrical traces on the ground, or large fragments, traces of which are clearly visible on the body of the bus.

Moreover, elements of the rocket portion of a 122-mm unguided M21OF were found in the crater, but the tube that remains after the activation of an OZM-72 was not found.

Based on the foregoing, one can conclude that objects Nos. 1–5, which were submitted for examination, were formed from the explosion of a 122-mm unguided M-21 OF rocket-propelled high-explosive fragmentation shell (item 9M22U).

The following damage was found on the bus submitted for examination:

1) The rear panel is damaged by 4 through holes, and the rear window is shattered (Illustration No. 20).

2. The right side panel is damaged by 68 through holes of varying diameters:

- the windows are completely destroyed in the rear and on the right and left sides, and the front windshield has extensive damage (Illustrations No. 13, 15–17 and 21);

- the rear panel is damaged by 4 through holes (Illustration No. 20);

- the right rear door is damaged by 5 through holes and 1 blind hole (Illustration No. 16);

- the right front door is damaged by 8 through holes and 4 blind holes (Illustration No. 15);

- the roof of the bus is damaged by 11 through holes greater than 4x5 cm (Illustration No. 19);

- the section beneath the windows on the right side of the body of the bus (between the doors) is damaged in 33 places (Illustration No. 17);

- the lid of the tool box is damaged by 3 through holes and 1 blind hole;

- the front body section is damaged in 2 places (Illustration No. 21);
- the blinds of the bus on the right side are damaged by numerous tears (Illustration No.)
[sic];

- the right front wheel has a 5-cm gash (Illustration No. 18).

The largest concentration of damage is centered 1 m from the front doors at a height of 1.2 m above the ground (Illustration No. 17).

The damage to the TATA A07A bus with number plate AN 0985 AA bound from Zlatoustivka to Donetsk was the result of penetration of the body of the bus by fragmentation elements of various diameters, which had sufficient kinetic energy as a result of the explosion of a 122-mm unguided M-21 OF rocket-propelled high-explosive fragmentation shell.

According to incident site inspection report dated 02/13/15, the distance from the bus to the crater (the source of formation of the destructive agents) was 12 m. Since the longitudinal axis of the bus virtually coincides with the longitudinal trajectory of the shell's flight path, the right side surface of the bus will be virtually perpendicular to the fragment dispersion plane. Based on the foregoing, one can establish the angle of incidence of the shell, which is perpendicular (normal) to the fragment dispersion plane.

The destructive effect of the warhead of an M-21OF high-explosive fragmentation shell (9M22U) can be divided into two parts: high-explosive and fragmentation.

High-explosive effect

Let us assess the impact of the high-explosive destructive effect. The blast wave is a compression zone characterized by a sharp spike in pressure, density and temperature that spreads at supersonic speed in every direction from the site of the explosion. Empirically obtained, the formula devised by M.A. Sadovsky allows us to establish the approximate value of the overpressure of the blast wave in the event of a ground explosion.

$$P_{\Phi} = 0.106 \times \sqrt[3]{G} / R + 0.43 \times \sqrt[3]{G}^2 / R^2 + 1.4 \times G / R^3$$

Where G = weight of explosives in kg, R = distance to explosion point.

Substituting the value 6.4 kg and 12.0 m respectively, we get:

$$P_{\Phi} = 0.016 + 0.012 + 0.005 = 0.033 \text{ MPa} = (0.33 \text{ kg/cm}^2) = 33 \text{ kPa.}$$

A blast wave with such overpressure could be sufficient to cause a moderate level of damage to a Unimog vehicle, and according to the data in Table 3.10 such a blast wave is capable of inflicting major damage on passenger cars and buses.

However, the data in Table 3.10 are only accurate for cases where the duration of the blast wave significantly exceeds the period of the object's free oscillations, i.e., for the explosion of a fuel-air mixture (FAM). In our case, we were not able to determine this period. We can note, however, that the duration of the blast wave in our case was approximately 0.07 s.

According to the *Methods of Complex Analysis of Explosive Devices, Explosive Substances and Traces of Explosions*, a blast wave with overpressure of 0.33 kg/cm² is capable

of inflicting major damage on most brick and wooden structures.

We can also point out that the short period of free oscillations of eardrums enables us to determine that all of the passengers who were on the bus could have temporarily lost their hearing (lower threshold of 2.0 kPa, Table 7.2.5), and those who were closest to the epicenter of the explosion could have sustained some damage to their eardrums (lower threshold of 34 kPa). However, the overpressure of the blast wave is in direct proportion to the distance to the explosion. This correlation is shown in the diagram below:

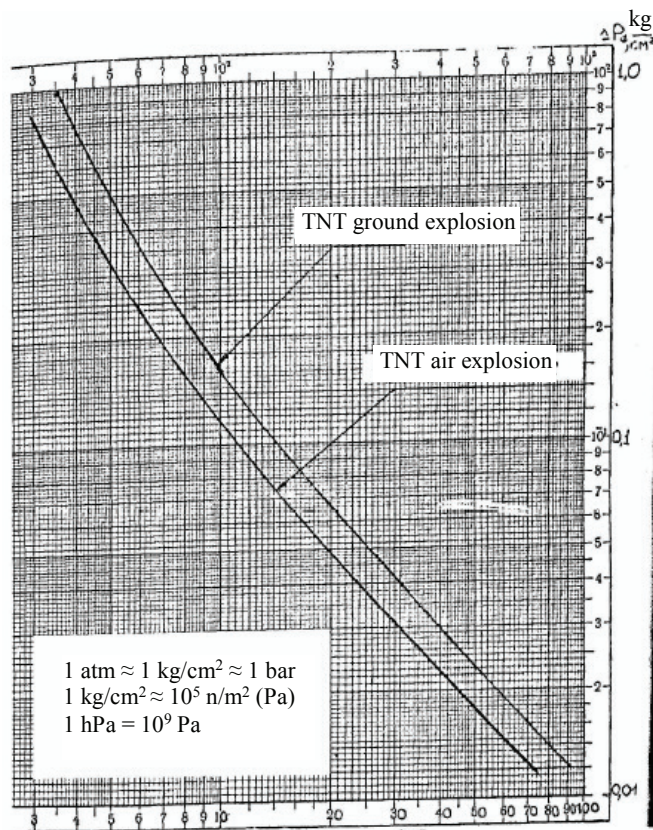

Figure 1. Changes in overpressure on the front of a blast wave depending on distance traveled.

Fragmentation effect

In addition to blast wave damage, a Grad multiple rocket launcher also hits its target with fragments.

According to data from Splav Research and Production Association OJSC, an M-21OF shell (9M22U) forms 1,640 preformed fragments (weighing 2.4 g) and 2,280 fragments from the shell body (weighing an average of 2.9 g). In total, 3,920 fragments weighing 2.4–2.9 g are formed.

Let us estimate the number of fragments that may have struck the bus.

According to the incident site inspection report dated 02/13/15, the distance from the right side section of the bus to the crater (the source of formation of the destructive agents) was 11.5 m. Looking at the diagram from above, we can see a right triangle formed by the side plane

of the bus and the downward normal. Then the sector that covers the bus can be calculated using the formula $\arctg = \arctg (7.4/12) - \arctg (0.64) = 0.5525 \text{ rad} = 31.7^\circ$.

7.4 m is the length of a ZAZ A07A1 I-VAN bus.

In other words, of the 3,920 fragments that flew in all directions, we get $3,920 \times 31.7 / 360 = 345$ fragments. That is to say, 47 fragments hit each meter of length of the side of the bus, or 4.7 fragments every 10 cm.

Thus, we can conclude that the fragmentation effect was the main cause of human fatalities. It was insufficient to completely destroy the body of the bus, but sufficient to cause the damage shown in the photographs (Illustration Nos. 13–21).

In order to answer the question of whether the damage could have been caused by gunfire hitting the bus, it should be noted that if the shooters had fired at the bus in such a way that the hits were distributed in an even band extending toward the ground, then:

- they would not have left a crater;
- they would not have left a cloud of smoke as can be seen in the video recording from the camera mounted on the roof of the State Traffic Inspectorate post;
- the holes in the body of the bus would be regular in shape, not square, triangular, oval, etc., which is not characteristic of the traces left by firearms (Illustration Nos. 13–20). In addition, the irregular-shaped and different-sized markings on the tree are not characteristic of the traces left by firearms (Illustration No. 12).

CONCLUSIONS

The TATA A07A bus with number plate AN 0985 AA that was submitted for examination sustained the following damage:

- the windows of the bus are completely destroyed, except for the front windshield, which is cracked;
- the rear panel is damaged by 4 through holes;
- the right rear door is damaged by 5 through holes and 1 blind hole;
- the right front door is damaged by 8 through holes and 4 blind holes;
- the roof of the bus is damaged by 11 through holes greater than 4x5 cm;
- the section beneath the windows on the right side of the body of the bus (between the doors) is damaged in 33 places;
- the lid of the tool box is damaged by 3 through holes and 1 blind hole;
- the front body section is damaged in 2 places;
- the largest concentration of damage is centered 1 m from the front doors at a height of 1.2 m above the ground;
- the blinds of the bus on the right side are damaged by numerous tears;

The damage to the TATA A07A bus with number plate AN 0985 AA bound from Zlatoustivka to Donetsk was the result of penetration of the body of the bus by fragmentation elements of various diameters, which had sufficient kinetic energy as a result of the explosion of

a 122-mm unguided M-21 OF rocket-propelled high-explosive fragmentation shell.

According to incident site inspection report dated 02/13/15, the distance from the bus to the crater (the source of formation of the destructive agents) was 12 m. Since the longitudinal axis of the bus virtually coincides with the longitudinal trajectory of the shell's flight path, the right side surface of the bus will be virtually perpendicular to the fragment dispersion plane. Based on the foregoing, one can establish the angle of incidence of the shell, which is perpendicular (normal) to the fragment dispersion plane.

The mechanical damage to the bus submitted for expert examination was caused by a single factor responsible for the formation of destructive agents (the explosion of a 122-mm unguided M-21 OF rocket-propelled high-explosive fragmentation shell (item 9M22U)).

The destructive agents found during the examination of the bus, the impact of which caused the damage found during the examination of the bus, were formed as a result of the explosion of a 122-mm unguided M-21 OF rocket-propelled high-explosive fragmentation shell (item 9M22U).

The mechanical damage to the bus submitted for expert examination was caused instantaneously.

Objects Nos. 1-5 are fragmentation elements of the fragmentation jacket of a 122-mm unguided M-21 OF rocket-propelled high-explosive fragmentation shell (item 9M22U), which were formed as a result of the explosion of a 122-mm unguided M-21 OF rocket-propelled high-explosive fragmentation shell (item 9M22U).

The damage to the bus found during the examination and the fragmentation elements removed from the passenger section of the bus could not have been formed from the explosion of a stationary landmine or from gunfire directed at the bus (see the description section).

Exhibit: illustrations table (7 pages)

Expert:

V. Stasyuk

[stamp:] Ukrainian Scientific Research Institute for Special Equipment and Forensic Expert Examinations of the Security Service of Ukraine,
Ref. No. <u>18/4-3596</u> , <u>05/19/2015</u> , main <u>12</u> exhibits --- pages

Annex 127

Administrative Directorate of the General Staff of the Armed Forces of Ukraine
Letter No. 300/1/C/2801 (29 May 2015)

This document has been translated from its original language into English, an official language of the Court, pursuant to Rules of the Court, Article 51.

Pursuant to Rules of the Court Article 51(3), Ukraine has translated only an extract of the original document constituting this Annex. In further compliance with this Rule, Ukraine has provided two certified copies of the full original-language document



**MINISTRY OF DEFENSE OF UKRAINE
GENERAL STAFF OF THE ARMED FORCES OF
UKRAINE**

6 Povitroflotsky Prospect, Kyiv, 03168. Phone: (044) 226-26-56. Fax: (044) 226-26-56

Email: kabmin_doc@mil.gov.ua

Code in the Uniform Register of Businesses and Organizations of Ukraine: 22991050

_____ No. _____

Administrative Directorate of the General Staff of the
Armed Forces of Ukraine

Foreign Ministry of Ukraine

No. 300/1/C/2801 of May 29, 2015

4:58:14 pm Pages: 1/1



11352114250893971179

In pursuance of Instruction No. 02-01/2948 of October 15, 2014 issued by the Ukrainian Presidential Chief of Staff, presented herewith are informational reference materials pertaining to the body of evidence for the presence of foreign military groups in Ukrainian territory, to be used in raising the awareness of Ukrainian society and international partners more actively and in the future lawsuits to be filed by Ukraine with the relevant international courts.

Attachment: above-mentioned information on 1 page, unclassified, for the specified recipient only

Acting First Deputy Chief
of the General Staff of the Armed Forces of Ukraine
Major General [Signature]

V.M. NAZAROV

R.O. Tarasenko, 454-40-78

FOREIGN MINISTRY OF UKRAINE
DEPARTMENT OF THE GENERAL SECRETARIAT
Incoming Ref. No. 47669
June 4, 2015

000064*

Order 50-2015

INFORMATIONAL REFERENCE MATERIALS

pertaining to the body of evidence for the direct invasion by foreign military groups into Ukrainian territory

I. Regarding the involvement of Russian citizens in illegal paramilitary groups operating in Eastern Ukraine

No documented facts of the involvement of Russian citizens in illegal paramilitary groups operating in Eastern Ukraine were recorded last week.

II. Regarding the chronology of the crossing of the state border of Ukraine by personnel, weapons, and military vehicles of the Armed Forces of the Russian Federation

No.	Date	Border crossing point crossed	Point of destination (crossing)	Number of convoys	Number of vehicles (personnel)
1.	May 27	USPENKA	DONETSK		8 trucks (including 2 trucks carrying personnel)
2.		To the Russian Federation	USPENKA		60 military vehicles (types to be updated)
3.		DMYTRIVKA	STEPANIVKA		20 KamAZ trucks
4.	May 26	MATVEYEV KURHAN	DONETSK	1	10 self-propelled guns and 5 trucks carrying personnel
5.		IZVARYNE	KRASNODON, NOVOFEDORIVKA, LUTUHINE		20 unmarked tanks
6.		IZVARYNE	Russian Federation	1	17 Ural and KamAZ trucks (presumably empty)
7.	May 25	To the Russian Federation	USPENKA		4 tarpaulin trucks
8.	May 25	USPENKA	DONETSK		18 tarpaulin trucks
9.	May 25	USPENKA	DONETSK	2	10 self-propelled guns, 23 trucks (including 5 trucks carrying personnel)
10.		HUKOVO, IZVARYNE, USPENKA			3 trucks with personnel left for the Russian Federation; 17 trucks (empty); 4 trucks
11.	May 24	IZVARYNE	LUHANSK		7 heavy artillery tractors with ammunition
12.	May 22	DMYTRIVKA	STEPANIVKA		10 KamAZ tarpaulin trucks and 2 BMP infantry fighting vehicles
13.	May 22	USPENKA			10 tarpaulin trucks and 2 BMP infantry fighting vehicles
14.	May 22	IZVARYNE			22 tarpaulin trucks

Acting Chief of the Main Command Center
of the Armed Forces of Ukraine

Major-General

[Signature]

O.S. SYRSKYI

Annex 128

Administrative Directorate of the General Staff of the Armed Forces of Ukraine
Letter No. 300/1/C/2917 (5 June 2015)

This document has been translated from its original language into English, an official language of the Court, pursuant to Rules of the Court, Article 51.

Pursuant to Rules of the Court Article 51(3), Ukraine has translated only an extract of the original document constituting this Annex. In further compliance with this Rule, Ukraine has provided two certified copies of the full original-language document



GENERAL STAFF OF THE ARMED FORCES OF UKRAINE

6 Povitroflotsky Prospect, Kyiv-168, Ukraine

Phone: (044) 234-01-92. Fax: (044) 226-26-56

Administrative Directorate of the General Staff of the
Armed Forces of Ukraine

Foreign Ministry of Ukraine

No. 300/1/C/2917 of June 5, 2015

10:00:29 am Page: 1/1



In pursuance of Instruction No. 02-01/2948 of October 15, 2014 issued by the Ukrainian Presidential Chief of Staff, presented herewith are informational reference materials pertaining to the body of evidence for the presence of foreign military groups in Ukrainian territory, to be used in raising the awareness of Ukrainian society and international partners more actively and in the future lawsuits to be filed by Ukraine with the relevant international courts.

Attachment: above-mentioned information on 1 page, unclassified, for the specified recipient only

First Deputy Chief of the General Staff
of the Armed Forces of Ukraine

Colonel General

[Signature]

H.P. VOROBYOV

V.A. Khomenko, 454-40-78

FOREIGN MINISTRY OF UKRAINE
DEPARTMENT OF THE GENERAL SECRETARIAT
Incoming Ref. No. 49581
June 20, 2015

000205*

Order 84-2014

INFORMATIONAL REFERENCE MATERIALS

pertaining to the body of evidence for the direct invasion by foreign military groups into Ukrainian territory

I. Regarding the involvement of Russian citizens in illegal paramilitary groups operating in Eastern Ukraine.

No documented facts of the involvement of Russian citizens in illegal paramilitary groups operating in Eastern Ukraine were recorded last week.

II. Regarding the chronology of the crossing of the state border of Ukraine by personnel, weapons, and military vehicles of the Armed Forces of the Russian Federation

No.	Date	Border crossing point crossed	Point of destination (crossing)	Number of convoys	Number of vehicles (personnel)
1.	June 3	IZVARYNE	LUHANSK	1	30 trucks;
2.		MARYNIVKA	SNIZHNE		11 trucks and 3 TOS-1 "Buratino" multiple rocket launchers
3.	May 31	IZVARYNE	LUHANSK		6 trucks carrying artillery ammunition
4.	May 31	Russian territory	DONETSK		10 freight cars with ammo
5.	May 29	Russian Federation	Railway station KHARTSYZK	Train	carrying up to 17 military vehicles (including up to 15 armored personnel carriers, up to 2 T-72 tanks)
6.	May 29	IZVARYNE	LUHANSK		Up to 22 trucks (including 20 trucks with ammo and munitions and 2 trucks carrying personnel)
7.	May 28	MATVEYEV KURHAN	through AMVROSIYIVKA in the direction of SHAKHTARSK, DEBALTSEVE		30 tarpaulin heavy artillery tractors and up to 30 armored fighting vehicles (tanks, armored personnel carriers, self-propelled guns)
8.	May 28	IZVARYNE	LUHANSK		Up to 20 T-72 tanks, 10 BMP-2 infantry fighting vehicles, and 6 trucks carrying personnel
9.		IZVARYNE	LUHANSK		Up to 25 BMP infantry fighting vehicles, 1 MTLB light-armored multipurpose tracked towing vehicle, 25 trucks carrying munitions and ammo
10.		IZVARYNE	LUHANSK		28 th "Humanitarian Convoy" of 50 trucks
11.		USPENKA	DONETSK		28 th "Humanitarian Convoy" of 52 trucks

Acting Chief of the Main Command Center
of the Armed Forces of Ukraine

Major-General

[Signature]

O.S. SYRSKYI

Annex 129

Administrative Directorate of the General Staff of the Armed Forces of Ukraine
Letter No. 300/1/C/3068 (13 June 2015)

This document has been translated from its original language into English, an official language of the Court, pursuant to Rules of the Court, Article 51.

Pursuant to Rules of the Court Article 51(3), Ukraine has translated only an extract of the original document constituting this Annex. In further compliance with this Rule, Ukraine has provided two certified copies of the full original-language document



**GENERAL STAFF
OF THE ARMED FORCES OF UKRAINE**

6 Povitroflotsky Prospect, Kyiv-168, Ukraine
Phone: (044) 234-01-92. Fax: (044) 226-26-56

Administrative Directorate of the General Staff of the Armed Forces of Ukraine Foreign Ministry of Ukraine

No. 300/1/C/3068 of June 13, 2015

19:52:41 Page: 1/4



00692432133615733038

In pursuance of Instruction No. 02-01/2948 of October 15, 2014 issued by the Ukrainian Presidential Chief of Staff, presented herewith are informational reference materials pertaining to the body of evidence for the presence of foreign military groups in Ukrainian territory, to be used in raising the awareness of Ukrainian society and international partners more actively and in the future lawsuits to be filed by Ukraine with the relevant international courts.

Attachment: above-mentioned information on 4 pages, unclassified, for the specified recipient only.

First Deputy Chief of the General Staff
of the Armed Forces of Ukraine

Colonel-General

[Signature]

H.P. VOROBYOV

[Typed by] O.O. Dudnyk, 454-40-78

FOREIGN MINISTRY OF UKRAINE
DEPARTMENT OF THE GENERAL SECRETARIAT
Incoming Ref. No. 52397
June 18, 2015

000161*

235-20-12

INFORMATIONAL REFERENCE MATERIALS

pertaining to the body of evidence for the direct invasion by foreign military groups into Ukrainian territory

I. Regarding the involvement of Russian citizens in illegal paramilitary groups operating in Eastern Ukraine.

At around 6:40 a.m. on June 3, 2015, a civilian passenger car exploded on a forest road after detonation of a mine explosive planted by illegal paramilitary groups near the village of KRIAKIVKA, Novoaydarsk District (two local residents were killed).

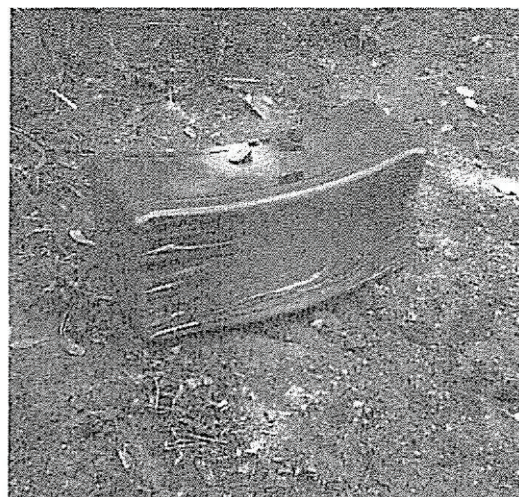

A sabotage and reconnaissance group was detected at around 9:00 a.m. on May 7, 2015 in the vicinity of Urochishche Balka and population center of NOVOTOSHKIVKA, Luhansk Oblast. The following items were captured after the group was engaged in combat: one RPG-7N2 handheld grenade launcher No. GT982; one TBG-7V grenade, and a spent Russian-made first aid dressing kit.

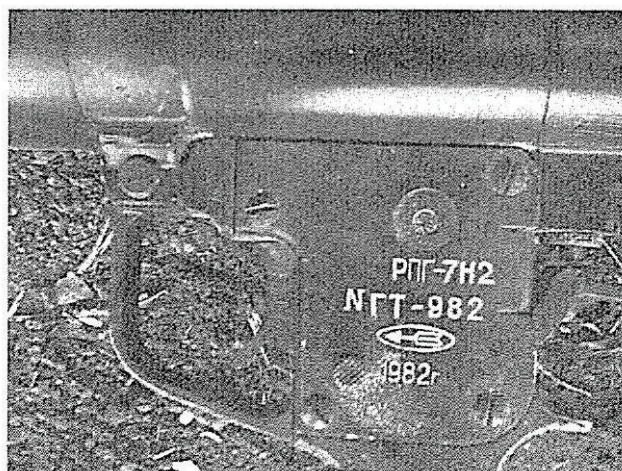
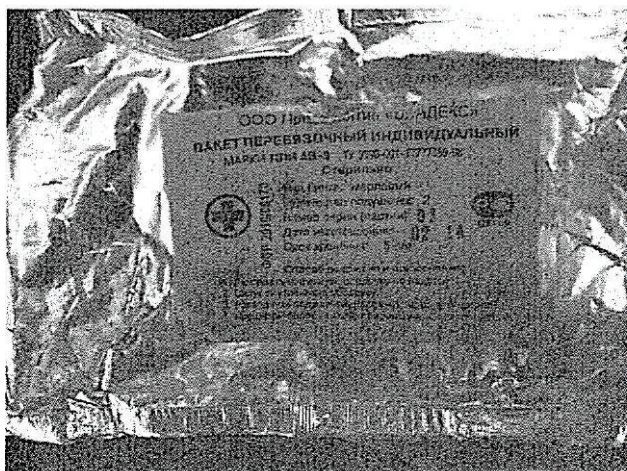
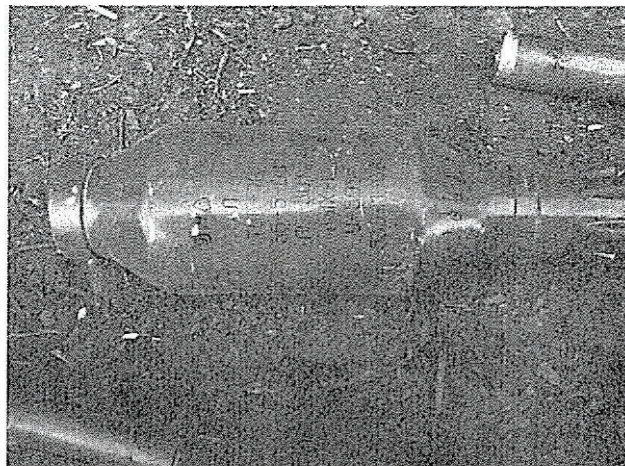

On May 4, 2015, a counter-sabotage mission in the vicinity of the population center of NOVOTROITSKE, Donetsk Oblast, resulted in the capture of a GP-34 under-barrel grenade launchers (available to the Russian Armed Forces only) and a Kizlyar knife (available to units of the special forces of the Russian Armed Forces).

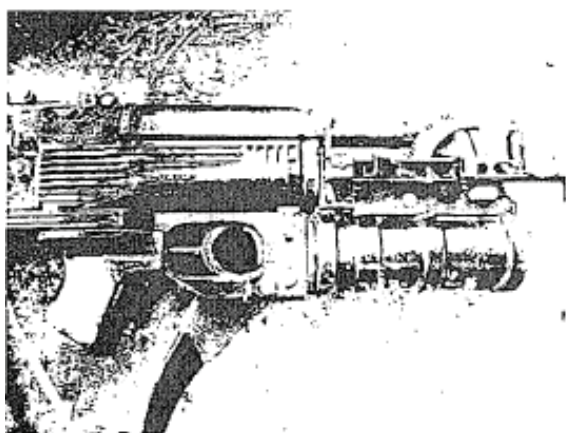
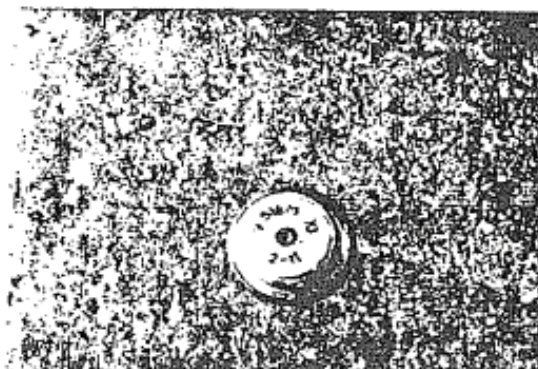
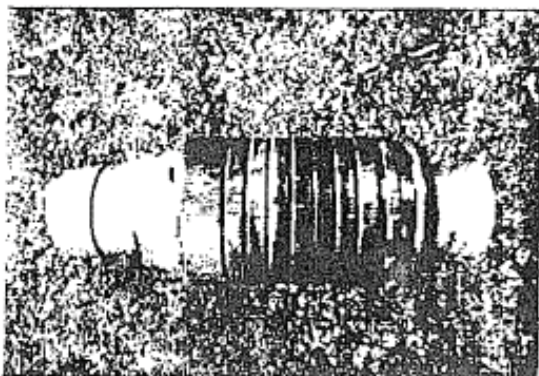
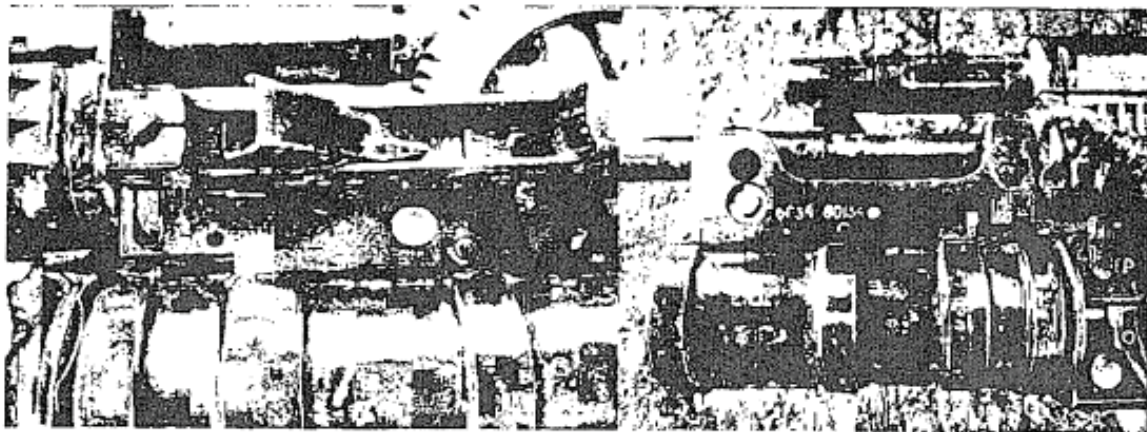

II. Regarding the chronology of the crossing of the state border of Ukraine by personnel, weapons, and military vehicles of the Armed Forces of the Russian Federation

No	Date	Border crossing point crossed	Point of destination (crossing)	Number of convoys	Number of vehicles (personnel)
1.	10.06	From the Russian Federation	to the population center of SEDOVO	1	SAU self-propelled guns – 14 units, BTR-82 armored personnel carriers – 4 units, BM-21 multiple rocket launchers – 6 units, trucks with ammo – 20 units
2.	09.06	From the Russian Federation	Krasnaya Mogila railway station	Train	With military vehicles (20 platforms) and personnel (10 rail cars)
3.	6-7.06	From the Russian Federation	LUHANSK	2 Trains	With armored vehicles (under tarpaulins) – 1st train with up to 50 armored fighting vehicles; 2nd train – 41 platforms.
4.		From the Russian Federation	LUHANSK	1	Train carrying personnel, military vehicles and weapons. Belonging, quantity of personnel and vehicles and types of vehicles to be updated
5.		To the Russian Federation	IZVARINE		19 trucks crossed the border into Russia
6.	6.06	NOVOAZOVSK	BEZIMENNE	1	Five SAU self-propelled guns
7.		CHERVONOPARTYZANSK	SIMEYKYNE	1	A train carrying personnel (four passenger rail cars) and military vehicles (number to be updated)
8.		From the Russian Federation	ZELENYI HAI (Telmanovka District)	1	8 tarpaulin trucks with canon in tow;
9.		To the Russian Federation	IZVARINE	1	5 trains carrying military vehicles (types and quantity to be updated)

Acting Chief of the Main Command Center
of the Armed Forces of Ukraine

Major-General

[Signature]

O.S. SYRSKYI

Annex 130

Administrative Directorate of the General Staff of the Armed Forces of Ukraine
Letter No. 300/1/C/3309 (26 June 2015)

This document has been translated from its original language into English, an official language of the Court, pursuant to Rules of the Court, Article 51.

Pursuant to Rules of the Court Article 51(3), Ukraine has translated only an extract of the original document constituting this Annex. In further compliance with this Rule, Ukraine has provided two certified copies of the full original-language document



**MINISTRY OF DEFENSE OF UKRAINE
GENERAL STAFF OF THE ARMED FORCES OF
UKRAINE**

6 Povitroflotsky Prospect, Kyiv, 03168. Phone: (044) 226-26-56. Fax: (044) 226-26-56

Email: kabmin_doc@mil.gov.ua

Code in the Uniform Register of Businesses and Organizations of Ukraine: 22991050

_____ No. _____

Administrative Directorate of the General Staff of the
Armed Forces of Ukraine

Foreign Ministry of Ukraine

No. 300/1/C/3309 of June 26, 2015

10:45:51 am Pages: 1/2



10544537698102233348

In pursuance of Instruction No. 02-01/2948 of October 15, 2014 issued by the Ukrainian Presidential Chief of Staff, presented herewith are informational reference materials pertaining to the body of evidence for the presence of foreign military groups in Ukrainian territory, to be used in raising the awareness of Ukrainian society and international partners more actively and in the future lawsuits to be filed by Ukraine with the relevant international courts.

Attachment: above-mentioned information on 2 pages, unclassified, for the specified recipient only

First Deputy Chief
of the General Staff of the Armed Forces of Ukraine

Colonel-General

[Signature]

H.P. VOROBYOV

O.S. Strilchuk, 454-40-78

FOREIGN MINISTRY OF UKRAINE
DEPARTMENT OF THE GENERAL
SECRETARIAT
Incoming Ref. No. 57201
July 3, 2015

000827*

Order 155-15

INFORMATIONAL REFERENCE MATERIALS

pertaining to the body of evidence for the direct invasion by foreign military groups into Ukrainian territory

I. Regarding the involvement of Russian citizens in illegal paramilitary groups operating in Eastern Ukraine

No documented facts of the involvement of Russian citizens in illegal paramilitary groups operating in Eastern Ukraine were recorded last week.

II. Regarding the chronology of the crossing of the state border of Ukraine by personnel, weapons, and military vehicles of the Armed Forces of the Russian Federation

No.	Date	Border crossing point crossed	Point of destination (crossing)	Number of convoys	Number of vehicles (personnel)
1.	June 25	DONETSK border crossing point and MATVEYEV KURHAN border crossing point	in the direction of DONETSK and LUHANSK.	Truck convoys of the Russian Ministry for Emergencies of the 31 st "Humanitarian Convoy"	101 trucks with over 1,000 tonnes of humanitarian cargo (food and medication). In addition, army semi-trailers were loaded into the trailers of some of the trucks (this information needs to be verified).
2.	June 23	USPENKA	ILOVAYSK	1	30 trucks
3.	June 22	MATVEYEV KURHAN	To the Russian Federation	Train	with military vehicles (50 tanks, 20 armored fighting vehicles, 30 trucks) – to be updated
4.	June 21	From the Russian Federation	DEBALTSEVE railway station	Train	with military vehicles: up to 50 tanks, 20 armored fighting vehicles, 30 trucks
5.	June 21	IZVARYNE	To the Russian Federation	1	25 tarpaulin trucks (presumably empty).
6.	June 21	From the Russian Federation	DMYTRIVKA	1	9 trucks with ammunition and a bus carrying personnel.
7.	June 20	IZVARYNE	LUHANSK	1	offroad vehicle (UAZ-Patriot of the hatchback modification), 7 URAL trucks (4 trucks with inventory supplies, 3 trucks with personnel), 2 UAZ-469 vehicles, 3 KamAZ-43269 "Vystrel" armored trucks, 1 GAZ-66 vehicle, 2 KamAZ trucks with trailers (water tank and mobile kitchen trailer).

No .	Date	Border crossing point crossed	Point of destination (crossing)	Number of convoys	Number of vehicles (personnel)
8.	June 20	IZVARYNE	LUHANSK	1	19 tarpaulin trucks (17 carrying personnel and 2 carrying munitions), special-purpose vehicle (with a hardtop canopy), UAZ vehicles and 1 crane (all of them unmarked and without number plates);
9.	June 20	RUSSIA - STAROBESHEVE	DONETSK	1	40 tanks, 12 GRAD BM-21 multiple rocket launchers;
10	June 19	USPENKA	SHEVCHENKO	Train	30 tanks, 9 self-propelled guns, trucks and personnel of the Russian Armed Forces;
11	June 19	IZVARYNE	LUHANSK	1	Up to 400 militants to be subsequently redeployed to DONETSK

Acting First Deputy Chief
of the Main Command Center of the Armed Forces of Ukraine

Major General

[Signature]

B.V. BONDAR

Annex 131

Administrative Directorate of the General Staff of the Armed Forces of Ukraine
Letter No. 300/1/C/3588 (10 July 2015)

This document has been translated from its original language into English, an official language of the Court, pursuant to Rules of the Court, Article 51.

Pursuant to Rules of the Court Article 51(3), Ukraine has translated only an extract of the original document constituting this Annex. In further compliance with this Rule, Ukraine has provided two certified copies of the full original-language document



**MINISTRY OF DEFENSE OF UKRAINE
GENERAL STAFF OF THE ARMED FORCES OF
UKRAINE**

6 Povitroflotsky Prospect, Kyiv, 03168. Phone: (044) 226-26-56. Fax: (044) 226-26-56

Email: kabmin_doc@mil.gov.ua

Code in the Uniform Register of Businesses and Organizations of Ukraine: 22991050

_____ No. _____

Administrative Directorate of the General Staff of the
Armed Forces of Ukraine

Foreign Ministry of Ukraine

No. 300/1/C/3588 of July 10, 2015

2:22:21 pm Pages: 1/1



14636906007064628079

In pursuance of Instruction No. 02-01/2948 of October 15, 2014 issued by the Ukrainian Presidential Chief of Staff, presented herewith are informational reference materials pertaining to the body of evidence for the presence of foreign military groups in Ukrainian territory, to be used in raising the awareness of Ukrainian society and international partners more actively and in the future lawsuits to be filed by Ukraine with the relevant international courts.

Attachment: 1 page, 1 copy, for the specified recipient only.

Acting First Deputy Chief
of the General Staff of the Armed Forces of Ukraine

Major General

[Signature]

V.M. NAZAROV

V.A. Khomenko, 454-40-78

FOREIGN MINISTRY OF UKRAINE
DEPARTMENT OF THE GENERAL SECRETARIAT
Incoming Ref. No. 60671
July 15, 2015

000677*

Order 155-15

INFORMATIONAL REFERENCE MATERIALS

pertaining to the body of evidence for the direct invasion by foreign military groups into Ukrainian territory

I. Regarding the involvement of Russian citizens in illegal paramilitary groups operating in Eastern Ukraine

No documented facts of the involvement of Russian citizens in illegal paramilitary groups operating in Eastern Ukraine were recorded last week.

II. Regarding the chronology of the crossing of the state border of Ukraine by personnel, weapons, and military vehicles of the Armed Forces of the Russian Federation

No.	Date	Border crossing point crossed	Point of destination (crossing)	Number of convoys	Number of vehicles (personnel)
1.	July 6	From the Russian Federation	to Novoazovsk District	1	15 tanker trucks
2.	July 5	From the Russian Federation	to Novoazovsk District (location to be updated)	1	Seven 120-mm "Nona" SG2S9 self-propelled mortars (presumably an artillery unit of the marines or paratroopers of the Russian Armed Forces)
3.	July 2	From Rostov Oblast	to Markine	1	6 tanks, 100 people
4.	July 1	From Rostov Oblast	to Sverdlovsk	1 train	20 tanks, seven 122-mm GRAD multiple rocket launchers
5.	June 27	IZVARYNE	LUHANSK	1	13 trucks with ammunition and a tanker truck
6.	June 26	From the Russian Federation	presumably through the USPENKA border crossing point to TELMANOVE	1	12 tanker trucks crossed the border into the country.
7.		From the Russian Federation	NOVOAZOVSK	1	10 tanker trucks
8.	June 25	IZVARYNE	LUHANSK	1	31 st "Humanitarian Convoy" 50 trucks; 50 trucks.
9.		USPENKA	DONETSK	1	

10.	June 24-25	USPENKA	through KOMSOMOLSKE in the direction of NOVOAZOVSK	2	(armored personnel carriers, number to be updated)
11.			MNOHOPOLYE and POLTAVSKE (4 km south of ILOVAYSK)		second group – up to 180 people, 10 URAL trucks (including 6 D-30 trucks), 8 BMP infantry fighting vehicles, up to 10 BTR armored personnel carriers)

Acting Chief
of the Main Command Center of the Armed Forces of Ukraine
Major General

[Signature]

B.V. BONDAR

Annex 132

Administrative Directorate of the General Staff of the Armed Forces of Ukraine
Letter No. 300/1/C/3739 (20 July 2015)

This document has been translated from its original language into English, an official language of the Court, pursuant to Rules of the Court, Article 51.

Pursuant to Rules of the Court Article 51(3), Ukraine has translated only an extract of the original document constituting this Annex. In further compliance with this Rule, Ukraine has provided two certified copies of the full original-language document



**MINISTRY OF DEFENSE OF UKRAINE
GENERAL STAFF OF THE ARMED FORCES OF
UKRAINE**

6 Povitroflotsky Prospect, Kyiv, 03168. Phone: (044) 226-26-56. Fax: (044) 226-26-56

Email: kabmin_doc@mil.gov.ua

Code in the Uniform Register of Businesses and Organizations of Ukraine: 22991050

_____ No. _____
Administrative Directorate of the General Staff of the
Armed Forces of Ukraine

Ministry of Foreign Affairs of Ukraine

No. 300/1/C/3739 of July 20, 2015

9:01:44 am Pages: 2



11449227878874366974

In pursuance of Instruction No. 02-01/2948 of October 15, 2014 issued by the Ukrainian Presidential Chief of Staff, presented herewith are informational reference materials pertaining to the body of evidence for the presence of foreign military groups in Ukrainian territory, to be used in raising the awareness of Ukrainian society and international partners more actively and in the future lawsuits to be filed by Ukraine with the relevant international courts.

Attachment: 1 page, 1 copy, for the specified recipient only.

Acting First Deputy Chief
of the General Staff of the Armed Forces of Ukraine

Major General

[Signature]

V.M. NAZAROV

V.I. Bodnya, 454-40-78

MINISTRY OF FOREIGN AFFAIRS OF UKRAINE
DEPARTMENT OF THE GENERAL SECRETARIAT
Incoming Ref. No. 63197
July 23, 2015

001031*

Order 191-2015

INFORMATIONAL REFERENCE MATERIALS

pertaining to the body of evidence for the direct invasion by foreign military groups into Ukrainian territory

I. Regarding the involvement of Russian citizens in illegal paramilitary groups operating in Eastern Ukraine

No documented facts of the involvement of Russian citizens in illegal paramilitary groups operating in Eastern Ukraine were recorded last week.

II. Regarding the chronology of the crossing of the state border of Ukraine by personnel, weapons, and military vehicles of the Armed Forces of the Russian Federation

No.	Date	Border crossing point crossed	Point of destination (crossing)	Number of convoys	Number of vehicles (personnel)
1	July 16	From the Russian Federation	LUHANSK	1	32 nd “Humanitarian Convoy” 52 trucks
			DONETSK	1	50 trucks
2	July 12	From the Russian Federation	ILOVAYSK railway station	Train	4 freight cars with ammo and 1 rail tank car with fuel (the arrival of three more rail tank cars is expected)

Acting Chief
of the Main Command Center of the Armed Forces of Ukraine

Major General

[Signature]

B.V. BONDAR

Annex 133

Report on Status and Condition of Military Units and Formations of the 1st Army Corps of the DPR, Obtained and Preserved by Ukrainian Military Intelligence (31 July 2015)

This document has been translated from its original language into English, an official language of the Court, pursuant to Rules of the Court, Article 51.

Pursuant to Rules of the Court Article 51(3), Ukraine has translated only an extract of the original document constituting this Annex. In further compliance with this Rule, Ukraine has provided two certified copies of the full original-language document

REPORT

by

Commander, Operations Section

Colonel

USTINOV, Oleg Viktorovich

Status and condition of military units and formations,
1st Army Corps

Strength and Composition of Military Units and Formations in 1st Army Corps [1AC]

IAC

General military units and formations

<i>[left]</i>	<i>1st Separate Motorized Rifle Brigade</i>	<i>3rd Separate Motorized Rifle Brigade</i>	<i>5th Separate Motorized Rifle Brigade</i>	<i>7th Separate Motorized Rifle Brigade</i>
<i>[right]</i>	<i>Reconnaissance Group Brigade</i>	<i>9th Separate Motorized Rifle Regiment</i>	<i>11th Separate Motorized Rifle Regiment</i>	<i>Separate Tank Battalion</i>
<i>[left]</i>	Artillery units			
	<i>Artillery brigade</i>			
<i>[right]</i>	Anti-aircraft units			
	<i>Anti-Aircraft Missile Division</i>			

Military units and formations for first line logistic support, command, and control

<i>[left]</i>	<i>Separate Command Regiment</i>	<i>Separate Special Forces Battalion</i>	<i>Separate Intelligence Battalion</i>
<i>[right]</i>	<i>Separate Radioelectronic Warfare Company</i>	<i>Engineering and Sabotage Company</i>	<i>Security Administration Battalion</i>
<i>[left]</i>			

Logistics units

Separate Repair Battalion *Separate Logistics Battalion*

[right]

Territorial defense units

1st, 2nd, 3rd Territorial Defense Battalions *4th, 5th, 6th Territorial Defense Battalions*

Description	Number		Description	Number	
	before	after		before	after
Personnel	17441	21443	Tanks	288	320
Military units and formations, total	18	24	Armored cars	516	598
Including general military	8	8	Anti-aircraft guns	264	288
Motorized rifle battalion (tank battalion)	20(6)	25 (9)	MRLS	72	124
Artillery divisions	18	22	Mortars	144	180

Number of Pieces of Basic Arms and Military Equipment Before and After

Arms and military equipment	1st Separate Motorized Rifle Brigade		3rd Separate Motorized Rifle Brigade		5th Separate Motorized Rifle Brigade		7th Separate Motorized Rifle Brigade		Reconnaissance Group Brigade		9th Separate Motorized Rifle Regiment		11th Separate Motorized Rifle Regiment		Separate Tank Battalion		Total	
	before	after	before	after	before	after	before	after	before	after	before	after	before	after	before	after	before	after
Armored cars	101	104	101	104	101	104	101	104	-	46	43	83	43	83	13	3	516	598
Tanks	41	41	41	41	41	41	41	41	-	31	20	31	20	31	42	42	288	320
2S1 [howitzer]	24	24	24	24	24	24	24	24	-	24	24	24	24	24	6	-	156	168
d-30 [howitzer]	18	18	18	18	18	18	18	18	-	18	-	-	-	-	6	-	84	90
Grad MRLS	18	18	18	18	18	18	18	18	-	18	-	12	-	12	-	-	72	124
MT-12 [antitank gun]	6	6	6	6	6	6	6	6	-	6	-	-	-	-	-	-	24	30
9P135 [shoulder-fired anti-tank weapon]	27	27	27	27	27	27	27	27	-	27	27	36	27	36	-	-	162	207
9P516-1 [man-portable air defense system]	36	36	36	36	36	45	36	36	-	36	18	27	18	27	9	-	198	243
Utes machine gun	18	18	18	18	18	18	18	18	-	24	-	12	-	12	-	-	72	120
AGS-17 [grenade launcher]	18	18	18	18	18	12	18	18	-	18	4	4	4	4	-	-	80	92
Mortar	27	27	27	27	27	18	27	27	-	27	18	27	18	27	-	-	144	180

Annex 134

Intelligence Briefing from the Main Intelligence Directorate of the Ukrainian
Ministry of Defense No. 222/2D/1963dsk (14 September 2016)

This document has been translated from its original language into English, an official
language of the Court, pursuant to Rules of the Court, Article 51.

Pursuant to Rules of the Court Article 51(3), Ukraine has translated only
an extract of the original document constituting this Annex. In further
compliance with this Rule, Ukraine has provided two certified copies of the
full original-language document

[TRANSLATED EXTRACT OF EXHIBIT 2]

[State Symbol of Ukraine]
**MINISTRY OF DEFENSE
OF UKRAINE
MILITARY UNIT
A1145
September 14, 2016
No. 222/2D/1963dsk
03022, city of Kyiv-22
3 Trutenka St.**

[Handwritten marks]

For official use
(without attachment - open information)
Copy No.1

To the Commander of the Military Unit A0418
(via attendant on duty at service 21)

To the Commander of the Military Unit A0485
(via attendant on duty at department 45)

To the Commander of the Military Unit A0418

To the Commander of the Military Unit A0418
(via the Secret Operating Unit of GKRTs)

To the Commander of Operational Maneuver
Group of the Military Unit A1225

“To send by using the K31 means”

I am sending for your attention the information “**On development of the situation in the South-Eastern Regions of Ukraine**”.

- Attachments:
1. As mentioned in the text, Copy No.1, file \$D%D140912.rar, 09/14/2016, 1071 Kb, for official use, only to the first addressee.
 2. As mentioned in the text, Copy No.1, file \$D%D140913.rar, 09/14/2016, 136 Kb, for official use, only to the second addressee.
 3. As mentioned in the text, Copy No.1, file \$D%D140914.rar, 09/14/2016, 501 Kb, for official use, only to the third addressee.
 4. As mentioned in the text, Copy No.1, file \$D%D140915.rar, 09/14/2016, 1071 Kb, for official use, only to the fourth addressee.
 5. As mentioned in the text, Copy No.1, file \$D%D140916_1.rar, 09/14/2016, 10 Kb, for official use, only to the fifth addressee.

[Handwritten marks]

The Deputy Director of the Department -
Head of the Military Unit A05515 [redacted]
Colonel [redacted] [Signed]

[Stamp with handwritten marks]

[TRANSLATED EXTRACT OF EXHIBIT 2]
Not for distribution

[Symbol of the Department]

**Regarding development of the situation
in the area of ATO**

(during September 14, as of 08:00 of September 15)

[redacted]

[Stamp with handwritten marks]

[TRANSLATED EXTRACT OF EXHIBIT 2]

There is continuous and **regular provision of fuel and lubricants, military hardware and personnel from the territory of Russia** to the Russian occupational units on the temporary occupied territories of the Donetsk and Luhansk Regions, using the auto and railroad infrastructure.

It was observed on September 13 of this year, at approximately 8:20 pm, at the railroad station Illovaysk, that 5 rail cars with ammunition have arrived: 2 units with the 80 and 120-mm mortar projectiles, 2 units with the 122 and 152-mm rocket projectiles for self-propelled artillery platforms, and 1 unit with ammunition for BM-21.

It was observed on September 13 of this year, at approximately 8:00 pm, at the railroad station Khartsyzk, that an echelon with the military hardware has arrived including: 3 platforms with BM-21, 2 platforms with 2 units of tanks T-72, 3 platforms with infantry fighting vehicles BMP-2.

It was observed on September 13 of this year that an echelon of 12 tankers containing fuel and lubricants has arrived from the Russian Federation to the petroleum base in Rovenky. In addition, it was observed on the area of the petroleum base that 20 auto tankers were waiting to receive fuel at the base.

Annex 135

Expert opinion No. 14986/16-35, Kyiv Research Institute for Forensic Examinations
of the Ministry of Justice of Ukraine (12 October 2015)

This document has been translated from its original language into English, an official
language of the Court, pursuant to Rules of the Court, Article 51.

Pursuant to Rules of the Court Article 51(3), Ukraine has translated only
an extract of the original document constituting this Annex. In further
compliance with this Rule, Ukraine has provided two certified copies of the
full original-language document

MINISTRY OF JUSTICE OF UKRAINE
KYIV SCIENTIFIC RESEARCH INSTITUTE
OF FORENSIC EXPERTS
(KSRI-FE)

6 Smolenska Street, Kyiv, 03057
Tel. (044) 200 29 29 • Fax (044) 200 29 11 • E-mail: info@kniise.com.ua
Unified State Registry of Ukrainian Businesses and Organizations (YeDRPOU)
National Accreditation Agency of Ukraine Certificate No. 2N1141 of January 15, 2016
Ukrmetrteststandart State Enterprise Certificate No. PT-114/16 of July 14, 2016
State Property Fund of Ukraine Certificate No. 573/16 of July 29, 2016

EXPERT OPINION
Based on the Results of an
Audio Recording Examination

October 12, 2016

No. 14986/16-35

INTRODUCTION

On September 26, 2016, KSRI-FE received an order dated September 21, 2016 to perform an expert examination of video and audio recordings in criminal proceeding No. 2201505000000021 issued by Lt. Col. of Justice D. V. Zyuzya, Senior Investigating Officer in Major Cases of the First Pretrial Investigation Department of the Main Investigation Directorate of the Security Service of Ukraine.

The following has been issued simultaneously with the order:

- Two (2) compact disks without any manufacturer markings with registration numbers 3849 of April 11, 2016 and 3852 of April 11, 2016, respectively;
- CD-R disk, Verbatim 700 Mb 80 min, серійний №N1211G19D805231542
- CD-R disk, Verbatim 700 Mb 80 min, серійний №N1211G19D8064282F1
- CD-R disk, Verbatim 700 Mb 80 min, серійний № N1211G19D8063884A1;
- CD-R disk, Verbatim 700 Mb 80 min, серійний №N1211G19D8063879 F2;
- Record of the results of the operational technical investigation, Main Investigation Directorate of the Security Service of Ukraine incoming No. 7680 of September 20, 2016, on 10 sheets;
- Record of examination dated August 31, 2016, on 3 sheets;
- Three (3) records of examination dated August 29, 2016, on 3 sheets each.

[signature]

[text cut off] cross-correlation coefficients of spectral curves between spectrum bands, which represent integral characteristics of speech flow and reflect the distinctive features of, or interrelations between, the synchronous movements of the speaker's articulation organs.

Thus, with the Phonexi software package used, the vector of individualized acoustic characteristics consists of 501 characteristics, including 378 spectral characteristics and 123 main tone characteristics. The values of the 501 individualized characteristics for each 10-second speech segment of an unidentified speaker are recorded in computer memory and used for subsequent comparison with similar speaker speech characteristics recorded in the comparative samples provided.

The analysis was performed using the method of personal identification based on speech characteristics with the assistance of Phonexi 2.02 automated expert system.

The identification and comparison of certain parameters (ChOT characteristics, formant and anti-formant areas, and so on) of a speech signal and certain phonemes (sounds) were performed using Computerized Speech Lab Model 4500 (Kay Elemetrics Corp., USA) included in the basic software package.

In the process of analysis of audio recordings 380509604816-2015.01.13-09.22.26-537.wav, 380509604816-2015.01.13-11.56.55-615.wav, 380509604816-2015.01.13-12.46.33-641.wav, 380509604816-2015.01.13-13.55.14-666.wav, and 380509604816-2015.01.13-14.02.14-671.wav and the samples of citizen Yuriy Mykolayovych Shpakov, coincidence of the spectral characteristics vectors and OT characteristics was identified, namely, when comparing the speech characteristics of the speaker identified as "Yust" in the September 16, 2016 record of operational and technical investigation and the samples of Yu. M. Shpakov's speech.

CONCLUSIONS

The person participating in the conversations recorded in the audio recordings identified as files 380509604816-2015.01.13-09.22.26-537.wav, 380509604816-2015.01.13-11.56.55-615.wav, 380509604816-2015.01.13-12.46.33-641.wav, 380509604816-2015.01.13-13.55.14-666.wav, and 380509604816-2015.01.13-14.02.14-671.wav on a compact disk with registration number 3849 (No. 1) in the directory named p24=220ml 1, is citizen Yuriy Mykolayovych Shpakov.

The words and phrases spoken by him are marked as "Yust" in the September 16, 2016 record of operational and technical investigation.

[signature]

Ye. V. Tymko
Forensic Expert

Note: The following items are returned together with this Opinion:

- Two (2) compact disks without any manufacturer markings with registration . . . [text cut off]

Annex 136

Protocol of Inspection by I.V. Nimchenko, Senior Investigator on Special Cases of the
Main Military Prosecutor's Office, Prosecutor General's Office of Ukraine (28
October 2015)

This document has been translated from its original language into English, an official
language of the Court, pursuant to Rules of the Court, Article 51.

Pursuant to Rules of the Court Article 51(3), Ukraine has translated only
an extract of the original document constituting this Annex. In further
compliance with this Rule, Ukraine has provided two certified copies of the
full original-language document

Protocol of Inspection

City: Kyiv

28 October 2015

Interrogation commenced at 12:40 p. m.

Interrogation completed at 14:40 p. m.

Senior investigator on special cases of the Main Military Prosecutor's Office,
PGO of Ukraine I.V.Nimchenko.

in conformity with articles 104, 105, 106, 234, 237, 223 of the Code of Criminal
Procedure of Ukraine:

in attendance of attesting witnesses:

- 1) Yankovenko Oksana Oleksiivna, born in 1976, Brovary, Kyiv oblast (5,
Darvina Lane.)
- 2) Dudar Anatolyi Vasylovych, born in 1959, Kyiv. 38 Bilorusska St., ap. 102.
Who have been explained their rights and obligations under articles 11, 13,
15, 223 of the Code of Criminal Procedure of Ukraine

With the participation of the specialist:

Druginin Yuri Oleksandrovych,
Who has been explained his rights and obligations under par. 4, 5 of article
71 of the Code of Criminal Procedure of Ukraine,.

The inspection has been conducted at Kyiv City, 24, Lavrska St., and 33,
Lavrska St. and it has established:

.....
[Excerpts related to the BM-21 GRAD only]
.....

In addition, on an asphalted platform located near the memorial of
architecture and history "Brama" (at the distance of 10 m.). The asphalted platform
at size of 20 sq. m., on the right side towards the Museum of History of Ukraine in
the World War II (address: 24, Lavrska St.). There are three units of military
equipment located on the platform, namely:

A BM-21 "Grad" on the basis of the "Ural" truck. Near the BM-21 "Grad"
there is an information plate with the following content: "The rocket system BM-
21 "Grad" was captured on 13 June 2014 near the settlement of Dobropillia,
Donetsk oblast. The affiliation of the system with the Armed Forces of the RF is
supported by the following facts: during inspection, the elements of military
ammunition produced in Russian as well as a shelling chart for BM-21 with a

mastic seal imprint of military unit №27777 were found. In addition, a trace of a tactical insignia was found on the cabin doors (a rhomb in a square) which confirms the affiliation of the truck with the 18th Separate Motorized Rifle Brigade of the 58th Army of the Southern Military District, Armed Forces of the Russian Federation. (Chechen Republic). The same content is written in Russian and English on the information plate.

During the inspection, it has been established that the BM-21 “Grad” has numerous damages on the cabin of the “Ural” truck; headlights, marker lights and turning lights are absent. The truck is painted in grey and black. On the right side of the front bumper, a figure 4 (four) and an unreadable inscription is written with white paint. On the driver’s and passenger’s doors of the BM-21 “Grad”, being partially painted out with gray and black colors, a geometric composition can be seen: – a rhomb inside of a square (16 sm.). The aforementioned picture was stenciled. The hood and radiator grille of the “Ural” truck have damages (dents). The windshield and passenger window and the driver's door is not damaged. The windscreen as well as the doors’ glasses are not damaged. The doors are welded sealed (an access into the cabin is impossible). A part of the hood cover is welded to exclude an access to the engine compartment of the BM-21 “Grad”.

.....

During the inspection the following technical means have been used:

Photography with the use of a photo camera “Olympic – E 510”.

The inspection was carried out: the weather was cloudy, rainy, +9 Celsius, with natural lighting.

The protocol has been read, the records are correct, no observations.

Participants

1. Druginin I. O. Signed

Attesting witnesses:

1. Iankovenko Oksana Oleksiivna Signed

2. Dudar Anatolyi Vasylovych Signed

The inspection has been carried out by senior investigator for special cases of the Main Military Prosecutor’s Office, PGO of Ukraine.

I. V. Nimchenko.

**Photo board to the protocol of inspection dated 28 October 2015
in the territory of the National Museum of History of Ukraine in the World War II (Kyiv,
24 Lavrska St., Kyiv, 23 Lavrska St.)**

[Excerpts related to BM-21 Grad only]

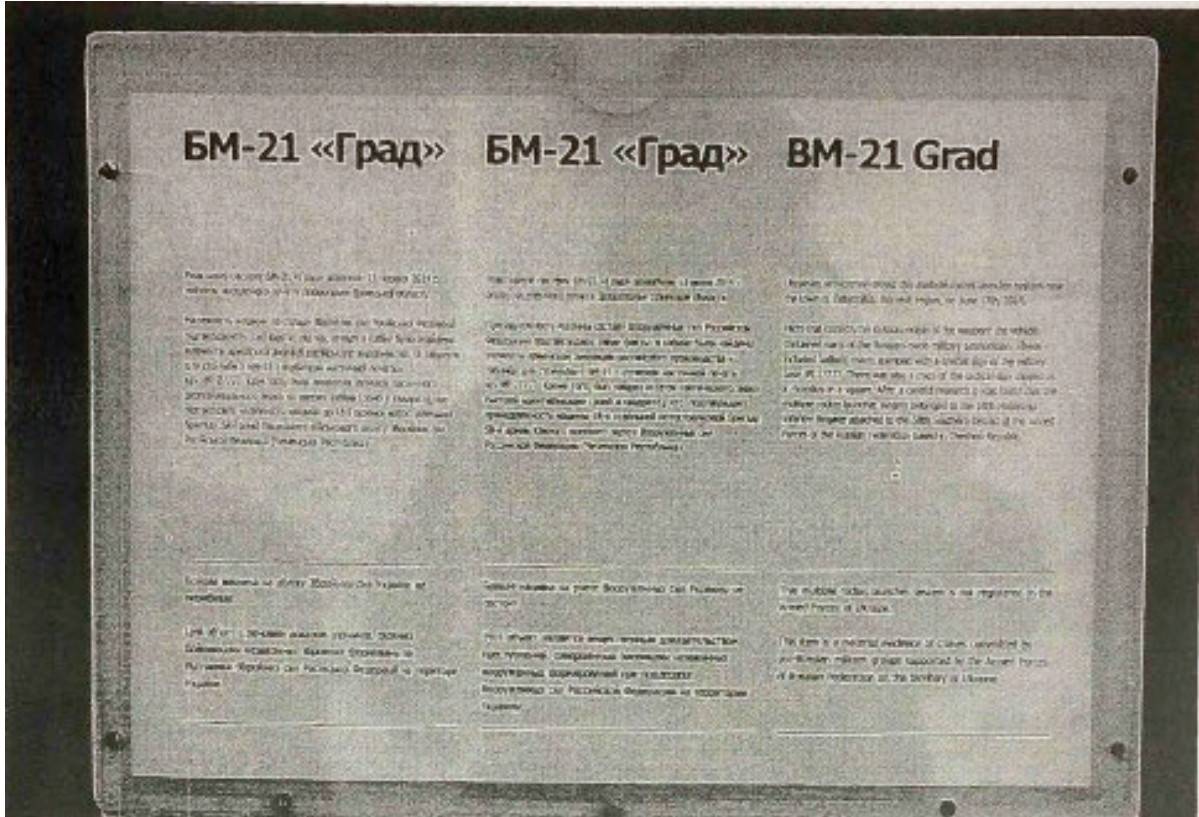

Photo № 7. The information plate on BM-21 “Grad”



Photo № 8. BM-21 “Grad

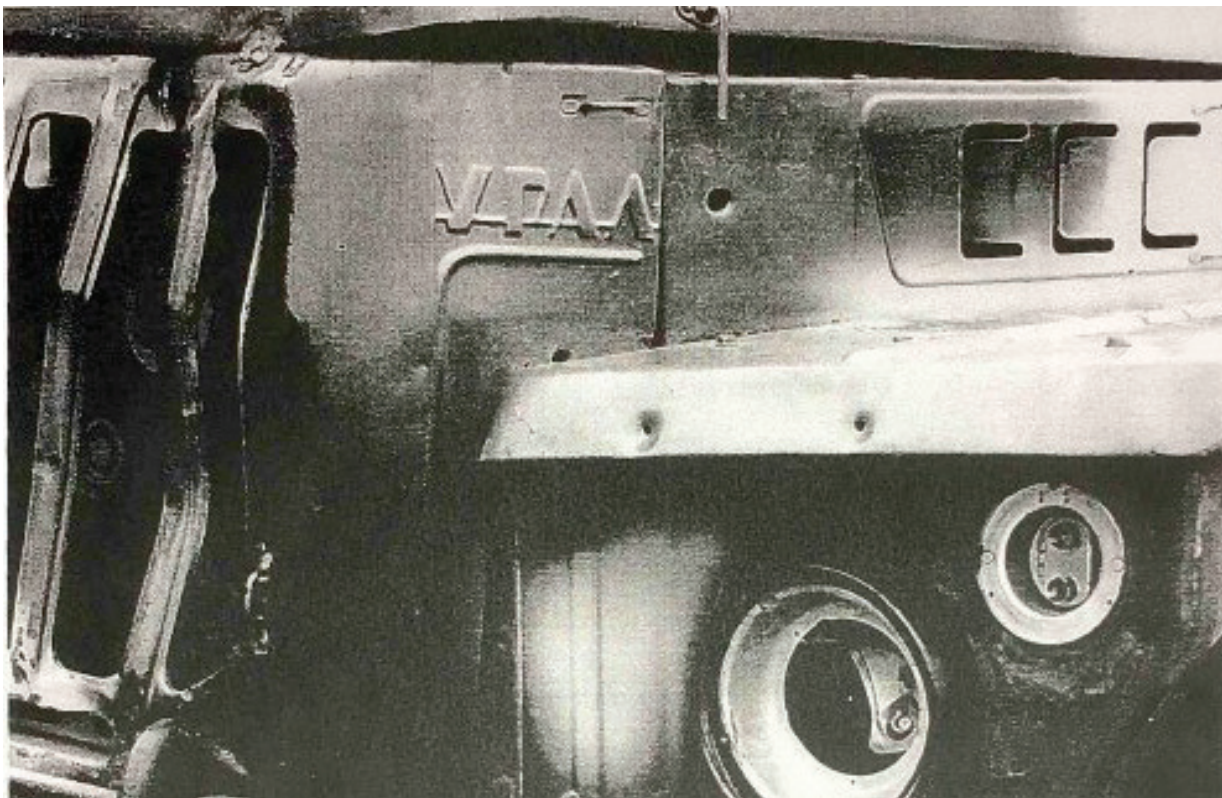

Photo № 9. The appearance of the hood of BM-21 “Grad”

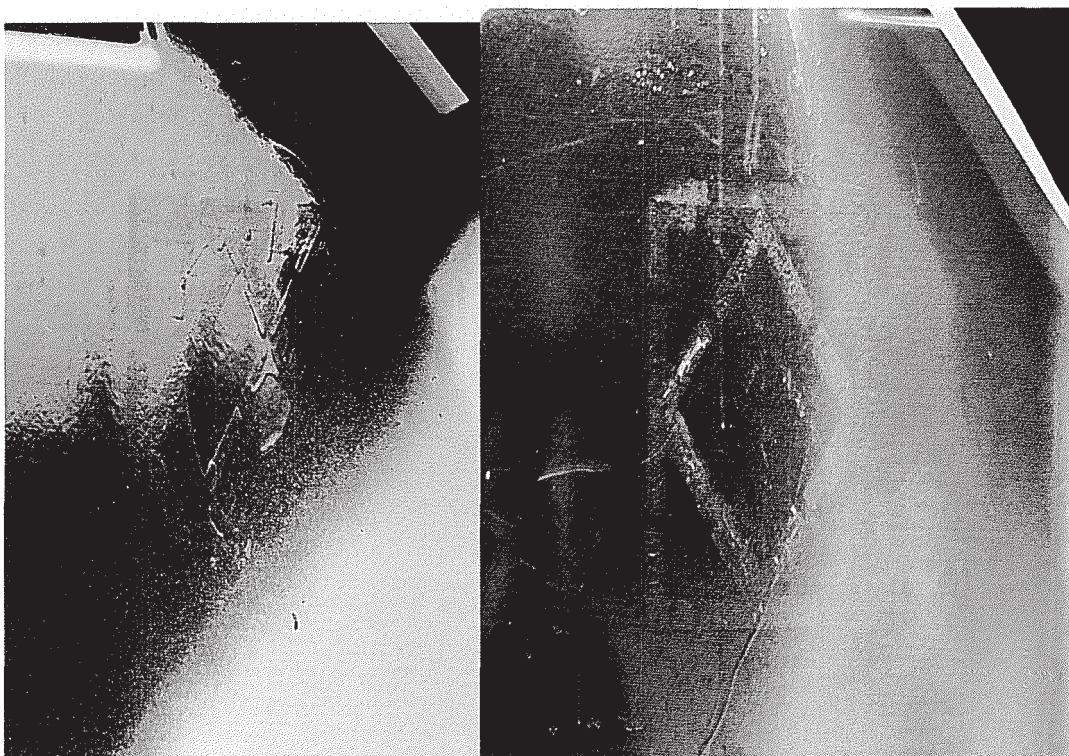

Photo №№ 8,9 The appearance of the right and left doors of BM-21 GRAD

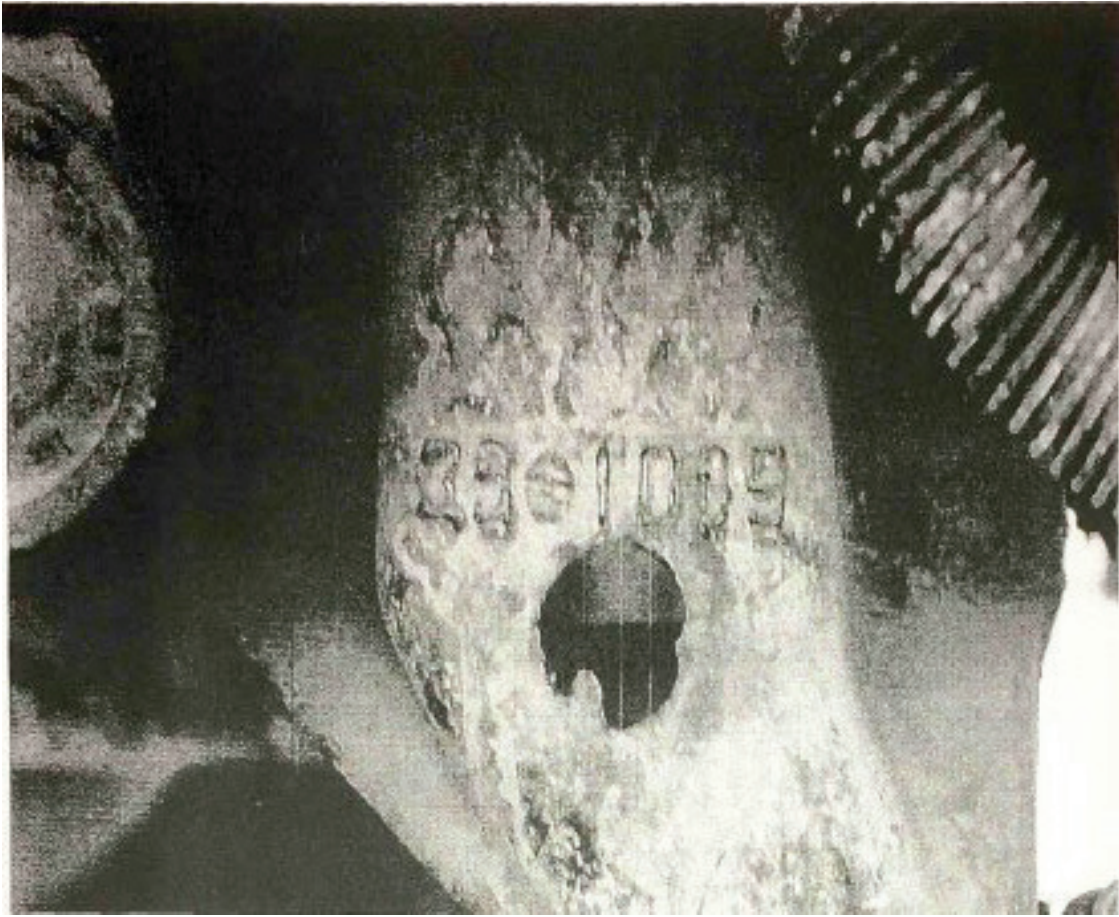

Photo № 10. The number on the running gear of BM-21 GRAD

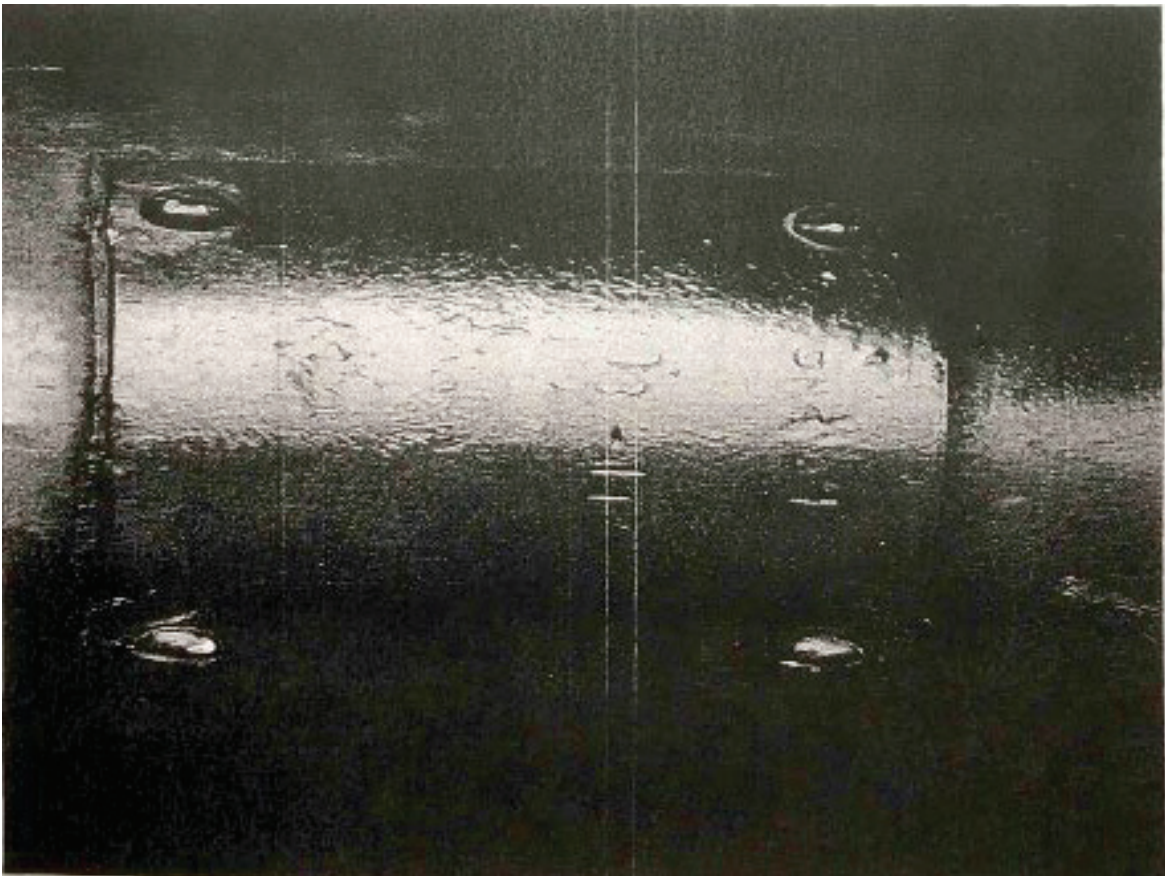

Photo № 11. The number on the launcher of BM-21 GRAD

Annex 137

Smerch Destruction Investigation Report (30 October 2015)

This document has been translated from its original language into English, an official language of the Court, pursuant to Rules of the Court, Article 51.

Pursuant to Rules of the Court Article 51(3), Ukraine has translated only an extract of the original document constituting this Annex. In further compliance with this Rule, Ukraine has provided two certified copies of the full original-language document

EXTRACT

**from the materials of an internal inquiry into the destruction (loss)
of Smerch 9A52 multiple rocket launchers**

Commander of military unit A1546

Report

I hereby report that a fire on October 29, 2015 at the joint rocket artillery stores in Svatovo, where equipment of the 2nd Rocket Artillery Battalion was stored, destroyed four 9T234 and one 9A52-2 and damaged three 9A52-2. Sixteen rocket shells were also destroyed.

I request an internal inquiry into this fact.

10.30.2015

Commander,

Rocket artillery battalion

Lt-Col [signature] S.A. Savchenko

Chief of Staff:

Internal inquiry to be conducted.

Head of commission: M.A. Gudym

Members: Maj A.V. Shulga

Maj V.V.Saponenko

- materials to be sent for approval

by 11.27.16

[signature]

10.30.15

[stamp:] *Ministry of Defense,*

Military Unit 1546

Deputy Chief of Staff for

*- prepare a draft order
on the appointment of
an internal inquiry*

Major [signature]

10.30.2015

This is a true copy

Acting chief of staff, military unit 1546

Maj [signature] V.V. Saponenko

Maj [signature] Korniyenkov

1 82 [illegible]

10.31.2015



MINISTRY OF DEFENSE OF UKRAINE

ORDER

By Military Unit A1546

10.30.2015

Kremenchuk city

No 756

Appointing
an internal inquiry

In accordance with the oral instruction of 10.30.2015 by the commander of rocket and artillery troops, deputy commander of the Ground Troops of the Armed Forces of Ukraine, with the aim of establishing the causes and conditions that led to the loss of arms by the 2nd Rocket Artillery Battalion on 10.29.2015 at the joint rocket and artillery stores in the town of Svatovo, Luhansk Region and establishing the degree of guilt on the part of officials,

I HEREBY ORDER:

1. Appoint an internal inquiry by a commission comprising the following:

Commission chair: myself;

Commission members: senior assistant to the unit's chief of staff, Major V.V. Saponenko; head of the rocket and artillery technical procurement service, Major A.V. Shulga.

2. The commission chair will:

Conduct an internal inquiry by 11.27.2015 with reference to the Ukrainian Armed Forces Disciplinary Charter, the Procedure for Internal Inquiries into State or Local Government Officials approved by Cabinet of Ministers of Ukraine resolution No 950 (amended) of June 13, 2000 and the Instruction on the Procedure for Conducting Inquiries in the Armed Forces of Ukraine approved by Order No 82 of the Minister of Defense of Ukraine on 03.25.2004 registered at the Ministry of Justice of Ukraine as No 385/8984 on March 30, 2004.

This is a true copy

Deputy chief of staff,
First deputy commander of
military unit A1546,
Lieutenant-Colonel
S.M. Yalynny

[stamp:] Ministry of Defense,
Military Unit A1546

3. The implementation of this order will be monitored by me.
4. The order is to be communicated to the unit's personnel as far as it applies to them.

Acting Commander of military unit A1546
Lieutenant-Colonel [signature] M.A. Gudym

Acting chief of staff,
Deputy Commander of military unit A1546,
Major [signature] S.M. Palazhevych

[stamp:] Ministry of Defense,
Military Unit A1546

This is a true copy
Deputy chief of staff,
First deputy commander of
military unit A1546,
Lieutenant-Colonel
S.M. Yalynny

[stamp:] Ministry of Defense,
Military Unit A1546

Reference number	Main account	Correspondent account

APPROVED
Commander, military unit A0105

" " _____ 20____
Stamp goes here

AGREED
Commander, military unit A0120
Colonel [signature] V.V. Atamanyuk
11 [illegible] 2015

AGREED
Head, Sector A
Colonel [signature] V.Y. Myronyuk
" " _____ 2015
Stamp goes here
[stamp:] Anti-terrorist Center,
Security Service of Ukraine

**CERTIFICATE No 407
OF TECHNICAL CONDITION**
BM 9A52 No RGA1307 (MAZ-543M No 1565H5)
(name of arms or equipment)

Information feature	Registration number	Sheet number	Document code	Document number	Document date
00	001	002	003	005	032
	407	1 set	12	407	11.03.2015

Reason (purpose of operation)	Operation code	Operation date	Service (store section)	Military unit (department, store)	Implementation
045	004	034			207
<i>Written off</i>		11.03.2015	<i>Rocket artillery</i>	<i>A1546</i>	<i>Not secret</i>

Debit		Credit		Total	Amortization
Account, subaccount	Analytical accounting code	Account, subaccount	Analytical accounting code		
				2383875.00	<i>Destroyed by fire and explosions at joint stores in Sector A, Svatovo</i>

Viewing the documents has established the following:
1. Composition and qualitative condition

No	Name of arms or equipment (drawing reference no)	Reference No	Unit of measurement	Quantity	Category		Cost		Factory number	Manufacturer	Manual (certificate) number	
					On paper	In fact	initial	residual				
1	2	3	4	5	6	7	8	9	10	11	12	
I	Item 9A52-2, comprising:	075	076	097	079	083	171	2592100.00	2383875.00	007	180	012
-	543M chassis		set	I	II	V				TM4TR0601289	MAZ	ZhA181395
-	Diesel D12A-525A		set	I	II	V				T11KT2511		
-	sights		set	I	II	V				H844		
-	Lower deck mount		set	I	II	V				61		

2. Technical and operational data	
1. Put in service (date)	02.28.1990
2. In service (years, months)	25 years, 8 months
3. Cycles, hours, mileage since put into operation	23569 c, 279.8 mph 4047 km
4. Designed: Capacity (cycles, hours, mileage)	75000 cycles
Service life (years, months)	25 years
Guaranteed service (cycles, hours, mileage)	3000 cycles, 18000 km
Guarantee term	5 years
5. Repairs completed (description, date)	none
6. How long in operation since last repaired	n/a
7. Cycles, hours, mileages since last repaired	n/a
8. Under (over): designed capacity (cycles, hours, mileage)	51431 cycles under capacity
Service life (years, month)	8 months
Guaranteed service (cycles, hours, mileage)	13953 km under guaranteed 20569 cycles over guaranteed
Expiration date	n/a

3. Accessories

The item is supplied with 75% of required accessories, excluding a ZIP which is recorded as not supplied according to undersupply card No 220 of 07.27.2011 on 4 (four) sheets. Tires VI-203 1500 x 600 x 635, quantity 9: No 4889V530112, 4889V530029, 4889V530013, 4889V530218, 4889V530118, 4889V530100, 4889V530299, 4889V530059 and 4889V530179.
Batteries 6ST-190, four, made in 2013.

4. Technical condition

Item 9A52-2, factory no RGA1307 was destroyed on 10.29.2015 as a result fire and explosions at the joint stores of Sector A (Svatovo, Luhansk Region) during the anti-terrorist operation in Donetsk and Luhansk Regions (irretrievable losses).

According to the Instruction on the Classification of Rocket Artillery Arms approved by order No 19 of the Ministry of Defense of Ukraine on 03.11.2013, its technical condition is category V, whereby recovery is impossible and economically unviable.

5. Reasons for early amortization or damage

Item 9A52-2, factory no RGA1307 was destroyed on 10.29.2015 as a result fire and explosions at the joint stores of Sector A (Svatovo, Luhansk Region) during the anti-terrorist operation in Donetsk and Luhansk Regions (irretrievable losses).

6. Extent of completed upgrades
(upgrade bulletin number)

No upgrades were carried out.

7. Write-off calculation

Write-off costs			Write-off receipts			
Document title	Cost code	Amount	Document title	Type of valuables	Quantity	Amount

8. Commission's proposals

Item 9A52-2, factory no RGA1307 was destroyed on 10.29.2015 as a result fire and _____ explosions at the joint stores of Sector A (Svatovo, Luhansk Region) during the anti-terrorist operation in Donetsk and Luhansk Regions (irretrievable losses). According to the _____ Instruction on the Classification of Rocket Artillery Arms approved by order No 19 of the _____ Ministry of Defense of Ukraine on 03.11.2013, its technical condition is category V, _____ whereby recovery is impossible and economically unviable. It is to be put in category V and subsequently written off, pursuant to order 17 by the Ministry of Defense of Ukraine of 01.12.2015.

Commission chair: Lieutenant-Colonel [signature] M.A. Gudym
(military rank, signature, surname and initials)

Commission members: Lieutenant-Colonel [signature] S.A. Savchenko
(military rank, signature, surname and initials)

Major [signature] A.V. Shulga
(military rank, signature, surname and initials)

Major [signature] V.V. Saponenko
(military rank, signature, surname and initials)

Captain [signature] V.V. Gaponyuk
(military rank, signature, surname and initials)

Compiled in 3 copies with photo materials attached on 1 sheet.

Copy No 1: military unit No A 0120

Copy No 2: military unit No A 1546

Copy No 3: _____

9. Conclusion by the military unit commander
(senior manager)

I agree with this conclusion. I am requesting a transfer to category V and subsequent write-off.

Acting Commander of Military Unit No A1546 -

Colonel [signature] S.M. Yalynny

(military rank, signature, surname and initials)

November 2015

[stamp:] Ministry of Defense, Military Unit A1546

(military rank, signature, surname and initials)

(military rank, signature, surname and initials)

” “ _____ 2015

AGREED Senior detective officer, department 7, directorate 5, Main Directorate of Military Counterintelligence, Department of Counterintelligence, Security Service of Ukraine

[signature]

S. Bayer

M 9A52-2 factory No RGA1307 (MAZ-543M No 1565N5), military unit A1546, destroyed in a fire at the joint rocket artillery stores in Sector A, Svatovo, on 10.29.2015.



Extract from combat action log 107 rocket artillery unit inv No r/z 49/29/1

COPY

Date, time	Mission and brief summary of combat action	Notes
1	2	3
10.29.15	<i>Designated personnel of the 107th, 2/107th rocket artillery</i>	
22:00	<i>control points is at the base camp (village of</i>	
	<i>Pershotravneve) undertaking comprehensive</i>	
	<i>safeguarding duties, maintenance (repair) of arms and military</i>	
	<i>equipment and other scheduled activities; no [word illegible]</i>	
	<i>took place for 24 hours. At 19:45 we began to observe flashes</i>	
	<i>in the area of the rocket artillery stores in Svatovo. Personnel</i>	
	<i>took a defensive position and stepped up security. This fact</i>	
	<i>was reported to the headquarters of the anti-terrorist operation</i>	
	<i>and Sector A headquarters. No losses of personnel or</i>	
	<i>equipment occurred in Pershotravneve. No information was</i>	
	<i>received about the state of the equipment kept at the rocket</i>	
	<i>artillery stores, comprising 4 units of 9A52-2 MAZ-543M and</i>	
	<i>4 units of 9T234 MAZ 543A. Communications equipment and</i>	
	<i>the automatic control system are in working order.</i>	
	<i>Senior assistant to the chief of staff of 107th rocket artillery</i>	
	<i>unit</i>	
	<i>Major [signature] V.V. Saponenko</i>	

This is a true copy

Acting commander of military unit No A1546

Lieutenant-Colonel [signature] S.M. Yalynny

[stamp:] Ministry of Defense,

Military Unit A1546

Chief of Staff,

First Deputy Commander of

Military unit No A1546

Lt-Col [signature] S.M. Yalynny

02.12.2016

[stamp:] Ministry of Defense,

Military Unit A1546

Extract from combat action log 107 rocket artillery unit inv No r/z 49/29/1

COPY

Date, time	Mission and brief summary of combat action	Notes
1	2	3
	<i>Continued:</i>	
10.31.2015	<i>Designated personnel of the 107th, 2/107th rocket artillery</i>	
	<i>control point is at the base camp (village of</i>	
	<i>Pershotravneve) undertaking comprehensive</i>	
	<i>safeguarding duties. The acting commander of the rocket</i>	
	<i>artillery regiment and the commander of the 2nd rocket artillery battalion went to</i>	
	<i>the joint rocket artillery stores to</i>	
	<i>ascertain and inspect the equipment stored there and to assess</i>	
	<i>the losses of equipment and related property. The inspection</i>	
	<i>established the following: the fire and ammunition detonation</i>	
	<i>destroyed (irretrievable losses) 4 units of equipment 9T234-2</i>	
	<i>MAZ 543A and 1 unit of 9A52-2 MAZ 543M, as well as the property stored with</i>	
	<i>the equipment, namely: MAZ-543A No 4511 M5, 9 T34-2 RGA 2616; chassis</i>	
	<i>543ATR and TR 1280190; engine D 12A 525A T11 KT 2618; engine D21A1</i>	
	<i>1260 935; radio station R-173 313G003 U 417977, one;</i>	
	<i>9T234 trailer tent, 1 set; set of 15 keys, one;</i>	
	<i>battery 6ST-190 810800, 4; set of wma</i>	
	<i>headstamps, 1; winter diesel fuel 3-0.2 minus 45 0666</i>	
	<i>-590 l; TOCON A-40 0553 cooling fluid – 100 l; MT-16p</i>	
	<i>0192 oil -187 l; MGE-10A 0511 unified hydraulic oil – 132 l;</i>	
	<i>A 0263 transmission oil -109 l; GTZh-22M 0532 brake</i>	
	<i>fluid – 5 l; M6z / 10V 0145 long-term unified all-season oil</i>	
	<i>Set, 7.9 l; KS-10 T1824140U canister, two; KS-20 T1824 135U, four; Forest</i>	
	<i>camouflage set, one; mine clearing shovel B24</i>	
	<i>96000U, 2; infantry shovel B2494000U, 3; carpenter axe</i>	
	<i>B2497000U, 1; pickaxe, large, B2499000U, 1; OP-1</i>	
	<i>protective coat D1120005U, 2; protection knee-high socks</i>	
	<i>D11 20030U, 2 pairs; bag for protective socks and gloves</i>	
	<i>D11 20030U, 2; BL-1M D1120020U gloves, 2 pairs; PMK</i>	
	<i>gas mask D1111010U, two; DK-4 KD(D) D1520085U set, 2;</i>	
	<i>aluminum pan, 2; enameled bowl, 2; aluminum spoon, 2;</i>	
	<i>ANDU tent, 1 set; sleeping bag, 2; duffel bag, 2;</i>	
	<i>aluminum flask with sheath, 2; army shelter poncho; foam</i>	
	<i>mat, 2; waterproof suit, 2; thermal camouflage trousers, 2</i>	
	<i>pairs; rubber boots, 1 pair.</i>	
	<i>At TZM 9T234 MAZ-543A RG8055T No 4517 M5; chassis</i>	
	<i>TA5DB 9051089, engine D12A-525A TOO TT2280, engine</i>	
	<i>D21A1 1211 932; radio station DP4400 311176, one; radio</i>	
	<i>station R-173 V13G 0003U 417977, one set; 9T234 trailer</i>	
	<i>tent, one set; battery 6ST-190 810800, 4; set of 15 keys, one; set of wma</i>	

This is a true copy

Acting commander of military unit No A1546

Lieutenant-Colonel [signature] S.M. Yalynny

[stamp:] Ministry of Defense,

Military Unit A1546

Chief of Staff,

First Deputy Commander of

Military unit No A1546

Lt-Col [signature] S.M. Yalynny

02.12.2016

[stamp:] Ministry of Defense,

Military Unit A1546

Extract from combat action log 107 rocket artillery unit inv No r/z 49/29/1

COPY

Date, time	Mission and brief summary of combat action	Notes
1	2	3
	<i>Continued:</i>	
	<i>headstamps, 1; winter diesel fuel 3-0.2 minus 45 0666</i>	
	<i>-590 l; TOCON A-40 0553 cooling fluid – 100 l; MT-16p</i>	
	<i>0192 oil -187 l; MGE-10A 0511 unified hydraulic oil – 132 l;</i>	
	<i>A 0263 transmission oil -109 l; GTZh-22M 0532 brake</i>	
	<i>fluid – 5 l; M6z /10V 0145 long-term unified all-season oil</i>	
	<i>set; – 7.9 l; KS-10 T1824140U canister, two; KS-20 T1824</i>	
	<i>135U, four; Forest camouflage set, one; mine clearing shovel B24</i>	
	<i>96000U, 2; infantry shovel B2494000U, 3; carpenter axe</i>	
	<i>B2497000U, 1; pickaxe, large, B2499000U, one; OP-1</i>	
	<i>protective coat D1120005U, 2; protection knee-high socks</i>	
	<i>D11 20030U, 2 pairs; bag for protective socks and gloves</i>	
	<i>D11 20030U, 2; BL-1M D1120020U gloves, 2 pairs; PMK</i>	
	<i>gas mask D1111010U, two; DK-4 KD(D) D1520085U set, 2;</i>	
	<i>aluminum pan, 2; enameled bowl, 2; aluminum spoon, 2;</i>	
	<i>ANDU tent, 1 set; sleeping bag, 2.</i>	
	<i>At TZM 9T234 MAZ-543A RGA2619 No 1530 M5; chassis</i>	
	<i>TA9TR 2390 290, engine D12A-525A ZhO 2KT5772, engine</i>	
	<i>D21A1 1269108; radio station DP4400 No 431085, one;</i>	
	<i>9T234 trailer</i>	
	<i>tent, one set; battery 6ST-190 810800, 4; set of 15 keys, one; professional tool</i>	
	<i>box, 26 ½ pieces, one set;</i>	
	<i>winter diesel fuel 3-0.2 minus 45 0666</i>	
	<i>-590 l; TOCON A-40 0553 cooling fluid – 100 l; MT-16p</i>	
	<i>0192 oil -187 l; MGE-10A 0511 unified hydraulic oil – 132 l;</i>	
	<i>A 0263 transmission oil -109 l; GTZh 22M 0532 brake</i>	
	<i>fluid – 5 l; M6z / 10V 0145 long-term unified all-season oil</i>	
	<i>set; – 7.9 l; KS-10 T1824140U canister, two; KS-20 T1824</i>	
	<i>135U, four; Forest camouflage set, one; mine clearing shovel B24</i>	
	<i>96000U, 2; infantry shovel B2494000U, 3; carpenter axe</i>	
	<i>B2497000U, 1; pickaxe, large, B2499000U, one; OP-1</i>	
	<i>protective coat D1120005U, 2; protection knee-high socks</i>	
	<i>D11 20030U, 3 pairs; bag for protective socks and gloves</i>	
	<i>D11 20030U, 2; BL-1M D1120020U gloves, 3 pairs; PMK</i>	
	<i>gas mask D1111010U, three; DK-4 KD(D) D1520085U set, 2;</i>	
	<i>aluminum pan, 3; enameled bowl, 3; aluminum spoon, 2;</i>	
	<i>ANDU tent, 1 set; sleeping bag, 2; duffel bag, 3; foam mat, 3.</i>	
	<i>At TZM 9T234 MAZ-543A RGA 2616 No 4501 M5; chassis</i>	
	<i>TA2TR 0821289, engine D12A-525A T11KT2575, engine</i>	
	<i>D21A1 1248475; radio</i>	
	<i>station R-173 V13G 0003U 417977, one set; TK-2 V19A3006U coil, two; P274M</i>	
	<i>field cable V1866003U, 1000 m; field telephone set TA-57 V 1866003U, one;</i>	
	<i>9T234 trailer tent, one set; battery 6ST-190 810800, four; set of 15</i>	

This is a true copy

Acting commander of military unit No A1546

Lieutenant-Colonel [signature] S.M. Yalynny

[stamp:] Ministry of Defense,

Military Unit A1546

Chief of Staff,

First Deputy Commander of

Military unit No A1546

Lt-Col [signature]

S.M. Yalynny

02.12.2016

[stamp:] Ministry of Defense,

Military Unit A1546

Extract from combat action log 107 rocket artillery unit inv No r/z 49/29/1

COPY

Date, time	Mission and brief summary of combat action	Notes
1	2	3
	<i>Continued:</i>	
	<i>keys, one; professional tool box, 26 ½ pieces, one set;</i>	
	<i>winter diesel fuel 3-0.2 minus 45 0666</i>	
	<i>-590 l; TOCON A-40 0553 cooling fluid – 100 l; MT-16p</i>	
	<i>0192 oil -187 l; MGE-10A 0511 unified hydraulic oil – 132 l;</i>	
	<i>A 0263 transmission oil -109 l; GTZh-22M 0532 brake</i>	
	<i>fluid – 5 l; M6z /10V 0145 long-term unified all-season oil</i>	
	<i>set; – 7.9 l; KS-10 T1824140U canister, two; KS-20 T1824</i>	
	<i>135U, four; Forest camouflage set, one; mine clearing shovel B24</i>	
	<i>96000U, 2; infantry shovel B2494000U, 3; carpenter axe</i>	
	<i>B2497000U, 1; pickaxe, large, B2499000U, one; OP-1</i>	
	<i>protective coat D1120005U, 3; protection knee-high socks</i>	
	<i>D11 20030U, 3 pairs; bag for protective socks and gloves</i>	
	<i>D11 20030U, 3; BL-1M D1120020U gloves, 3 pairs; PMK</i>	
	<i>gas mask D1111010U, three; DK-4 KD(D) D1520085U set, 2;</i>	
	<i>aluminum pan, 3; enameled bowl, 3; aluminum spoon, 3;</i>	
	<i>ANDU tent, 1 set; sleeping bag, 3; duffel bag, 3; army shelter poncho, 3; foam</i>	
	<i>mat, 2; Corsar M3 -1 -4 plated vest, three;</i>	
	<i>At BM 9A52-2 RGA 1307 MAZ 543M No 1565M5, chassis</i>	
	<i>TM4 TR 0603289; radio station DM 3600 VHF</i>	
	<i>038TNN4818, one; mobile antenna with additional</i>	
	<i>equipment for mounting armored vehicle radio station, one;</i>	
	<i>TK-2 V19A3006U coil, three; P274M field cable V1866 003U, 1500 m; field</i>	
	<i>telephone set TA-57 V 1866003U, one;</i>	
	<i>ZIP for R-173 ShI 1.101 027 TU, one set; 9A52 trailer tent, one set; PAB-2M</i>	
	<i>boussole, set 02A318, one; PAB-2M boussole, set 9G716, one; Adrianov</i>	
	<i>compass, one; curvimeter, one; calipers, one set; SOS stopwatch PR-26-2-000,</i>	
	<i>one; box for batteries; NK-13 batteries, four; electricity meter C 4353, tripod for</i>	
	<i>K-1 with cover, one; 12 t jack, one; control level P-S GOST 3059-75, one; launch</i>	
	<i>key 9B 370 M. SB. D 0-10, two; ZIP for item 9A52-2 (as per accessory list), one;</i>	
	<i>docking device 9A52.22.370 No 19; battery 6ST-190 810800, four; VKK Z5</i>	
	<i>929230 fire extinguisher, one; set of 15</i>	
	<i>keys, one; professional tool box, 26 ½ pieces, one set; TSh-001 L helmet phone,</i>	
	<i>summer, two; TSh-001 Z helmet phone, winter, two; non-mechanized lug wrench</i>	
	<i>with drive parts, set model 233BM1, one set; 25 t jack, one;</i>	
	<i>winter diesel fuel 3-0.2 minus 45 0666</i>	
	<i>-700 l; TOCON A-40 0553 cooling fluid – 102.5 l; MT-16p</i>	
	<i>0192 oil -187 l; MGE-10A 0511 unified hydraulic oil – 40 l;</i>	
	<i>A 0263 transmission oil -109 l; GTZh-22M 0532 brake</i>	
	<i>fluid – 5 l;</i>	
	<i>KS-10 T1824140U canister, five; KS-20 T1824</i>	

This is a true copy

Acting commander of military unit No A1546

Lieutenant-Colonel [signature] S.M. Yalynny

[stamp:] Ministry of Defense,

Military Unit A1546

Chief of Staff,

First Deputy Commander of

Military unit No A1546

Lt-Col [signature] S.M. Yalynny

02.12.2016

[stamp:] Ministry of Defense,

Military Unit A1546

Extract from combat action log 107 rocket artillery unit inv No r/z 49/29/1

COPY

Date, time	Mission and brief summary of combat action	Notes
1	2	3
	<i>Continued:</i>	
	<i>135U, three; navigation equipment for satellite navigation system users SN-3003M "Basalt" without battery or receiver D411 0056U Ya 51 60156, one; Steppe camouflage set, one; mine clearing shovel B24</i>	
	<i>96000U, four; infantry shovel B2494000U, 3; B249 8000U transverse pick, one; sledgehammer, one; [two words illegible] B249A000U, one; carpenter axe B2497000U, four; pickaxe, large, B2499000U, one; OP-1</i>	
	<i>protective coat D1120005U, four; protection knee-high socks</i>	
	<i>D11 20030U, 4 pairs; bag for protective socks and gloves</i>	
	<i>D11 20030U, 4; BL-1M D1120020U gloves, 4 pairs; PMK</i>	
	<i>gas mask D1111010U, four; DK-4 KD(D) D1520085U set, 2;</i>	
	<i>aluminum pan, 3; enameled bowl, 3; aluminum spoon, 3;</i>	
	<i>ANDU tent, 1 set; duffel bag, 3; tactical vest, three; aluminum flask with sheath, three; army shelter poncho, three; foam mat, four; Canada jacket, two; Canada trousers, two; Canada combat boots, 1 pair.</i>	
	<i>The rest of the equipment sustained damage to various</i>	
	<i>degree (9A52-2 RGA 1318, MAZ-543M No 1572M5, 9A52-</i>	
	<i>2 RGA 1321 MAZ-543M No 1563M5, 9A RGA 1322 MAZ-</i>	
	<i>543M No 1564 M5). The damaged and destroyed equipment</i>	
	<i>was left at the Sector A rocket and artillery store in Svatovo,</i>	
	<i>as there is no evacuation access due to the nature of location.</i>	
	<i>At 17:00 we received instruction No4 / 9583 og/esc of</i>	
	<i>10.31.15 from the anti- terrorist headquarters in Donetsk</i>	
	<i>and Luhansk Regions to send one 9 T234 unit form the store</i>	
	<i>of the 1st rocket artillery battalion to facilitate evacuation</i>	
	<i>and to unload the damaged vehicles of the 2nd rocket artillery</i>	
	<i>battalion; on the same day the 9 T234 arrived at base camp</i>	
	<i>in Pershotravneve. Irrecoverable ammunition losses amounted</i>	
	<i>to 16 rocket shells. Twelve rocket shells remained loaded</i>	
	<i>onto one 9A52-2 unit No 1563M5 RGA 1321. The extent of</i>	
	<i>damage will be established after the equipment is evacuated</i>	
	<i>and unloaded. No personnel or equipment losses were</i>	
	<i>sustained at base camp. No sabotage activity or signs of</i>	
	<i>enemy reconnaissance were observed. Communications and</i>	
	<i>automatic troop management systems are in working</i>	
	<i>order.</i>	
	<i>Senior assistant to chief of staff,</i>	
	<i>Rocket and artillery regiment 107</i>	
	<i>Major [signature] V.V. Saponenko</i>	

This is a true copy

Acting commander of military unit No A1546

Lieutenant-Colonel [signature] S.M. Yalynny

[stamp:] Ministry of Defense,

Military Unit A1546

Chief of Staff,

First Deputy Commander of

Military unit No A1546

Lt-Col [signature] S.M. Yalynny

02.12.2016

[stamp:] Ministry of Defense,

Military Unit A1546

Extract from combat action log 107 rocket artillery unit inv No r/z 49/29/1

COPY

Date, time	Mission and brief summary of combat action	Notes
1	2	3
11.05.15	<i>Designated personnel of the 107, 2/107 rocket artillery</i>	
22:00	<i>control point are at the base camp (village of</i>	
	<i>Pershotravneve) undertaking comprehensive safeguarding</i>	
	<i>duties and arms and equipment maintenance on the damaged</i>	
	<i>Sector A vehicles (three 9A52-2units) at the assembly</i>	
	<i>station. Assessment was carried out of the damaged property</i>	
	<i>stored on board the vehicles evacuated from the rocket and</i>	
	<i>artillery stores in Sector A. At 9A52-2 RGA 1322 MAZ 543</i>	
	<i>No 1564 M5, chassis TM1TR2910390: trailer tent for 9A52-2</i>	
	<i>one; Steppe camouflage set, one; tires 1500 x 600 x 635</i>	
	<i>3999B 530022, one set; driver cabin windscreen, one; curtain</i>	
	<i>for driver's cabin, one; rear view mirrors, 2;</i>	
	<i>At 9A52-2 RGA 1321 MAZ 543 No 1563M5, chassis</i>	
	<i>TM2TR0321289: trailer tent for 9A52-2, one;</i>	
	<i>Steppe camouflage set, one; duffel bag, one; aluminum pan,</i>	
	<i>Three; enameled bowl 3; aluminum spoon, 3; army shelter</i>	
	<i>poncho, one; foam mat, one; waterproof suit, 3; winter diesel</i>	
	<i>Fuel 3-0.2 minus 45 0666 – 350 l;</i>	
	<i>TOCON A-40 0553 cooling fluid – 102.5 l; MT-16p</i>	
	<i>0192 oil - 48 l; MGE-10A 0511 unified hydraulic oil – 40 l;</i>	
	<i>GTZh-22M 0532 brake</i>	
	<i>fluid – 5 l; mine clearing shovel B24</i>	
	<i>96000U, one; sledgehammer, 1; carpenter axe</i>	
	<i>B2497000U, 4; pickaxe, large, B2499000U, 1;</i>	
	<i>TK-2 V19A3006U coil, one; P274M field cable V1866003U, 500 m; TSh-1 L</i>	
	<i>helmet phone, summer, two; TSh-001Z helmet phone, winter, two; KS-20 T1824</i>	
	<i>135U, two; imaging</i>	
	<i>guide protector SB 16340, two; external view mirror, two;</i>	
	<i>[word illegible] ZIP to item 9A52-2 (as per accessory list).</i>	
	<i>At 12:00 we received a verbal instruction from the head of</i>	
	<i>the rocket artillery department of the anti-terrorist</i>	
	<i>Headquarters, Col V.M. Gistsev. The instruction was</i>	
	<i>communicated to KD 1,2 of the 3rd combined rocket artillery</i>	
	<i>battery 3/107. (Implementation commenced). Rocket artillery</i>	
	<i>battalion 1/107, combined rocket artillery battery 3/107</i>	
	<i>reported on the unloading of armored vehicles located in</i>	
	<i>the designated areas. No strikes were delivered.</i>	
	<i>No sabotage activity or signs of</i>	
	<i>enemy reconnaissance were observed. No personnel, arms or equipment losses</i>	
	<i>were sustained (apart from those considered irretrievably lost). Communications</i>	
	<i>and</i>	
	<i>automatic troop management systems are in working</i>	
	<i>order.</i>	
	<i>Senior assistant to chief of staff,</i>	
	<i>Rocket and artillery unit 107</i>	
	<i>Major [signature] V.V. Saponenko</i>	

This is a true copy

Acting commander of military unit No A1546

Lieutenant-Colonel [signature] S.M. Yalynny

[stamp:] Ministry of Defense,

Military Unit A1546

Chief of Staff,

First Deputy Commander of Military unit No A1546

Lt-Col [signature]

S.M. Yalynny

02.12.2016

[stamp:] Ministry of Defense,

Military Unit A1546

Total case papers numbered, bound and sealed

with wax seal "For Packages": 16 sheets

Lieutenant-Colonel [signature] S.A. Dmytruk

[seal:] Military Unit [number not visible]
FOR PACKAGES

Annex 138

Ukraine Executive Committee of the Kramatorsk City Council Letter No. F1-28/4812
to Investigations Department of the Donetsk Regional Directorate of the SSU (12
November 2015)

This document has been translated from its original language into English, an official
language of the Court, pursuant to Rules of the Court, Article 51.

Pursuant to Rules of the Court Article 51(3), Ukraine has translated only
an extract of the original document constituting this Annex. In further
compliance with this Rule, Ukraine has provided two certified copies of the
full original-language document



UKRAINE

EXECUTIVE COMMITTEE OF THE KRAMATORSK CITY COUNCIL

2 pl. Lenina, Kramatorsk, Donetsk Region 84313. Tel. (0626) 48-54-88, 48-54-91
 Fax (0626)48-55-01. Email: obshotd@gov.krm.dn.ua Website: www.krm.dn.ua

12/11/2015 No. F1-28/4812

Your ref. No. 56/13/3-139 nt dated 11/26/2015

Lieutenant of Justice 1st Class S.S. Kovalyov
 Senior Investigator, 3rd Section of the
 Investigations Department at the Donetsk
 Regional Directorate of the SBU

(deployed to Kramatorsk)

The Executive Committee of the Kramatorsk City Council has reviewed your letter No. 56/13/3-139 nt of 11/26/2015 and hereby informs you of the following:

During the artillery shelling of the city of Kramatorsk on February 10, 2015, the following residential buildings were damaged:

42 vul. Dvirtseva;
 58 vul. Parkova, floors 4-6;
 56 vul. Dvirtseva;
 58 vul. Dvirtseva;
 11 b. Kramatorskyy;
 13 b. Kramatorskyy;
 99 vul. Parkova;
 107 vul. Parkova;
 24 vul. Lenina;
 34 vul. Lenina;
 13 vul. Marata;
 14 vul. Marata;
 17 vul. Marata;
 24 vul. 19 Partzyizdu;
 105 vul. Parkova.

As well as the following social facilities:
 Kindergarten No. 88, 23 b. Kramatorskyy;
 Art School, 15 vul. Marata;
 City Hospital No. 3.

By Order No. 86-r of the Cabinet of Ministers of Ukraine dated 02/12/2015, the Donetsk Regional State Administration was allocated UAH 5 million from the state budget for recovery efforts following the disaster that occurred on February 10, 2015 in the city of Kramatorsk and the provision of assistance to the victims and the families of those who were killed.

In order to resolve the procedures for the receipt and disbursement of funds, the mayor issued Order No. 10 of 02/13/2015, setting up a task force to implement measures associated with recovery efforts following the disaster that occurred in Kramatorsk on 02/10/2015 and the provision of assistance to the victims and the families of those who were killed.

Based on the task force's work and data obtained from local medical facilities and damage reports, information was identified and provided in a timely manner (on 02/16/2015) regarding the allocation of funds for measures associated with the disaster recovery

229

efforts (UAH 3,295,000 for major repairs of damaged infrastructure facilities) and the provision of assistance to the victims and the families of those who were killed (UAH 1,705,000).

Repair work was carried out on buildings, residential housing, and social infrastructure facilities that were damaged as a result of the artillery shelling.

Since the originals of the necessary documents contain a large number of pages, you may review them and make copies at the expense of the Donetsk Regional Directorate of the Security Service of Ukraine.

Mayor

[signature]

A.V. Pankov

Honcharenko 59552

Annex 139

Expert Opinion No. 8713/8714, Professor Emeritus M.S. Bokarius Kharkiv Scientific Research Institute of Forensic Expert Examinations of the Ministry of Justice of Ukraine (23 November 2015)

This document has been translated from its original language into English, an official language of the Court, pursuant to Rules of the Court, Article 51.

Pursuant to Rules of the Court Article 51(3), Ukraine has translated only an extract of the original document constituting this Annex. In further compliance with this Rule, Ukraine has provided two certified copies of the full original-language document



MINISTRY OF JUSTICE OF UKRAINE
PROF. EMERITUS M.S. BOKARIUS KHARKIV
SCIENTIFIC RESEARCH INSTITUTE OF FORENSIC EXPERT
EXAMINATIONS

8-a vul. Zolochivska, Kharkiv, 61177, tel. (057) 372-12-20, tel./fax (057) 372-20-01,

Email: hniise@hniise.gov.ua, Web: <http://hniise.gov.ua>

Unified State Register of Enterprises and Organizations of Ukraine code 02883133

OPINION No. 8713/8714

of an integrated forensic demolitions expert examination of explosives and the products of explosions
and firing

in Criminal Proceeding No. 42014160690000073

Kharkiv

11/23/2015

INTRODUCTION

On 9/4/2015, the Prof. Emeritus M.S. Bokarius Kharkiv Scientific Research Institute of Forensic Expert Examinations received from the Investigations Department of the Office for the Supervision of Legal Compliance by the United Forces of the Anti-Terrorist Operation at the Main Military Prosecutor General's Office of Ukraine, accompanied by cover letter No.10/4/3-2669/vykh.-15 dated 8/11/2015, the order dated 8/11/2015 from senior investigator O.S. Bannyk on commissioning an integrated criminalistic expert examination.

The following were submitted for examination: copies of the criminal case files in a single volume consisting of 98 pages; a polymer bag with fragments recovered during the inspection of incident site on 2/11/2015 on the territory of the Sarmat camping ground; a polymer bag with fragments recovered on 2/10/2015 from the incident site near military unit A3546; a polymer bag with cylindrical objects recovered during the inspection of the incident site on 2/10/2015.

The expert panel was asked to answer the following questions:

“1. Do the fragments (pieces and cylindrical object) recovered from the incident site on February 11, 2015, belong to any munitions; and if so, which ones exactly?

2. Do the objects (fragments and cylindrical objects) recovered from the incident site bear any traces of explosives or explosion products?

3. Did the pieces of the object recovered from the incident site previously form a single whole?

4. Do the explosives found on the recovered objects belong to any particular type (group)?

5. If the objects (fragments) recovered during the inspection of the incident site are fragments of munitions, then from what type of weapon were they fired?”

The expert examination was assigned to the following panel of experts:

- forensic expert and senior research fellow at the laboratory of trace examination, ballistic and explosive examinations and technical examinations of documents Viktor Veniaminovich Somov, who has a higher technical education and is qualified as a forensic expert with specialization 5.2 “Examining explosive devices, traces, and the circumstances of explosions” (certificate No. 348 issued on 12/11/2012 by the Expert Qualification Commission of the Kharkiv Scientific Research Institute of Forensic Expert Examinations, valid until 12/11/2017), forensic expert 1st class with experience working as an expert since 1996 – chairman of the panel;

- forensic expert at the laboratory of physical, chemical and biological examinations Olha Mykhailivna Pashkova, who has a higher technical education and is qualified as a forensic expert with specialization 5.1 “Examining explosives, explosion products, and firing” (certificate No. 767 issued on 12/29/2014) by the Expert Qualification Commission of the Kharkiv Scientific Research Institute of Forensic Expert Examinations, valid until 12/29/2019), forensic expert 4th class with experience working as an expert since 2007.

Pursuant to the requirements of Articles 70(2) and (102) of the Criminal Procedure Code of Ukraine, the experts were warned of the potential liability for knowingly presenting false findings and for refusing without a valid reason to perform their obligations under Articles 384 and 385 of the Criminal Code of Ukraine.

_____ [signature] V.V. Somov

[signature]_____ O.M. Pashkova

Expert V.V. Somov answered question Nos. 1, 3 and 5, while expert O.M. Pashkova answered question Nos. 2 and 4.

Pursuant to section 4.14 of the “Instructions on Commissioning and Conducting Forensic Expert Reviews and Expert Examinations,” approved by Order No. 53/5 of the Ministry of Justice of Ukraine on 10/8/98 (as amended), question Nos. 2 and 4 were combined.

On 9/18/2015 a petition was sent to the investigator with cover letter No. 2/3049eks.

For 45 calendar days, no response to the petition has been received, and the petition has not been granted.

The objects for examination were received in packaged form, in three polymer bags. The bags have been numbered by the experts from 1 to 3.

The fragments recovered during the inspection of the incident site on 2/11/2015 on the territory of the Sarmat camping ground were packed in polymer bag No. 1 (file), the opening of which was tied with a thread. Attached to the ends of the thread was a label with the contact details of the Office for the Supervision of Legal Compliance by the United Forces of the Anti-Terrorist Operation at the Main Military Prosecutor General’s Office of Ukraine and an explanatory note signed by the head of the investigations department and bearing the department’s seal.

The fragments found on 2/10/2015 at the incident site near military unit No. A3546 were packed in polymer bag No. 2 (file), the opening of which was tied with a thread. Attached to the ends of the thread [text cut off].

[text cut off] with the seal of the Office for the Supervision of Legal Compliance by the United Forces of the Anti-Terrorist Operation at the Main Military Prosecutor General's Office of Ukraine.

The cylindrical objects recovered during the inspection of the incident site on 2/10/2015 were packed in polymer bag No. 3, wrapped with transparent adhesive tape. Under the tape was a label with the contact details of the Office for the Supervision of Legal Compliance by the United Forces of the Anti-Terrorist Operation at the Main Military Prosecutor General's Office of Ukraine and an explanatory note signed by the investigator.

The general appearance of the packs is shown in graphs 1–3.

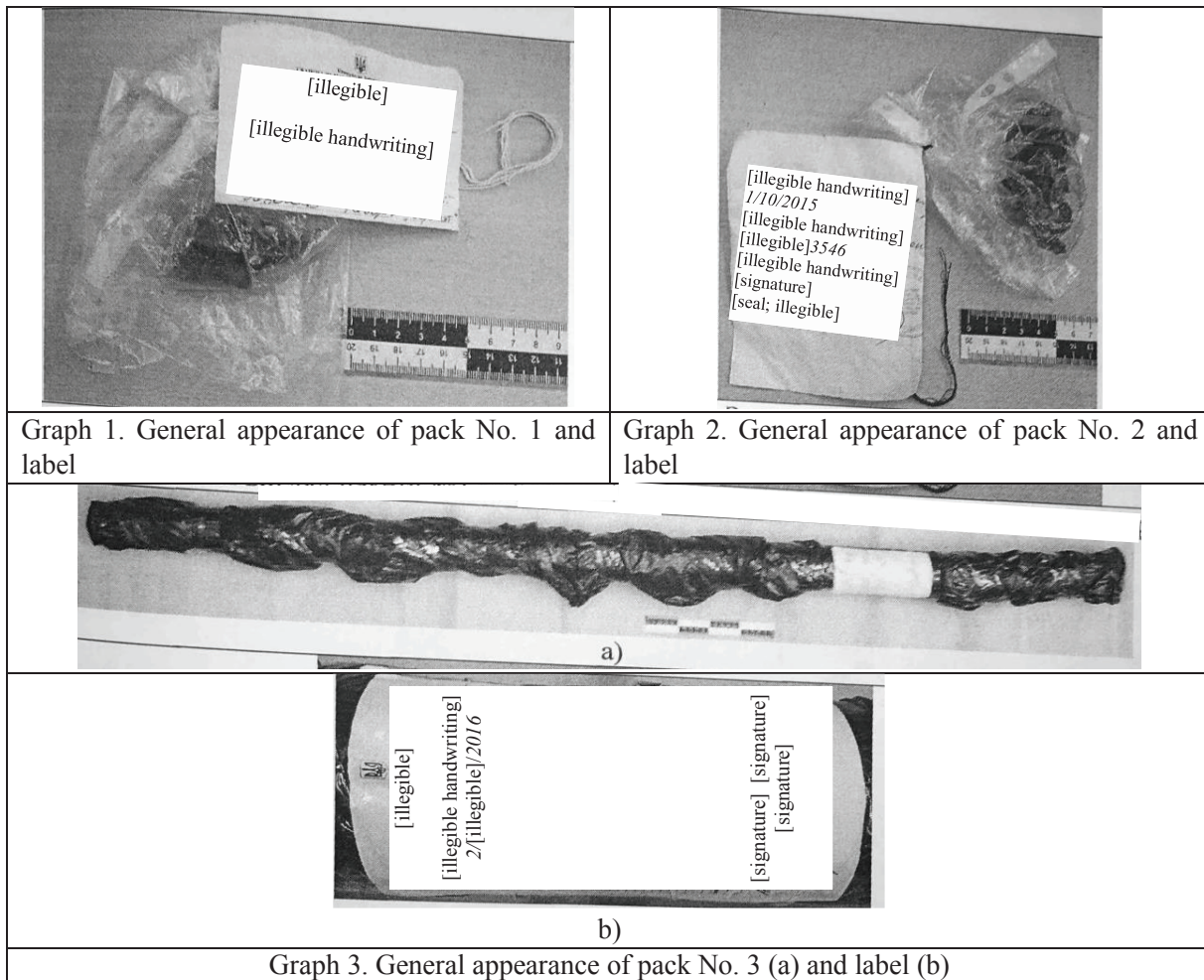

The integrity of the packs had not been breached. The submitted objects match the list of objects indicated in the order.

The following were used in conducting the examination:

1. Methods of examining trace amounts of explosives using thin-layer chromatography and UV spectroscopy, registration code 5.1.05
2. V.N. Aginskiy, Yu.M. Dildin. "Examining Substances to Determine Whether They Are Explosives or Pyrotechnic Components." Central Scientific Research and Criminalistics Laboratory of the Ministry of Internal Affairs of the USSR, Moscow 1982.
3. Methods of integrated examination of explosive devices, explosive substances, and explosion traces, registration code 0.1.12.

EXAMINATION

The examination was conducted under natural (daytime) light by the naked eye and under an MBS-2 microscope with 4.5–16 x magnification. Linear measurements were taken using a caliper ShchTs[text cut off] GOST 166-89 No. 811335. Weighing was done on electric scales SVA-[text cut off] 0.02 Certus Balance. Photographs were taken with an Olympus FE-100 digital camera, 4.0 megapixel in automatic photography mode.

External appearance of the objects
(experts V.V. Somov and O.M. Pashkova)

Upon being opened, pack No. 1 was found to contain objects with the general appearance shown in Graph 4.

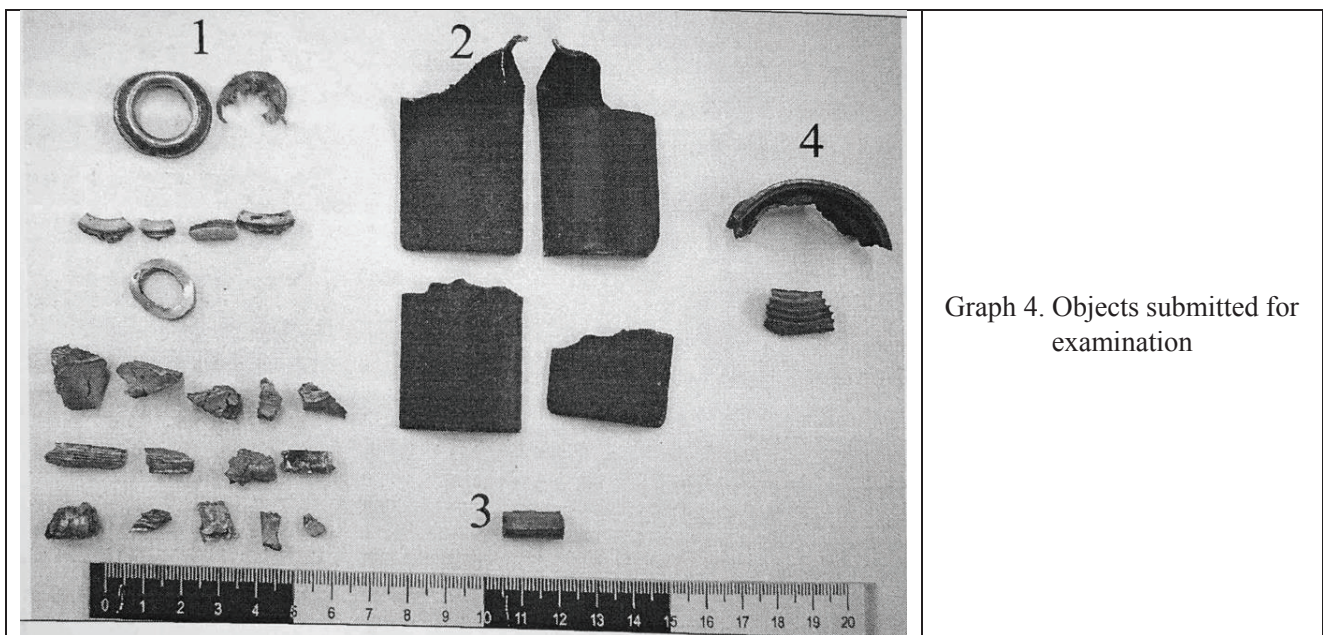

The examination of the objects established that they are fragments of metal and polymer material. The fragments have different metal thicknesses, different magnetizability, traces of technological processing, and layers of paint. Based on these criteria, they were combined into relevant groups, which were numbered 1–4.

The surfaces of the objects have a layer of a black substance that appears to be soot. For further chemical analysis, these objects were designated as **object No. 1**.

Upon being opened, pack No. 2 was found to contain objects with the general appearance shown in Graph 5.

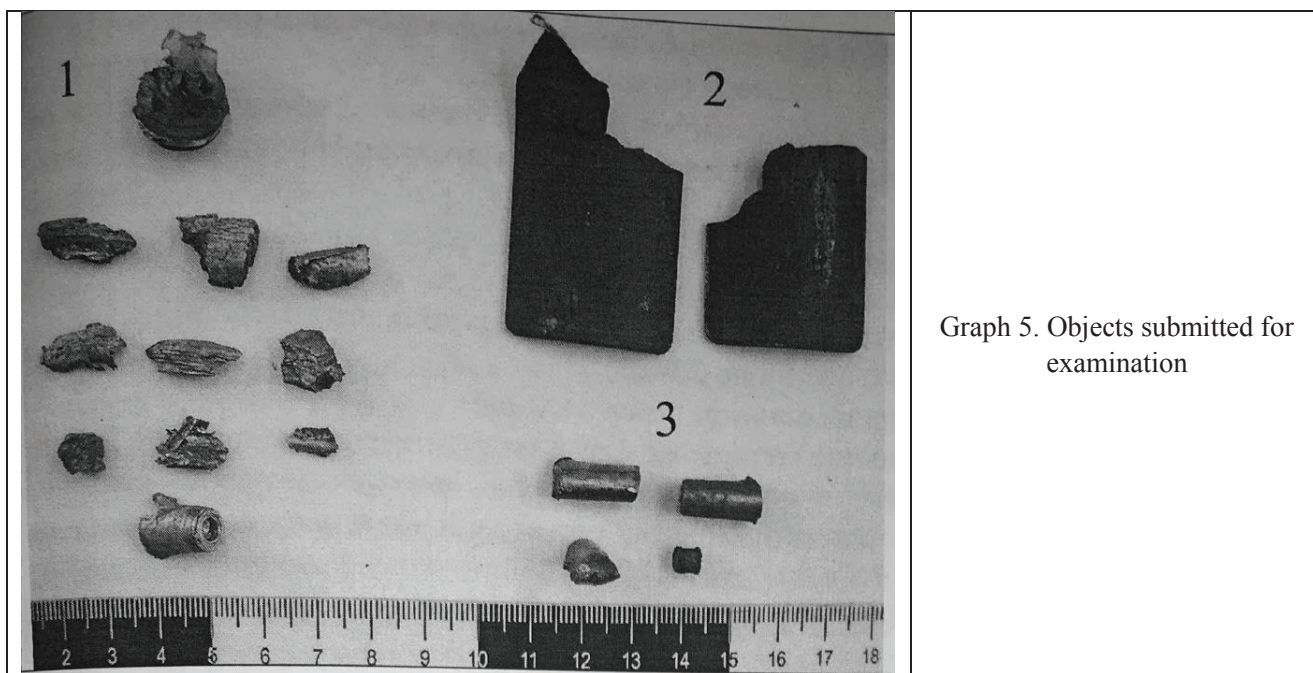

Graph 5. Objects submitted for examination

The examination of the objects established that they are fragments of metal and polymer material. The fragments have different metal thicknesses, different magnetizability, traces of technological processing, and layers of paint. Based on these criteria, they were combined into relevant groups, which were numbered 1–3.

The surfaces of the objects have a layer of a black substance that appears to be soot. For further chemical analysis, these objects were designated as **object No. 2**.

Upon being opened, pack No. 3 was found to contain objects with the general appearance shown in Graph 6.

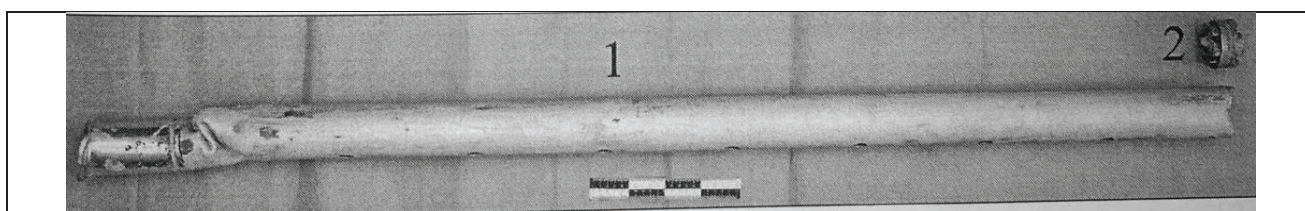

Graph 6. Objects submitted for examination

One object (Graph 6.1) is shaped like a hollow cylinder with one closed end and holes on its side surface. The other object (6.2) is a short, hollow cylinder with notches and protrusions on the ends.

The surfaces of the objects have a layer of a dark gray substance. For further chemical analysis, these objects were designated as **object No. 3**.

Forensic expert

[signature] V.V. Somov

Forensic expert

[signature] O.M. Pashkova

Chemical examination to identify explosive substances
(expert O.M. Pashkova)

The examination was conducted in accordance with the methodology [1]

Morphological examination

The examination was conducted with the help of a magnifying glass and under an MBS-2 stereo microscope (reflected light, magnification up to 24x).

The microscope examination revealed that:

- the surfaces of the metal fragments submitted in bag Nos. 1 and No. 2 contain solid particles of gray and beige color that appear to be soil. On the surfaces of some of the metal fragments are individual particles of a whitish-gray substance that appears to be the brisant explosive substance hexogen, as well as layer of a brittle yellowish-brown substance that appears to be rust;
- the surfaces of the cylindrical objects contain a layer of a dark gray substance. There are no layers of brown, yellow, white, black, gray or orange substances appearing to be explosive substances (TNT, tetryl, hexogen, PETN, *vuglenit*, M-58, octogen, okfol, Balistite).

For the sake of convenience, the contents of each of the submitted packs Nos. 1–3 have been designated by the expert as an “object” and numbered according to the numbering of the pack in which it (the object) was submitted for examination—object No. 1, object No. 2, object No. 3.

In order to determine whether any explosive substances or explosion products were present, the surfaces of the metal fragments and cylindrical objects were thoroughly washed with acetone and warm distilled water. The obtained extracts were individually filtered through paper filters and individually concentrated to a volume of ~10 ml each.

Chemical examination

In order to detect traces of explosives that might be present on the surface of object Nos. 1–3, the following tests were conducted:

- a universal indicator solution was added to parts of the objects, and the resulting mixtures turned greenish-yellow, which indicates their neutral environment;
- in order to establish the presence of inorganic and organic oxidizing compounds, a 5% solution of diphenylamine in concentrated sulfuric acid was added drop by drop to concentrated parts of water and acetone extracts from object Nos. 1–3;
- characteristic dark blue spots and streaks appeared in all of the resulting mixtures, which indicates the presence of oxidizing compounds in the water and acetone extracts that were tested;
- in order to detect aromatic nitro-derivatives, a few drops of 10% solution of potassium hydroxide in ethanol were added to parts of the objects. The reddish-brown coloration characteristic of aromatic

nitro-derivatives did not form in the mixtures, which can be explained by the absence of aromatic nitro-derivatives on the surfaces of the submitted objects;

- a solution of cobalt yellow was added to parts of the objects; the yellow precipitate that is indicative of the presence of potassium ions did not form (potassium ions are not present);

- a 2% solution of silver nitrate was separately added to parts of the objects acidified with nitric acid; the white sediment that is indicative of the presence of chlorine ions did not form (chlorine ions are not present);

- a 10% solution of barium chloride was added to parts of the objects; the white precipitate or white suspension that is indicative of the presence of sulfate ions did not form (sulfate ions are not present);

- adding a 0.1% solution of aniline sulfate in sulfuric acid to parts of the objects did not result in the formation of blue coloring in any of the mixtures (chlorate ions are not present);

- subsequently adding a solution of reagent 1 (a mixture of 1.6% methylene blue solution with 50% zinc sulfate solution) and reagent 2 (a 40% solution of potassium nitrate) did not result in the formation of purple coloring indicative of the presence of perchlorates (perchlorates are not present);

- parts of the objects were separately heated with 2 drops of sulfuric acid; after cooling with a solution of caustic potash, the pH environment reached 9, and Nessler reagent was added, but brownish-orange suspension or precipitate did not form (ammonium ions are not present);

- several drops of potassium iodide solution and acetic acid solution were added to the dry residue of the concentrated part of the objects; yellow coloring did not form in the obtained mixture (organic peroxide compounds are not present);

- Griess reagent was added to part of each of the water extracts; in the obtained mixtures with extracts from object Nos. 1–3, the pink coloring indicative of the presence of nitrite and nitrate ions formed, which indicates the presence of nitrite and nitrate ions in said water extracts.

Based on the results of qualitative chemical reactions, it was established that the following explosion products are not present on the surfaces of the objects: those based on ammonium nitrate, ammonites, ammonals, grammonites, grammonals, nitrate ester-containing explosives, detonators, chlorate and perchlorate explosives, explosive mixtures based on rare oxides (nitroparaffins, etc.), haloid and sulfide nitrogen compounds, and non-aromatic nitro-derivatives (nitromethane, nitrourea).

In order to detect traces of individual brisant explosives (tetryl, hexogen, PETN, TNT), traces of which may be present on the surfaces of the objects, the method of ascending thin-layer chromatography was used

Examination with thin-layer chromatography

Drops of previously obtained object Nos. 1–3 were applied to the starter strips of two SORBFIL chromatography plates using glass pipettes. Acetone solutions of the explosive substances (tetryl, hexogen, PETN, TNT) were applied to starter strips of the same plates as “markers.”

The chromatographic procedure was conducted in a system of organic acetone-toluol-hexane solvents in volume ratio of 1:1:2 respectively. After the eluent front was raised to a height of 10 cm, the plates were removed from the chamber and dried in the open air until the solvents were removed. One of the plates was developed with a 5% solution of diphenylamine in acetone. A low-intensity pale blue spot with an Rf value of 0.32 formed in each of the chromatographic areas of the acetone extracts from object Nos. 1 and 2 submitted for examination, which, in terms of color and chromatographic mobility, fully coincides with the “marker” (hexogen) spot. No other spots formed in the chromatographic areas of the acetone extracts from object Nos. 1 and 2. In the chromatographic area of object No. 3, no area or spot of any color formed, whereas a brown spot formed in the tetryl chromatographic area with an Rf value of 0.59; a green spot formed in the PETN chromatographic area with an Rf value of 0.7; and an orange spot formed in the TNT chromatographic area with an Rf value of 0.75.

The second plate was activated in the UV rays of a UFS 254/365 chromatographic irradiation machine at 254 nm and developed by a 10% ethanol solution of potassium hydroxide. In each of the chromatographic areas of the acetone extracts from submitted object No. 1 and No. 2, a low-intensity light yellow-pink spot formed with an Rf value of 0.92, which in terms of color and chromatographic mobility fully coincides with the “marker” (hexogen) spot. No other spots formed in the chromatographic areas of the acetone extracts from object Nos. 1 and 2. In the chromatographic area of object No. 3, no area or spot of any color formed, whereas a greenish-yellow spot formed in the tetryl chromatographic area with an Rf value of 0.54; a brownish-red spot formed in the PETN chromatographic area with an Rf value of 0.9; and a brown spot formed in the TNT chromatographic area with an Rf value of 0.85.

In summarizing and analyzing the results of the test, we can conclude that:

- the results of an external inspection, morphological examination, qualitative chemical reactions (the presence of oxidizers in the water and acetone extracts), and the results of the thin-layer chromatography indicate the following: the surfaces of the metal fragments submitted for examination in pack No. 1 and No. 2 bear traces of the brisant explosive cyclotrimethylenetrinitramine – hexogen;

- the traces of explosives (hexogen) found on the surface of some of the metal fragments submitted for examination in pack No. 1 and the traces of explosives (hexogen) found on the surface of some of the metal fragments submitted for examination in pack No. 2 coincide with each other in terms of outward appearance, solubility and chromatographic characteristics in a thin layer of sorbent. These coinciding attributes are affiliated in terms of their criminal significance. Thus, the traces of explosives (hexogen) found on the surface of some of the metal fragments submitted for

examination in pack No. 1 and the traces of explosives (hexogen) found on the surface of some of the metal fragments submitted for examination in pack No. 2 have a shared generic affiliation;

- on the surfaces of the cylindrical objects submitted for examination, there are no traces of explosives (tetryl, TNT, ammonite, oxtogen, balistite, hexogen, PETN) or products of their explosion, which was determined by an external inspection of the object, a morphological examination, qualitative chemical reactions during the testing of water and acetone extracts from the surfaces of the metal items, and the results of thin-layer chromatographic examination;

- the presence of oxidizers, nitrate ions, and nitrite ions in object No. 3 can be attributed to their general prevalence in the environment.

Forensic expert

[signature]

O.M. Pashkova

Explosives Examination
(expert V.V. Somov)

The examination was conducted in accordance with the methodology of [3].

The examination of the objects submitted in pack No. 1 established the following:

Object group No. 1 (graph 4.1) comprises: an object in the form of deformed ring made of gray magnetizable metal (iron alloy) with red paint on one side; a fragment of gray polymer material in the form of part of a circle; six arch-shaped fragments of gray, non-magnetizable metal (aluminum alloy) with red paint; a deformed ring (nut) made of gray, non-magnetizable metal (aluminum alloy) with a fragment of red paint in the form of a dot; fragments of gray, non-magnetizable metal (aluminum alloy) in the form of parts of a cylindrical surface, several of which have fragments of red paint.

The ring with red paint has the following dimensions: external diameter of 26.0 mm, internal diameter of 15.0 mm, metal thickness of 1.0 mm. The fragment of gray polymer material has the following dimensions: diameter of 17.0 mm, material thickness of 1.0 mm. The arch-shaped fragments with red paint have the following dimensions: maximum length of 15.6 mm, minimum length of 4.3 mm, metal thickness of 2.5 mm. The nut has the following dimensions: external diameter of 17.0 mm, internal diameter of 7.0 mm, metal thickness of 1.5 mm. The metal fragments in the form of parts of cylindrical surface have the following dimensions: maximum length of 21.2 mm, minimum length of 12.7 mm, metal thickness of 2.5–12.0 mm.

The objects do not bear any markings.

The metal edges of the fragments are irregular (torn) and bear traces of stretching (plastic deformation). The surfaces of the metal fragments bear dents, scratches, cracks, and a layer of black substance that appears to be soot. The damage to the metal fragments was caused by the force of explosion.

The arch-shaped fragments with red paint have common surfaces of separation by which they may be combined, which indicates that they previously formed part of a single object, which had the shape of a ring (Graph 7).

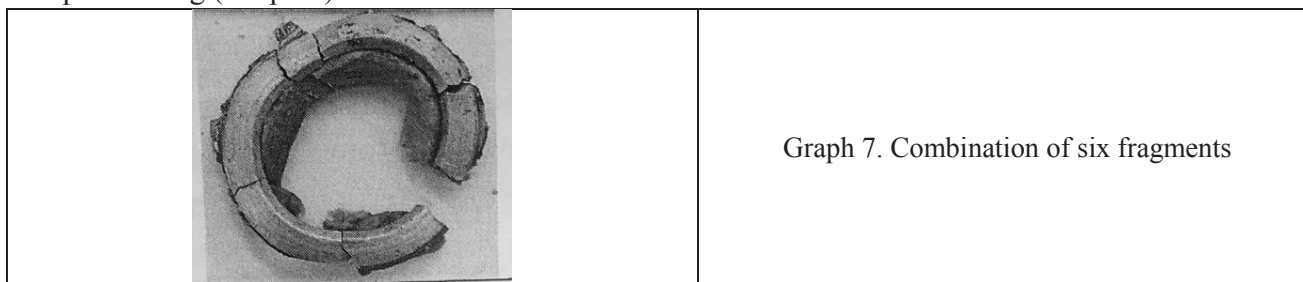

The other objects in this group do not have common surfaces of separation.

Object group No. 2 (graph 4.2) comprises four objects that share the same structure. The objects are made of gray, magnetizable metal with black paint. The objects are rectangular in shape with longitudinal, trough-like curvature. One edge of each object is irregular (torn). The dimensions of the objects are as follows: maximum height of 58.4 mm, minimum height of 26.3 mm, width of 32.5 mm, metal thickness of 1.4 mm.

The objects bear no markings.

The metal edges of the objects are irregular (torn) at the rupture points and bear traces of stretching (plastic deformation) and thinning.

The surfaces of the objects bear dents, scratches, and a layer of black substance that appears to be soot. The damage to the objects was caused by the force of explosion.

The objects of this group do not have common surfaces of separation.

Group No. 3 includes an object made of gray, magnetizable metal (iron alloy). The object is in the shape of a cylinder, at the base of which lies a parabola limited by a section of an arc. The dimensions of the object are: length of 16.0 mm, height of parabola: 6.5 mm. The object weighs 4.34 g.

The object does not bear any markings.

The surfaces of the objects bear dents, scratches, and a layer of black substance that appears to be soot.

Object group No. 4 consists of two metal fragments. The larger fragment is made of a relatively light, gray, non-magnetizable metal (aluminum alloy) with a protective coating of light green color.

The smaller fragment is made of gray, magnetizable metal (iron alloy). The metal fragments have trough-like curvature, which indicates that they formed part of cylindrical objects. The larger fragment has a collar on the inside, while the smaller fragment has a notch.

The dimensions of the fragments are as follows: the larger fragment measures 43.6x17.8 mm with a metal thickness of 2.5 mm, while the smaller measure 20.6x12.8 mm with a metal thickness of 5.0 mm.

The objects do not bear any markings.

The metal edges of the fragments are irregular (torn) and show signs of stretching (plastic deformation). The surfaces of the metal fragments bear dents, scratches, and a layer of a black substance that appears to be soot. The damage to the metal fragments was caused by the force of explosion.

The examination of the objects submitted in pack No. 2 revealed the following:

Object group No. 1 (graph 5.1) comprises:

- an object that consists of a cross piece made of gray polymer material, nuts made of gray, non-magnetizable metal (aluminum alloy), lining made of black plastic material that appears to be rubber, and a flattened cylinder made of gray, non-magnetizable metal (aluminum alloy). A cylinder-shaped spring can be seen under the cross piece.

- gray, non-magnetizable metal fragments in the form of parts of a cylindrical surface;

- a cylindrical object with a blind hole on the end, made of gray, non-magnetizable metal (aluminum alloy).

The object of complex construction has a maximum diameter of 17.0 mm and a height of 18.2 mm. The metal fragments in the form of parts of a cylindrical surface have a maximum length of 20.9 mm, a minimum length of 9.3 mm, and a metal thickness of 3.0–8.9 mm. The cylindrical object measures 14.0 mm in length and 8.5 mm in diameter.

There are no markings on the objects.

The edges of the fragments are irregular (torn) and show signs of stretching (plastic deformation). The surfaces of the metal fragments bear dents, scratches, cracks, and a layer of a black substance that appears to be soot. The damage to the metal fragments was caused by the force of explosion.

The objects of this group do not have common surfaces of separation.

Object group No. 2 (graph 5.2) comprises two objects of identical construction. The objects are made of gray, magnetizable metal (iron alloy) with black paint. The objects are rectangular in shape with longitudinal, trough-like curvature. One edge of each object is irregular (torn). The dimensions of the objects are as follows: maximum height of 57.6 mm, minimum height of 40.8 mm, width of 32.5 mm, metal thickness of 1.4 mm.

[text cut off]

The metal edges of the objects are irregular (torn) at the rupture points and bear traces of stretching (plastic deformation) and thinning.

The surfaces of the objects bear dents, scratches, and a layer of a black substance that appears to be soot. The damage to the objects was caused by the force of explosion.

The objects of this group do not have common surfaces of separation.

Object group No. 3 (graph 5.3) comprises three objects in the shape of right cylinders, at the base of which lies a parabola limited by a section of an arc, and one object in the shape of a right circular cylinder. All of the objects are made of gray, magnetizable metal (iron alloy). The three objects have the following dimensions: 15.5, 16.0 and 16.5 mm in length, height of the parabola: 6.5 mm. Weight of the objects: 4.28, 4.34, and 4.36 g.

The object in the shape of a right circular cylinder has the following dimensions: 5.0 mm in length, 5.0 mm in diameter. Weight of the object: 0.72 g.

The objects do not bear any markings.

The surfaces of the objects bear dents, scratches, and a layer of a black substance that appears to be soot.

The objects of this group do not have common surfaces of separation.

The objects submitted in pack No. 1 and No. 2, except for the objects in pack No. 1 that belong to group No. 1 (graphs 4.1 and 7) do not have common surfaces of separation, so it does not appear possible to determine whether they previously formed parts of a single object.

A comparative examination of the structural features, dimensions, and weights of the submitted fragments with the structural features, dimensions and weights of weapons and munitions provided in the reference literature shows that they previously formed parts of the fuse and body (graph 4.1, graph 5.1) and stabilizer blades (graph 4.2, graph 5.2) of a 9N235 warhead fragmentation element(s) fitted with pre-formed fragments (graph 4.3, graph 5.3).

An examination of the objects submitted in pack No. 3 revealed the following:

An object (graph 6.1) shaped like a hollow cylinder closed at one end. The object consists of a tube with nine pairs of through holes on the side surface and a cup, closely connected to each other. The pipe and cup are made of gray, non-magnetizable metal. The metal is dull on the outer surface of the tube and shiny on the inside surface of the cup. The outer surfaces of the object have a layer of a gray substance that appears to be metal oxides. The bottom of the cup is formed by a plug, which is connected to the cup by a threaded connection. On the open end of the tube at a distance of 7.0 mm from the end there is a neck measuring 5.5 mm in width.

The object has metal deformation in the form of dents on the side of the open end of the tube, dents on the end of the cup, and metal deformation of the tube in the form of corrugations.

Dimensions of the object: total length – 1,620.7 mm, cup length – 155.0 mm, external tube diameter – 75.5 mm, diameter of the holes – 20.0 mm, tube metal thickness – 2.0 mm, tube metal thickness on the open end at a length of 23.6 mm is 1.0 mm.

The object bears the following markings: on the bottom of the cup—engraved (depressed) characters in two rows: “9X59-70” and “61-90” (graph 8), and on the side surface of the cup and tube, in black paint: “6722300,” “63,” “7,” and “MS” (graph 9).

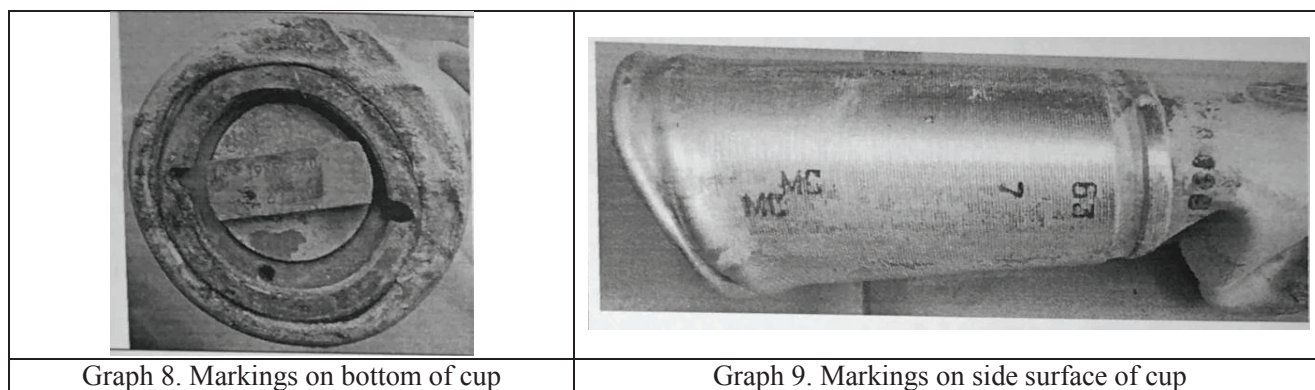

An object (graph 6.2) in the form of a hollow cylinder, open at both ends.

At one end of the object there is a cross-shaped cutout and two flattened surfaces (graph 10, a). At the opposite end are six protuberances arranged in a circle. On the side surface of the object at a distance of 7.0 mm from the bottom of the flattened surface there is a ring-shaped groove 6.0 mm in width (graph 10, b).

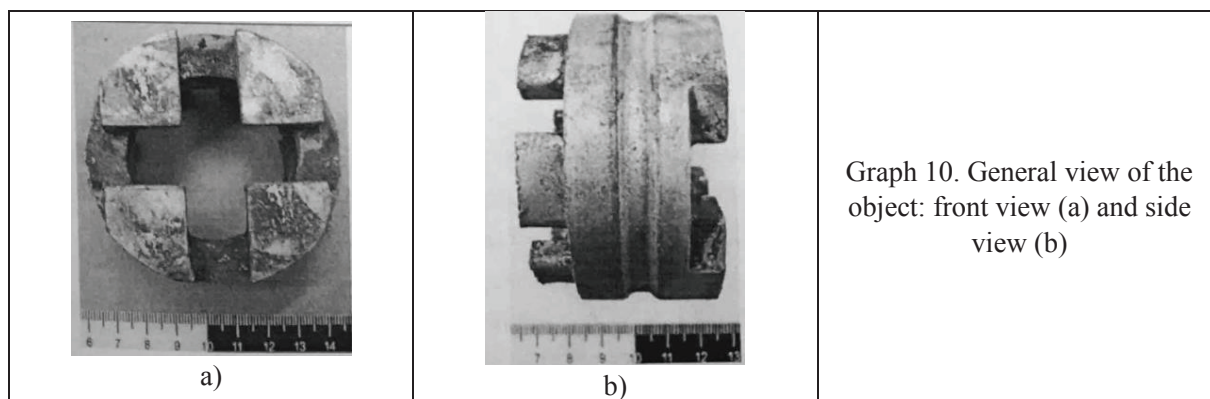

Dimensions of the object: length – 43.0 mm, external diameter – 72.4 mm, internal diameter – 50.0 mm.

The objects bear no markings.

There is a scratch on the front surface of the object. A layer of dark gray substance can be seen on the surfaces of the object.

The objects do not have common surfaces of separation, but one of the objects (graph 6.2), when inserted into the open end of the object's tube (graph 6.1), forms a single structure. The ring grooves on the object (graph 6.2) and the ring neck on the tube fit together, and their dimensions coincide. Together, the objects form a magazine, in the middle of which a 9N235 warhead fragmentation element is placed.

The results of the completed examination allow us to state that the objects and fragments submitted in pack Nos. 1 and 2 belong to a 9N235 warhead fragmentation element (or elements), which are fitted into a magazine, parts of which were submitted in pack No. 3. Such magazines make up a 9N139 cluster head. A 9N139 cluster head is a component of a 300-mm rocket-propelled shell used in a Smerch multiple rocket launcher.

Forensic expert

[signature] V.V. Somov

Synthesis

(experts V.V. Somov and O.M. Pashkova)

In summarizing and analyzing the results of the examinations, we should conclude that:

- the surfaces of the metal fragments submitted for examination in pack No. 1 and No. 2 bear traces of the brisant explosive cyclotrimethylenetrinitramine – hexogen;

- the traces of explosives (hexogen) found on the surface of some of the metal fragments submitted for examination in pack No. 1 and the traces of explosives (hexogen) found on the surface of some of the metal fragments submitted for examination in pack No. 2 have a shared generic affiliation. It does not appear possible to identify the group affiliation of submitted object Nos. 1–2 due to the absence of group features;

- the surfaces of the cylindrical objects submitted for examination in pack No. 3 do not bear traces of explosives (tetryl, TNT, ammonite, octogen, balistite, hexogen, PETN) or explosion products;

- the fragments submitted in pack No. 1 and No. 2 are fragments of a 9N235 warhead fragmentation element (or elements) fitted with pre-formed fragments;

- the objects submitted in pack No. 3 are parts of a magazine that forms part of the cluster head of a 300-mm rocket-propelled shell.

Forensic expert

[signature] V.V. Somov

Forensic expert

[signature] O.M. Pashkova

CONCLUSIONS

1. The objects and fragments submitted for examination belong to a 300-mm rocket-propelled shell with a warhead cluster containing warhead fragmentation elements, used in a Smerch multiple rocket launcher

Forensic expert
Senior Research Fellow

[seal:]
Prof. Emeritus M.S.
Bokarius Kharkiv Scientific
Research Institute of
Forensic Expert
Examinations, Ministry of
Justice of Ukraine, [illegible]

[signature] V.V. Somov

2, 4. The surfaces of the metal fragments submitted for examination in pack No. 1 and No. 2 bear traces of the brisant explosive cyclotrimethylenetrinitramine – hexogen.

The surfaces of the cylindrical objects submitted for examination in pack No. 3 do not bear traces of explosives (tetryl, TNT, ammonite, octogen, balistite, hexogen, PETN) or explosion products.

The traces of explosives (hexogen) found on the surface of some of the metal fragments submitted for examination in pack No. 1 and the traces of explosives (hexogen) found on the surface of some of the metal fragments submitted for examination in pack No. 2 have a shared generic affiliation. It does not appear possible to identify the group affiliation of submitted object Nos. 1–2 due to the absence of group features.

Forensic expert

[seal:]
Prof. Emeritus M.S. Bokarius Kharkiv
Scientific Research Institute of Forensic
Expert Examinations, Ministry of
Justice of Ukraine, [illegible]

[signature] O.M. Pashkova

3. A description of the fragments and objects that previously formed a single object and a unified structure is provided in the examination section of the opinion.

5. The 300-mm rocket-propelled shells with warhead clusters containing warhead fragmentation elements, fragments of which were submitted for examination, are used in a Smerch multiple rocket launchers.

Forensic expert
Senior Research Fellow

[seal:]
Prof. Emeritus M.S. Bokarius
Kharkiv Scientific Research
Institute of Forensic Expert
Examinations, Ministry of
Justice of Ukraine, [illegible]

[signature] V.V. Somov

Notes: 1. The chromatograms are under supervisory review.

2. Copies of the criminal case files in a single volume consisting of 98 pages, as well as the objects and fragments in two polymer packs, are being returned together with the expert opinion.

[signature]

[seal:]
Prof. Emeritus M.S.
Bokarius Kharkiv Scientific
Research Institute of
Forensic Expert
Examinations, Ministry of
Justice of Ukraine,
[illegible]

[signature]

Annex 140

Inspection Report by Colonel Roman Stepanovich Kovalchuk, Head of Operational Group of Military Counterintelligence of the Security Service of Ukraine (23 November 2015)

This document has been translated from its original language into English, an official language of the Court, pursuant to Rules of the Court, Article 51.

Pursuant to Rules of the Court Article 51(3), Ukraine has translated only an extract of the original document constituting this Annex. In further compliance with this Rule, Ukraine has provided two certified copies of the full original-language document

Inspection report

Donetsk region
Krasnoarmeysky district
Merchik village

November 23, 2015
Inspection commenced at 12:00 p.m.
Inspection completed at 01:20p.m.

Colonel Roman Stepanovich Kovalchuk, the Head of operational group of military counterintelligence of Security Service of Ukraine in “Б” sector in the anti-terrorist operation area with the participation of the following experts: Ivan Yaroslavovich Venger, the fitter of Lviv Armored Plant and Vladimir Miroslovovich Dyakiva, the electrical fitter of Lviv Armored Plant on the basis of Clause 25 of the Law of Ukraine “About the Security Service of Ukraine”, Clause 8 of the Law of Ukraine “About operational search activity” and Clause 15 of the Law of Ukraine “About counter-terrorism” has examined of the tank of T-72 type located in the wood line near Merchik village of Krasnoarmeyskiy district, Donetsk region.

During this inspection, the pictures were taken by means of “iPhone” device.

The inspection showed:

There is a tank of T-72 type of dark-green color in the wood line near Merchik village of Krasnoarmeyskiy district, Donetsk region.

The front part of the hull, as well as lateral protection parts of caterpillars, is equipped with explosive-reactive armor means in the form of metal boxes.

During visual inspection of the tank, it was found that the protective metal parts of caterpillars and front parts of the hull have such damages as dents, nicks and metal ruptures. In the course of inspection, the pictures of tank were taken and the pictures of all its sides were attached to this report as Annexes No 1 - 4.

Then, during inspection, it was found that the tank has alphanumeric designations as the following:

- embossed alphanumeric designation “B 50” on the front hull (this designation is pictured and the picture is added to this report as **Annex No 5**);
- embossed alphanumeric designation "2J46106012J159 NA220" (this designation is pictured and the picture is added to this report as **Annex No 6**) on the tank gun barrel;
- "2A-46M1 " designation of tank gun type in the tank fighting compartment;
- "4БЛШ1 119" designation of tank sight number at the gunner's station;
- "ИОЗВТ 6250" designation on the transfer case of the right gear box in the engine compartment;
- "ИОЗВТ 6217" designation on the transfer case of the left gear box in the engine compartment.

After that, in order to restore the tank serial number which is located in hull front part, two explosive-reactive armor boxes were unscrewed by means of wrench and it was found that there is an embossed alphanumeric designation of "ИО3BT6265" (this designation is pictured and the picture is added to this report as **Annex No 7**) under them on the hull.

At that, the both specialists V. M. Dyakiv and I. Ya. Venger assured that the inspected tank was of T-72 Б 1 modification being armed with Russian Armed Forces and besides, they pointed out the distinctive features of the above mentioned fighting vehicle in comparison with tanks of T-72 type being armed with Ukrainian Armed Forces, that is:

-on the inspected tank, the air valve "ИЛ" is arranged in the transmission compartment, while in the Ukrainian tanks, it is in the fighting compartment (in the turret), (the picture is attached to this report as **Annex No 8, 9**);

-factory seal is available on all units, assemblies of this tank (Ukrainian tanks of T-72 type were overhauled at the armored factories (in Lviv and Kyiv) and therefore they cannot have the manufacturer's factory seal), (the picture is attached to this report as **Annex No 10**);

-the inspected tank has an hour meter under load (such hour meter under load is not installed in Ukrainian tanks), (the picture is attached to this report as **Annex No 11**);

- fans of "ДБ-3" type are at the crew stations (after overhaul, the Ukrainian tanks have fans of foreign production (mostly of China)), (the picture is attached to this report as **Annex No 12**);

- the inspected tank has the fuel heating system (in tanks of T-72 type being armed with Ukrainian Armed Forces, such system was removed during overhaul).

The pictures are attached to this inspection report as Annexes No 1-12, total 12 sheets, and they are also recorded on the CD-R disc which is also attached to this report.

Experts /signature/ V. M. Dyakiv
 /signature/ I. Ya. Venger

Inspection was conducted and report was drawn up by:

**Head of operational group of military counterintelligence
of Security Service of Ukraine in "Б" sector
in the anti-terrorist operation area
Colonel**

/signature/ **R. Kovalchuk**

November 23, 2015

Picture table to inspection report dated 23.11.2015

Picture No 1



General view of T-72 tank (front view)

Head of operational group of military counterintelligence
of Security Service of Ukraine in sector "B" sector
in the anti-terrorist operation area
Colonel

/signature/

R. Kovalchuk

Picture table to inspection report dated 23.11.2015

Picture No 2



General view of T-72 tank (view from the right side)

Head of operational group of military counterintelligence
of Security Service of Ukraine in sector "B" sector
in the anti-terrorist operation area
Colonel

/signature/

R. Kovalchuk

Picture table to inspection report dated 23.11.2015

Picture No 3



General view of T-72 tank (view from the left side)

Head of operational group of military counterintelligence
of Security Service of Ukraine in sector "B"
in the anti-terrorist operation area
Colonel

/signature/

R. Kovalchuk

Picture table to inspection report dated 23.11.2015

Picture No 4



General view of T-72 tank (back view)

Head of operational group of military counterintelligence
of Security Service of Ukraine in sector "B"
in the anti-terrorist operation area

Colonel

/signature/

R. Kovalchuk

Picture table to inspection report dated 23.11.2015

Picture No 5



- Embossed alphanumeric designation "B 50" on the front hull

Head of operational group of military counterintelligence
of Security Service of Ukraine in sector "B"
in the anti-terrorist operation area
Colonel

/signature/

R. Kovalchuk

Picture table to inspection report dated 23.11.2015

Picture No 6



- Embossed alphanumeric designation
“2J46106012J159 NA220” on the T-72 tank barrel

Head of operational group of military counterintelligence
of Security Service of Ukraine in sector “B”
in the anti-terrorist operation area
Colonel

/signature/

R. Kovalchuk

Picture table to inspection report dated 23.11.2015

Picture No 7



- Embossed alphanumeric designation
“ИОЗВТ6265” on the T-72 hull front

Head of operational group of military counterintelligence
of Security Service of Ukraine in sector “B”
in the anti-terrorist operation area
Colonel

/signature/

R. Kovalchuk

Picture table to inspection report dated 23.11.2015

Picture No 8



Air valve “ИЛ” in the transmission compartment

Head of operational group of military counterintelligence
of Security Service of Ukraine in sector “B”
in the anti-terrorist operation area
Colonel

/signature/

R. Kovalchuk

Picture table to inspection report dated 23.11.2015

Picture No 9



Air valve “ИЛ” in the transmission compartment

Head of operational group of military counterintelligence
of Security Service of Ukraine in sector “B”
in the anti-terrorist operation area
Colonel

/signature/

R. Kovalchuk

Picture table to inspection report dated 23.11.2015
Picture No 10



Factory seal on tank units

Head of operational group of military counterintelligence
of Security Service of Ukraine in sector "B"
in the anti-terrorist operation area
Colonel

/signature/

R. Kovalchuk

Picture table to inspection report dated 23.11.2015
Picture No 11



Hour meter under load

Head of operational group of military counterintelligence
of Security Service of Ukraine in sector "B"
in the anti-terrorist operation area
Colonel

/signature/

R. Kovalchuk

Picture table to inspection report dated 23.11.2015

Picture No12



Fans of "ДВ-3" type at crew stations

Head of operational group of military counterintelligence
of Security Service of Ukraine in sector "B"
in the anti-terrorist operation area
Colonel

/signature/

R. Kovalchuk

Annex 141

Inspection Report by Colonel Vasyl Vasyliovych Kolodiazhnyi, the Deputy Head of Operational Group of Military Counterintelligence of the Security Service of Ukraine, B Sector (27 November 2015)

This document has been translated from its original language into English, an official language of the Court, pursuant to Rules of the Court, Article 51.

Pursuant to Rules of the Court Article 51(3), Ukraine has translated only an extract of the original document constituting this Annex. In further compliance with this Rule, Ukraine has provided two certified copies of the full original-language document

Inspection report

Donetsk region
Yasynuvata district
Progress village

November 27, 2015
inspection commenced at 10.30 am
inspection completed at 12.00 am

Colonel Vasyl Vasyliovych Kolodiazhnyi, the Deputy Head of operational group of military counterintelligence of Security Service of Ukraine in “B” sector in the anti-terrorist operation area with the participation of the following experts: tank gunner of the 3rd platoon, 3rd military unit, 2nd separate tank battalion (military unit B1193) soldier Oleksandr Mykhailovych Pavlov and machine operator of the 3rd platoon, 3rd military unit, 2nd separate tank battalion (military unit B1193), sergeant Ivan Volodymyrovych Chaikovsky, based on Cl. 25 of the Law of Ukraine “About the Security Service of Ukraine”, cl. 8 of the Law of Ukraine “About criminal investigation”, cl. 15 of the Law of Ukraine “About counter-terrorism”, has examined tank of T-72 type, located in the wood line near Progress village of Yasynuvata district of Donetsk oblast.

During this inspection, pictures were taken by means of “iPhone” device.

The inspection showed:

There is a tank of T-72 type of dark-green color in the wood line near Progress village of Yasynuvata district of Donetsk oblast.

The front part of the hull, as well as lateral protection parts of caterpillars, are equipped with explosive-reactive armor means in the form of metal boxes.

During visual inspection of the tank, it was found that the protective metal parts of caterpillars and front parts of the hull have such damages as dents, nicks and metal ruptures.

In the course of inspection, pictures of tank were taken and pictures of all its sides were attached to this report as **Annexes No 1 - 4**.

Then, during inspection, it was found that the tank has alphanumeric designations as the following:

- embossed alphanumeric tank serial number: “И04BT8149” on the front hull (this designation is pictured and the picture is added to this report as **annex No5**);
- embossed alphanumeric designation “2A46CB01-2 NA1155” on the tank gun barrel (this designation is pictured and the picture is added to this report as **annex No6**);
- embossed alphanumeric designation “Д11BT1924” on the tank fighting compartment (this designation is pictured and the picture is added to this report as **annex No7**);

continuation of inspection report dated 23.11.2015

- "6БЛТ184" designation of tank sight number at the gunner's station (this designation is pictured and the picture is added to the report as **annex No 8**);
- "Н1АДЦИ662" designation of tank rangefinder at the gunner's station (this designation is pictured and the picture is added to the report as **annex No 9**);
- "И12РТ0871" designation on the transfer case of the right gear box in the engine compartment;
- "X01РТ5014" designation on the transfer case of the left gear box in the engine compartment;
- The tank-driver cabin contains 4 units of batteries of 6СТ-140ТМ type, with manufacturer's label, containing the following information: "Electrotiaga" Closed Joint-Stock Company". Accumulator starting battery 6СТ-140ТМ. ТУ 16-529.357-78. Russian Federation, 198095, city of St. Petersburg, 50А, Kalinina str., tel. (812) 7863244, (812) 7862889, fax: (812) 7864739. The warranty period - 3 years". One of the terminals in the upper battery part contains embossed numerical designation "844" and "1213", which is the battery number and the manufacture date – December of year 2013 (these designations are pictured and the pictures are added to the report as **annexes No 10-13**).

At that, the both specialists, Pavlov O. M. and Chaikovsky I.V. assured that the inspected tank was of T-72 Б 1 modification being armed with Russian Armed Forces and besides, they pointed out the distinctive features of the above mentioned fighting vehicle in comparison with tanks of T-72 type being armed with Ukrainian Armed Forces, that is:

- on the inspected tank, the air valve "ИЦ" is arranged in the transmission compartment, while in the Ukrainian tanks, it is in the fighting compartment (in the turret), (the picture is attached to this report as **Annexes No 14, 15**)

- factory seal is available on all units, assemblies of this tank (Ukrainian tanks of T-72 type were overhauled at the armored factories (in Lviv and Kyiv) and therefore they cannot have the manufacturer's factory seal), (the picture is attached to this report as **Annex No 16**);

- the inspected tank has an hour meter under load (such hour meter under load is not installed in Ukrainian tanks), (the picture is attached to this report as **Annex No 17**);

- fans of "ДВ-3" type are at the crew stations (after overhaul, the Ukrainian tanks have fans of foreign production (mostly of China)), (the picture is attached to this report as **Annex No 18**);

continuation of inspection report dated 23.11.2015

- the inspected tank has the fuel heating system (in tanks of T-72 type being armed with Ukrainian Armed Forces, such system was removed during overhaul).

The pictures are attached to this inspection report as Annexes No 1-18, total 18 sheets, and they are also recorded on the CD-R disc which is also attached to this report.

Experts: _____

Inspection was conducted and report was drawn up by:

**Deputy Head of operational group of military counterintelligence
of Security Service of Ukraine in “Б” sector
in the anti-terrorist operation area
Colonel**

V. Kolodyazhni

27.11.2015

Picture table

To the protocol of inspection of tank T-72B1 №И04BT8149 as of 27 November 2015 (Annexes №1 - №18)

Picture № 1



Deputy Head of operational group of military counterintelligence
of Security Service of Ukraine in sector "B"
in the anti-terrorist operation area
Colonel

/signature/

V. Kolodyazhni

Picture № 2



Deputy Head of operational group of military counterintelligence
of Security Service of Ukraine in sector "B"
in the anti-terrorist operation area
Colonel

/signature/

V. Kolodyazhni

Picture № 3



Deputy Head of operational group of military counterintelligence
of Security Service of Ukraine in sector "B"
in the anti-terrorist operation area
Colonel

/signature/

V. Kolodyazhni

Picture № 4

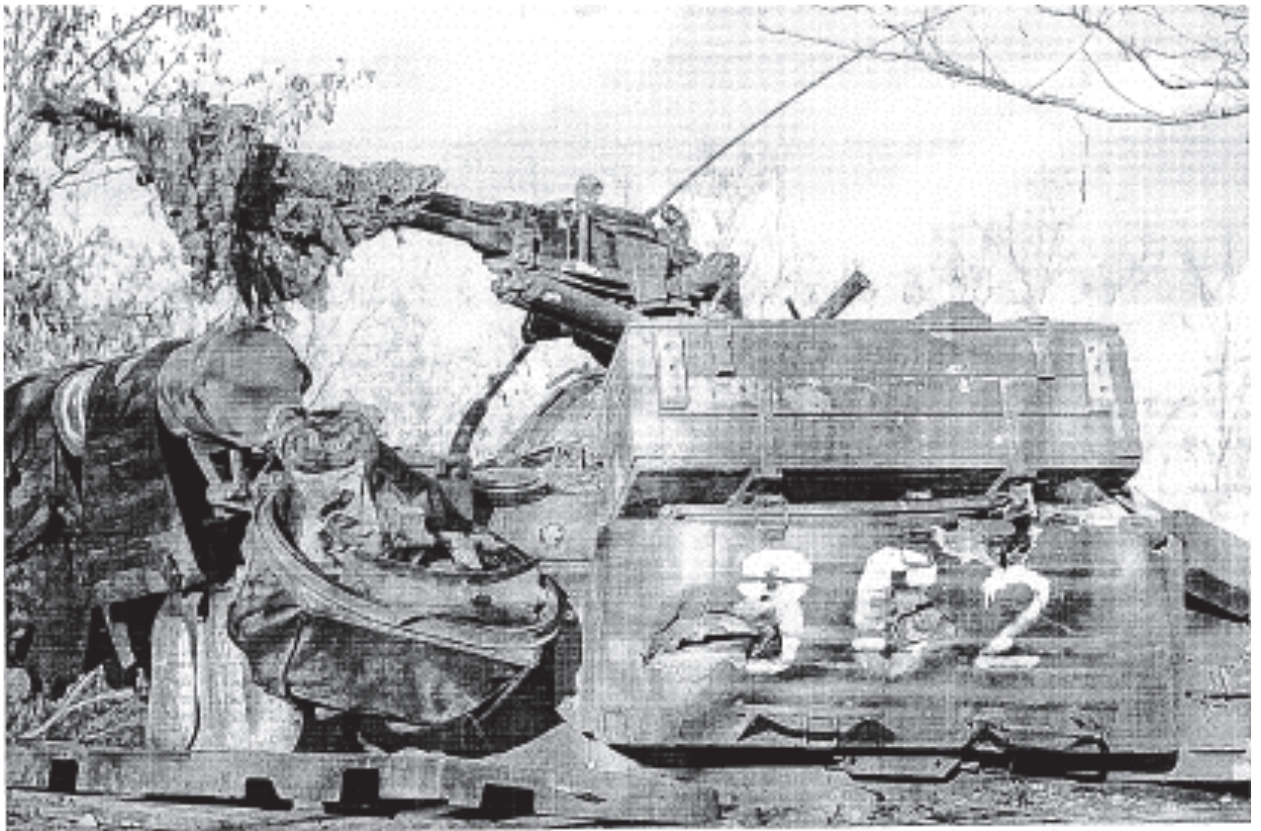

Deputy Head of operational group of military counterintelligence
of Security Service of Ukraine in sector "B"
in the anti-terrorist operation area
Colonel

/signature/

V. Kolodyazhni

Picture № 5

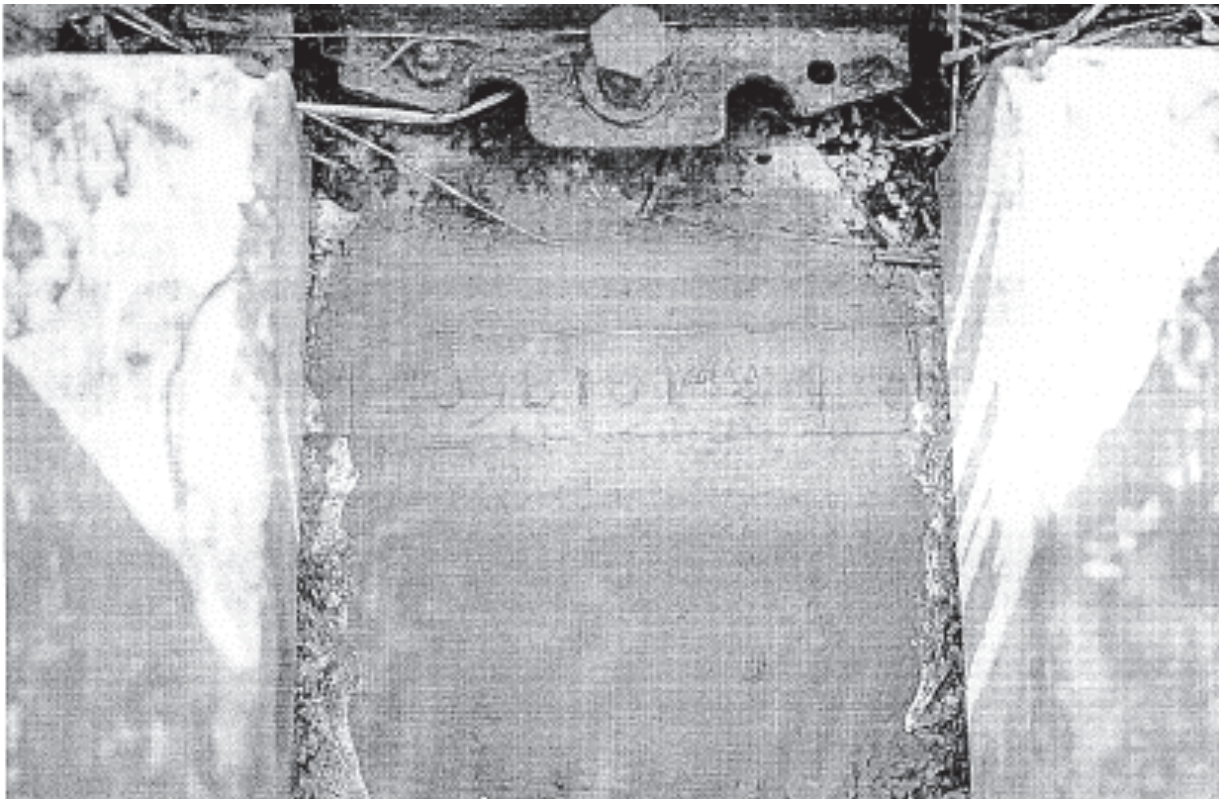

Deputy Head of operational group of military counterintelligence
of Security Service of Ukraine in sector "B"
in the anti-terrorist operation area
Colonel

/signature/

V. Kolodyazhni

Picture № 6

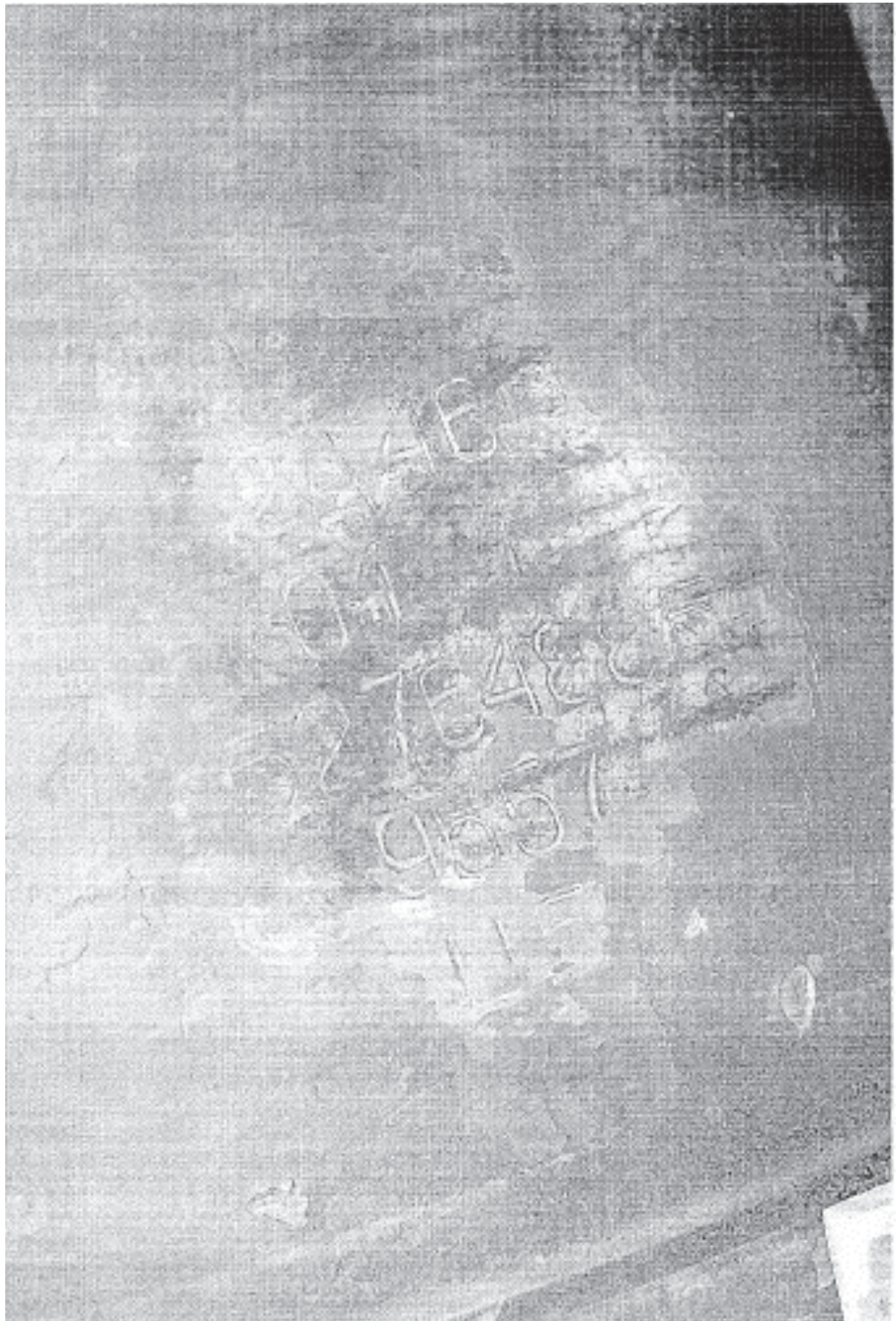

Deputy Head of operational group of military counterintelligence
of Security Service of Ukraine in sector "B"
in the anti-terrorist operation area
Colonel

/signature/

V. Kolodyazhni

Picture № 7

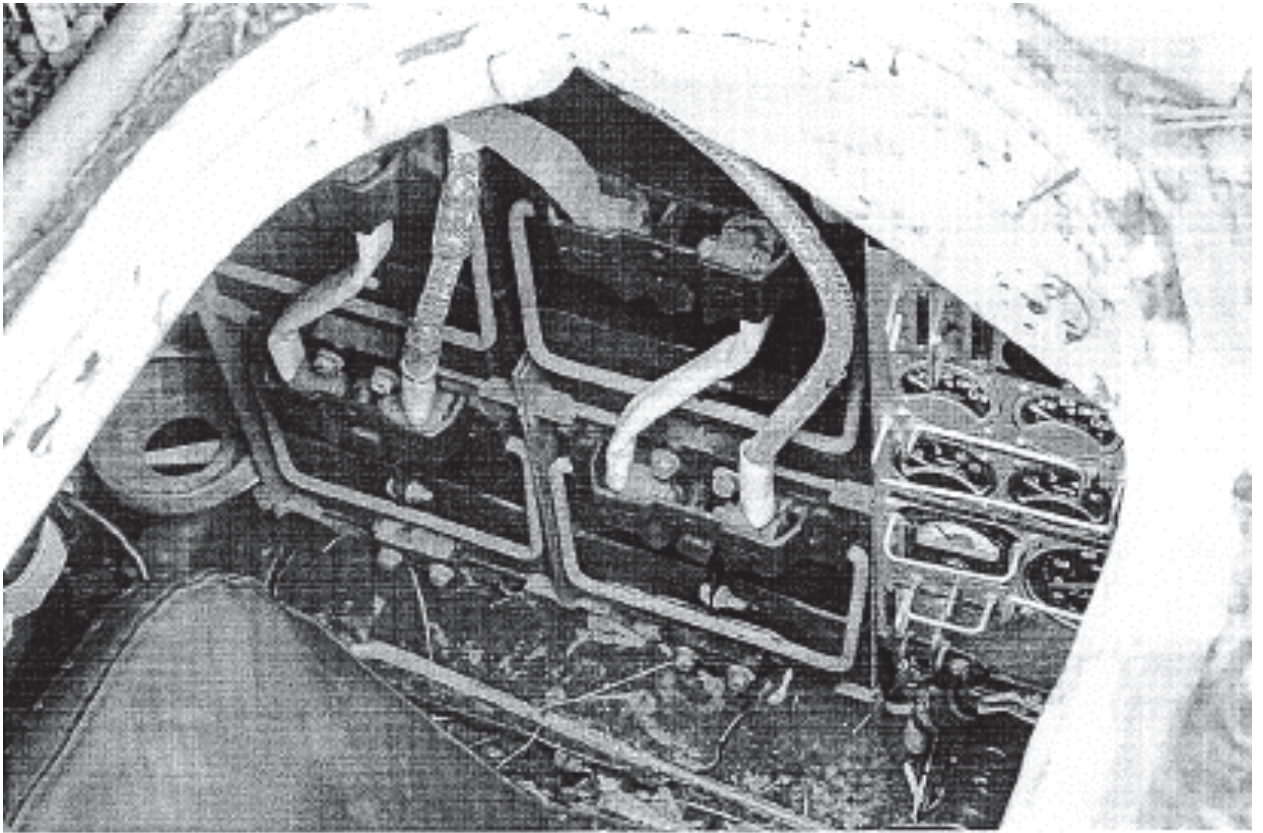

Deputy Head of operational group of military counterintelligence
of Security Service of Ukraine in sector "B"
in the anti-terrorist operation area
Colonel

/signature/

V. Kolodyazhni

Continuation sheet to the picture table of the protocol of inspection as of 27 November 2015

Picture № 8

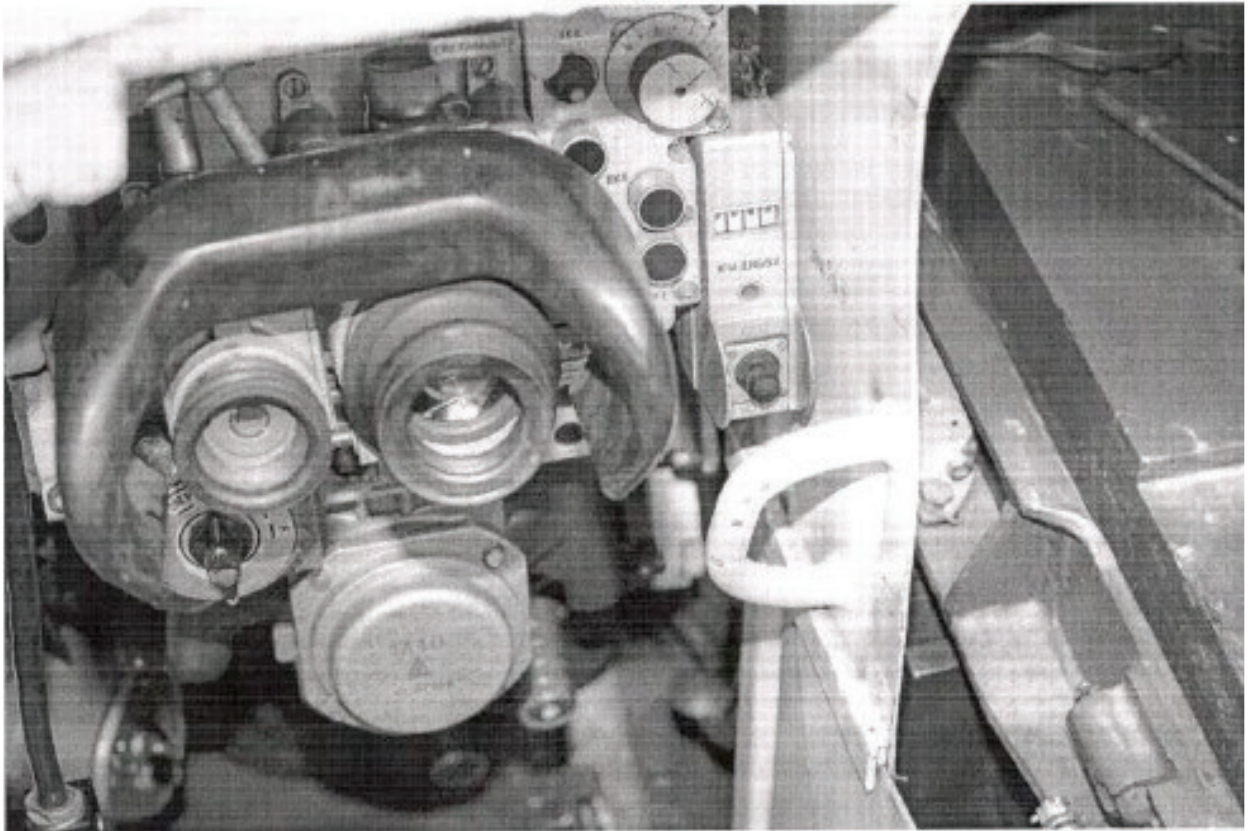

Deputy Head of operational group of military counterintelligence
of Security Service of Ukraine in sector "B"
in the anti-terrorist operation area
Colonel

/signature/

V. Kolodyazhni

Picture № 9

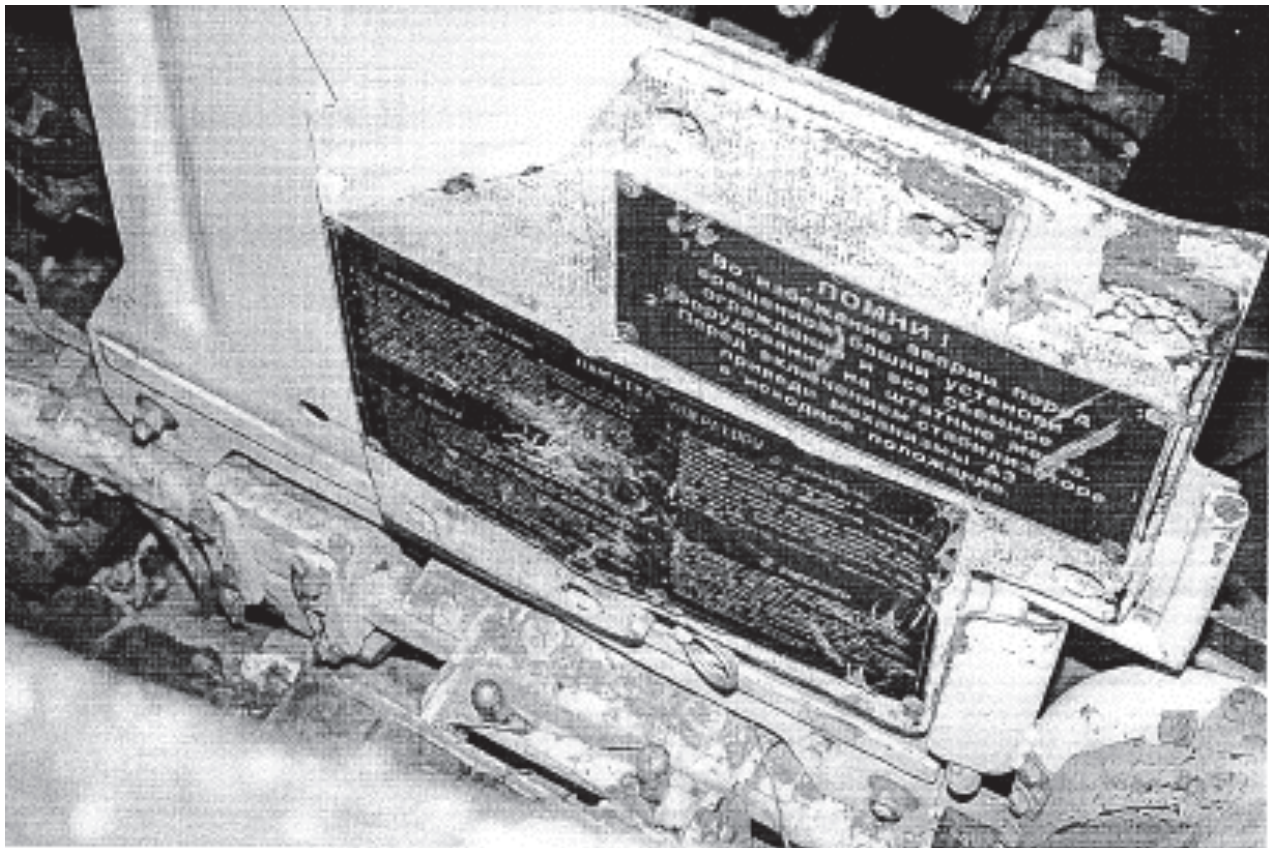

Deputy Head of operational group of military counterintelligence
of Security Service of Ukraine in sector "B"
in the anti-terrorist operation area
Colonel

/signature/

V. Kolodyazhni

Continuation sheet to the picture table of the protocol of inspection as of 27 November 2015

Picture № 10



Deputy Head of operational group of military counterintelligence
of Security Service of Ukraine in sector "B"
in the anti-terrorist operation area
Colonel

/signature/

V. Kolodyazhni

Picture № 11

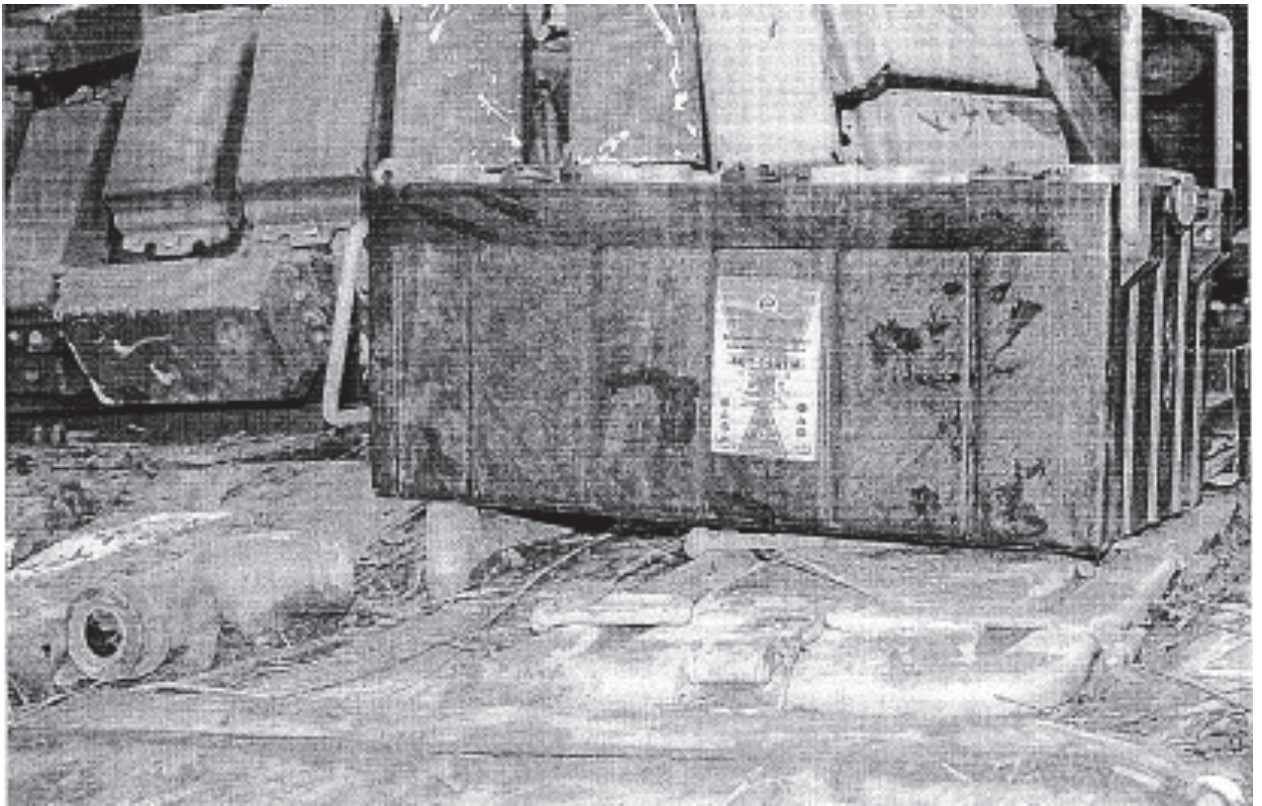

Deputy Head of operational group of military counterintelligence
of Security Service of Ukraine in sector "B"
in the anti-terrorist operation area

Colonel

/signature/

V. Kolodyazhni

Picture № 12



Deputy Head of operational group of military counterintelligence
of Security Service of Ukraine in sector "B"
in the anti-terrorist operation area
Colonel

/signature/

V. Kolodyazhni

Picture № 13

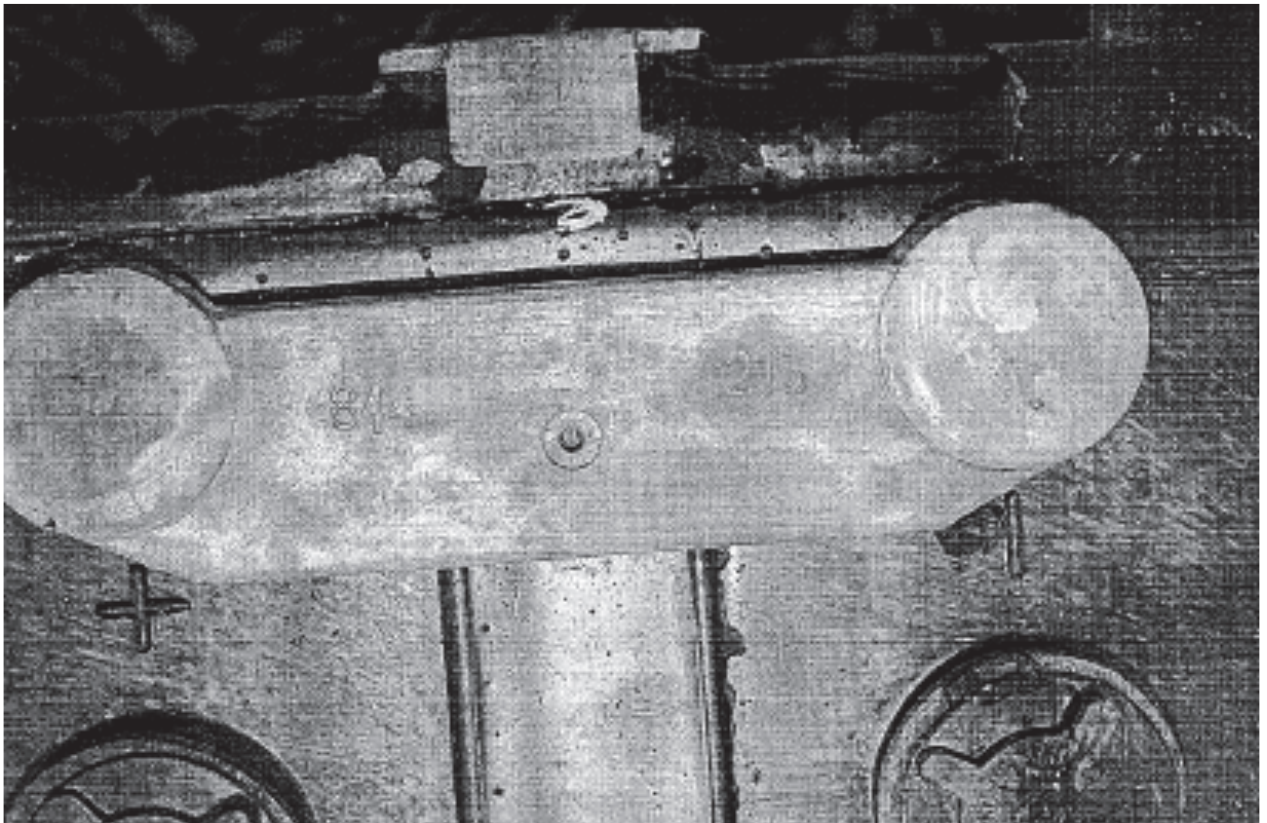

Deputy Head of operational group of military counterintelligence
of Security Service of Ukraine in sector "B"
in the anti-terrorist operation area
Colonel

/signature/

V. Kolodyazhni

Picture № 14

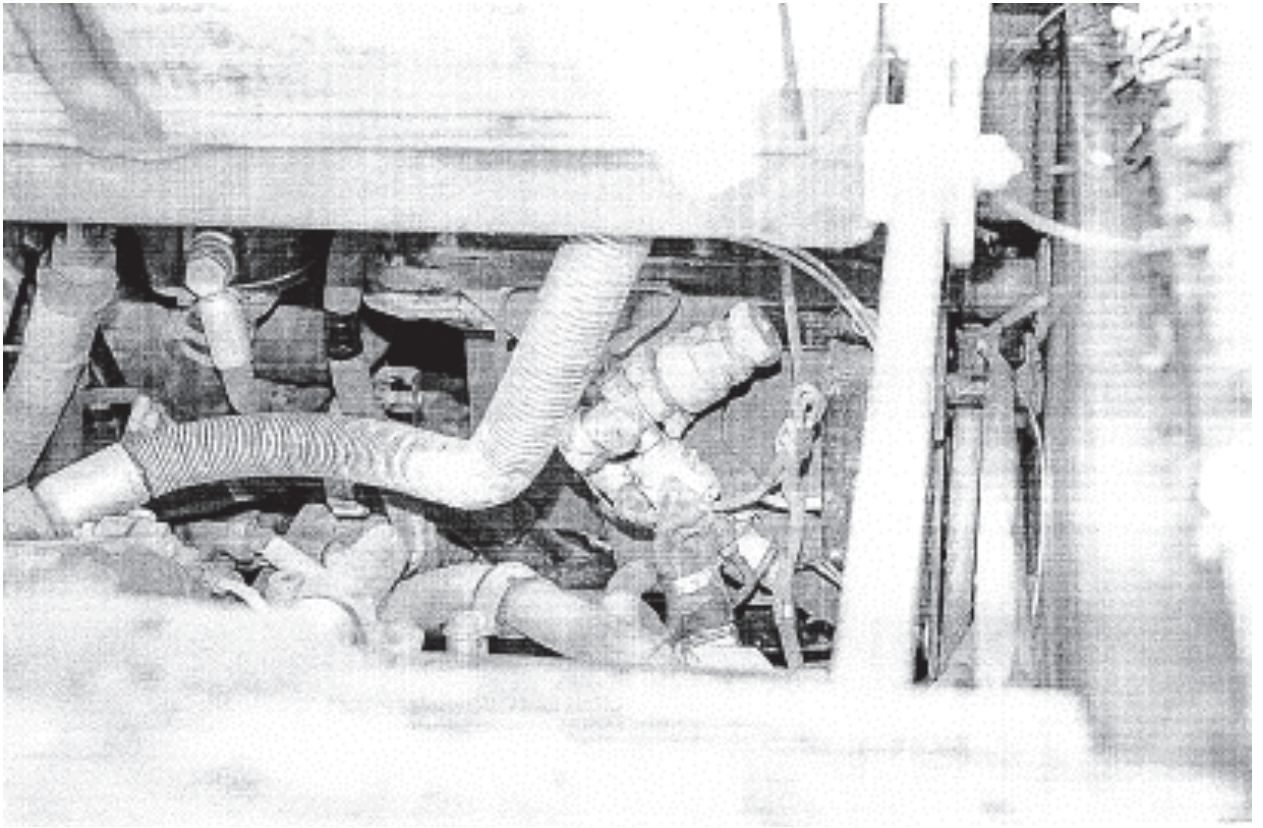

Deputy Head of operational group of military counterintelligence
of Security Service of Ukraine in sector "B"
in the anti-terrorist operation area
Colonel

/signature/

V. Kolodyazhni

Picture № 15

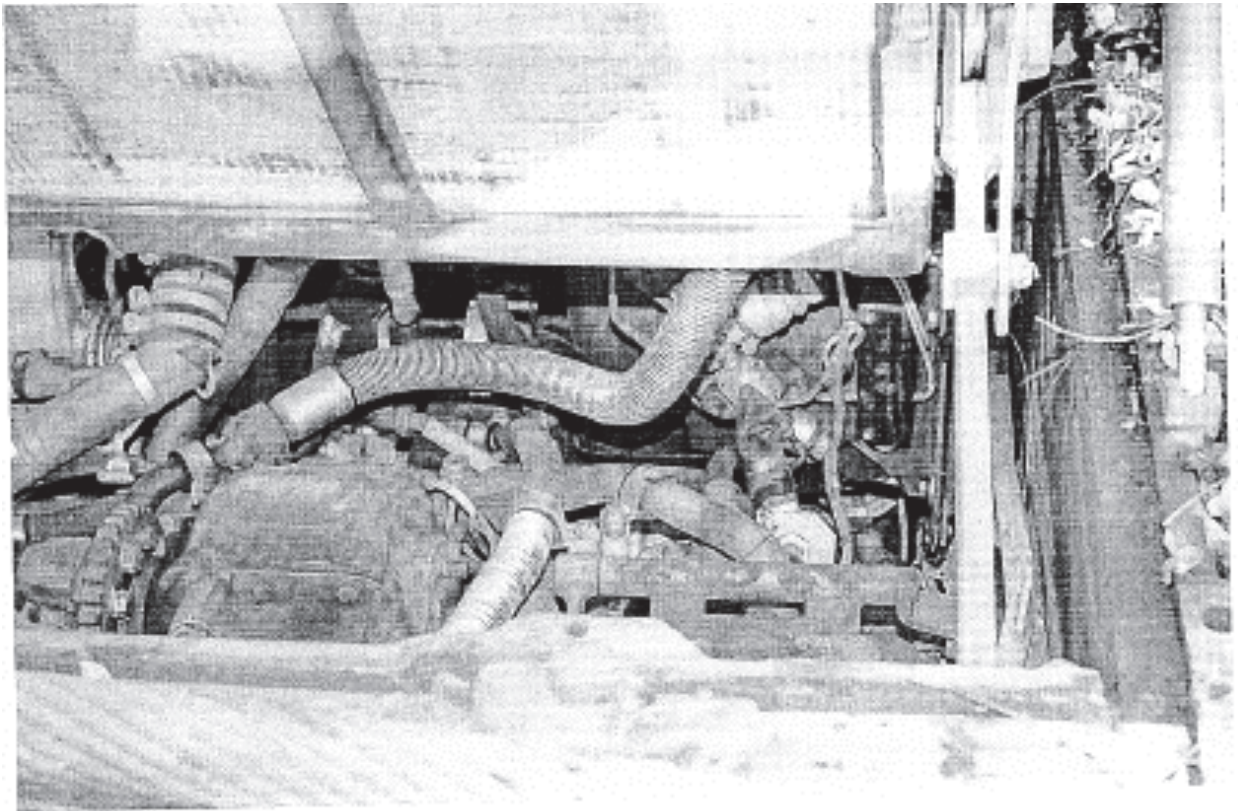

Deputy Head of operational group of military counterintelligence
of Security Service of Ukraine in sector "B"
in the anti-terrorist operation area
Colonel

/signature/

V. Kolodyazhni

Picture № 16

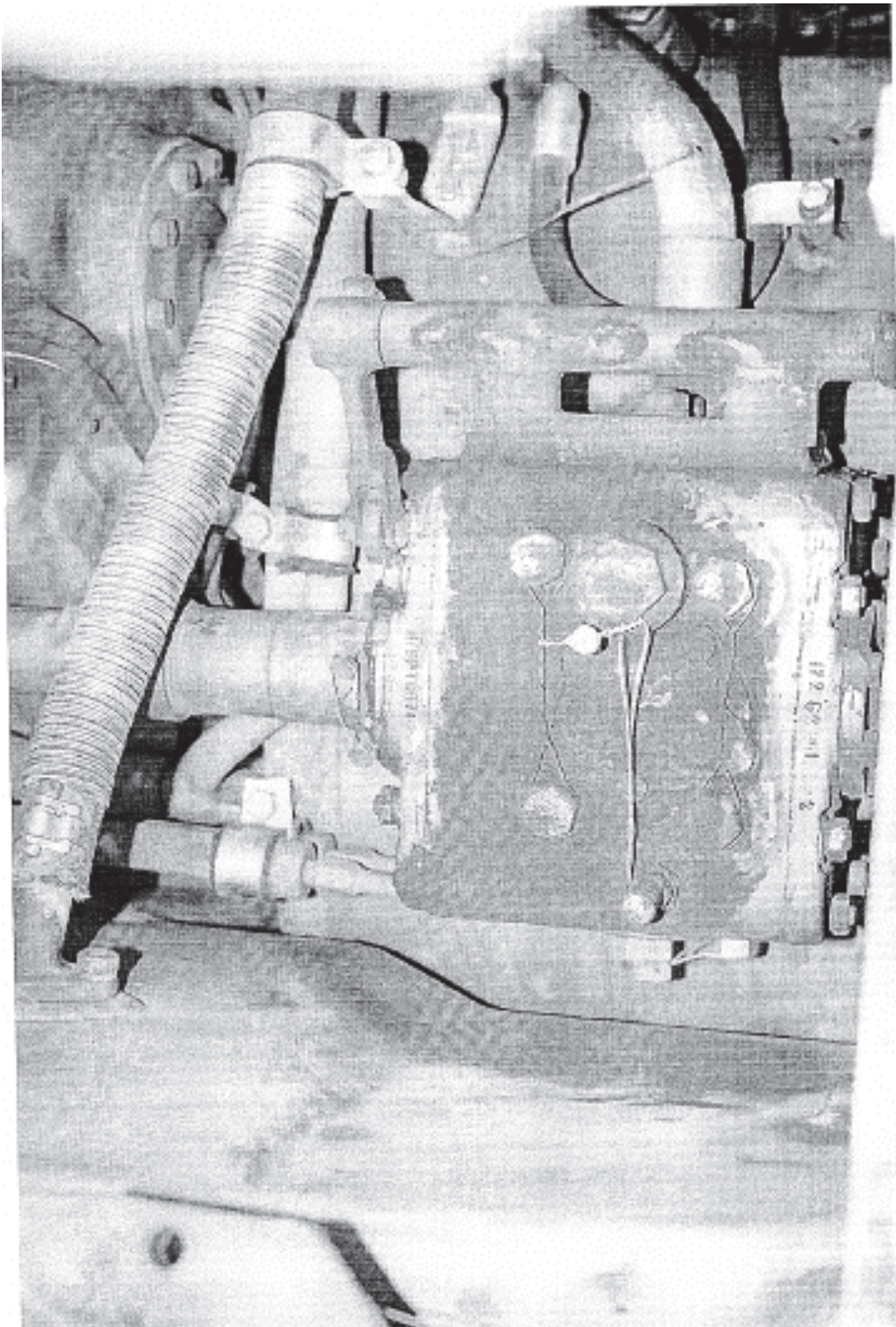

Deputy Head of operational group of military counterintelligence
of Security Service of Ukraine in sector "B"
in the anti-terrorist operation area
Colonel

/signature/

V. Kolodyazhni

Picture № 17

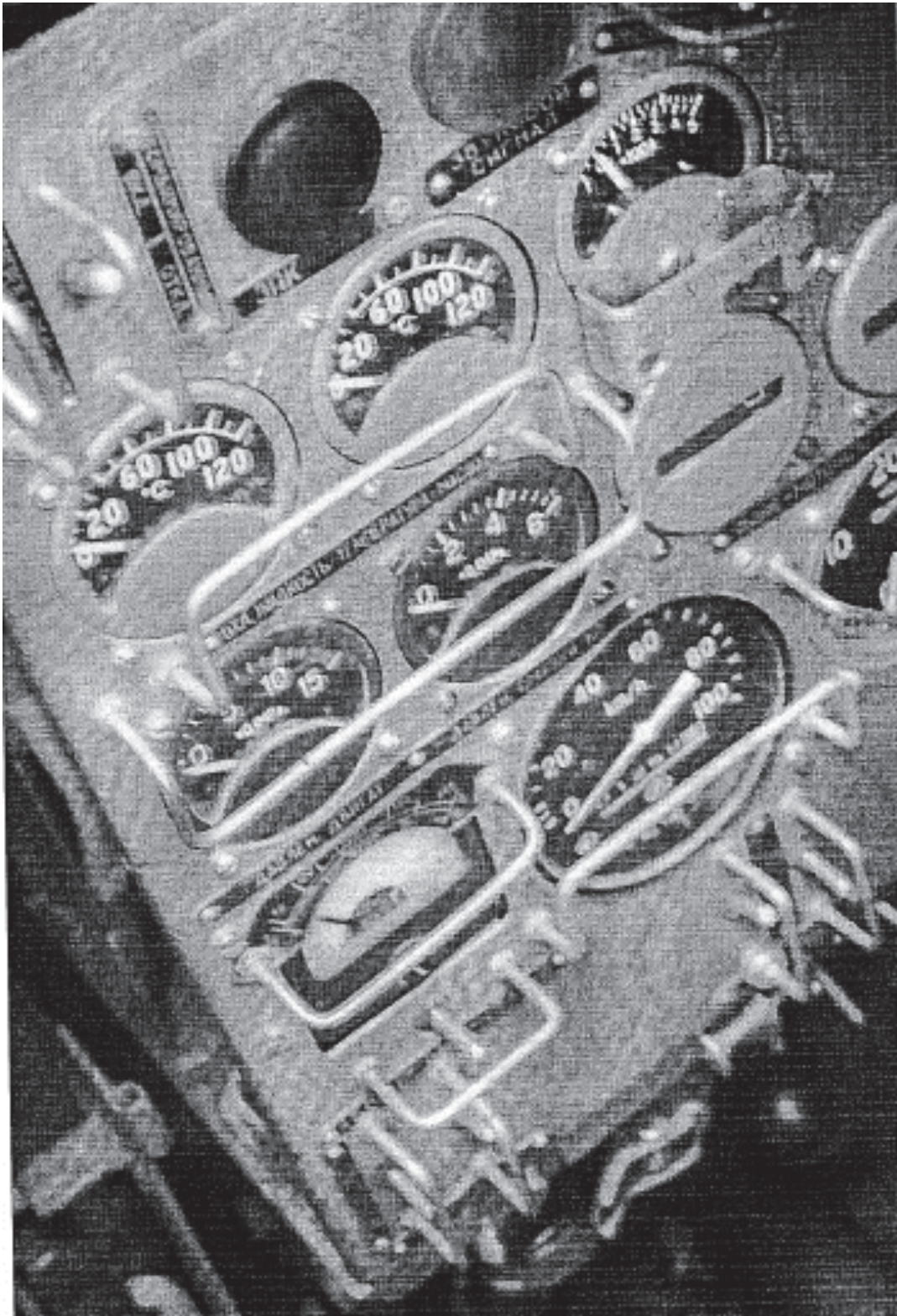

Deputy Head of operational group of military counterintelligence
of Security Service of Ukraine in sector "B"
in the anti-terrorist operation area
Colonel

/signature/

V. Kolodyazhni

Continuation sheet to the picture table of the protocol of inspection as of 27 November 2015

Picture № 18

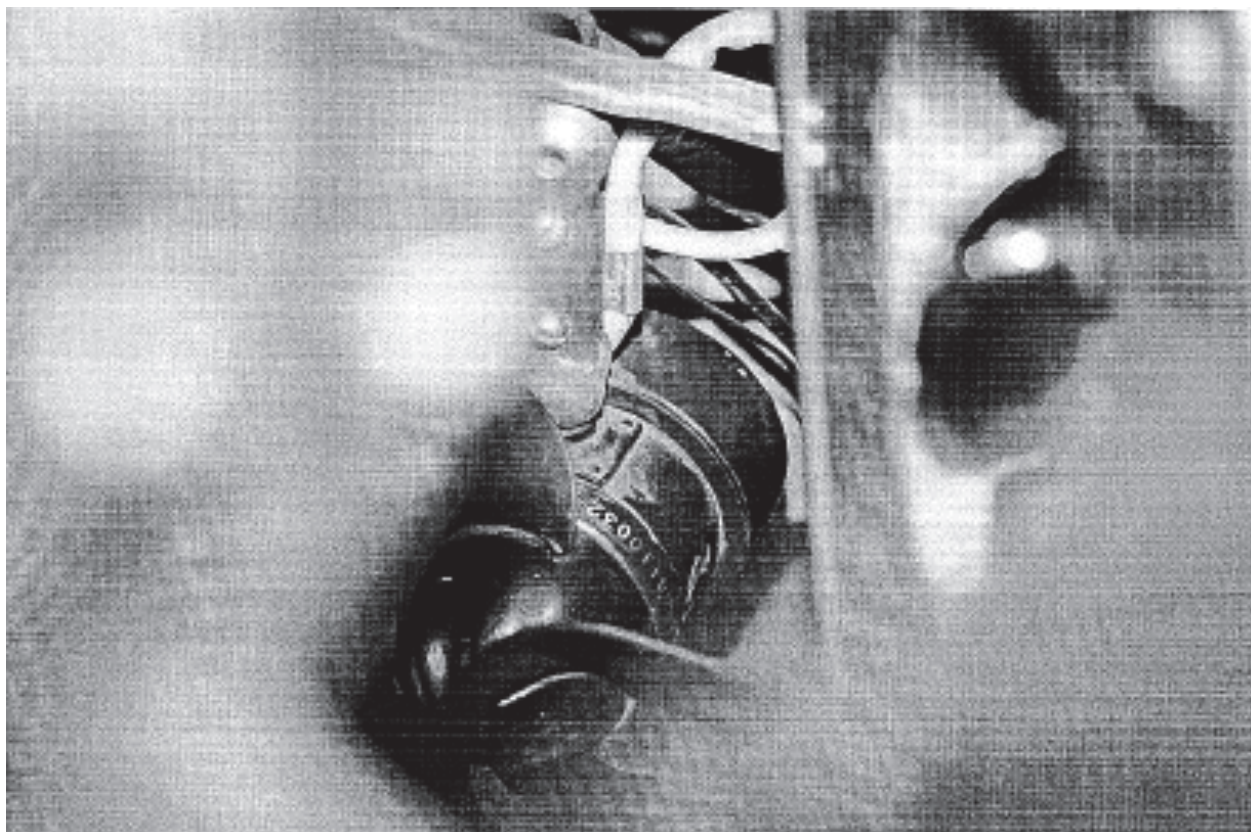

Annex 142

Executive Committee of the Kramatorsk City Council Letter No. F1-28/4812 to the
Investigations Department at the Donetsk Regional Directorate of the SBU (26
November 2015)

This document has been translated from its original language into English, an official
language of the Court, pursuant to Rules of the Court, Article 51.

Pursuant to Rules of the Court Article 51(3), Ukraine has translated only
an extract of the original document constituting this Annex. In further
compliance with this Rule, Ukraine has provided two certified copies of the
full original-language document



UKRAINE

EXECUTIVE COMMITTEE OF THE KRAMATORSK CITY COUNCIL

2 pl. Lenina, Kramatorsk, Donetsk Region 84313. Tel. (0626) 48-54-88, 48-54-91

Fax (0626)48-55-01. Email: obshotd@gov.krm.dn.ua Website: www.krm.dn.ua

12/11/2015 No. F1-28/4812

Your ref. No. 56/13/3-139 nt dated 11/26/2015

Lieutenant of Justice 1st Class S.S. Kovalyov
Senior Investigator, 3rd Section of the
Investigations Department at the Donetsk
Regional Directorate of the SBU

(deployed to Kramatorsk)

The Executive Committee of the Kramatorsk City Council has reviewed your letter No. 56/13/3-139 nt of 11/26/2015 and hereby informs you of the following:

During the artillery shelling of the city of Kramatorsk on February 10, 2015, the following residential buildings were damaged:

42 vul. Dvirtseva;
58 vul. Parkova, floors 4-6;
56 vul. Dvirtseva;
58 vul. Dvirtseva;
11 b. Kramatorskyy;
13 b. Kramatorskyy;
99 vul. Parkova;
107 vul. Parkova;
24 vul. Lenina;
34 vul. Lenina;
13 vul. Marata;
14 vul. Marata;
17 vul. Marata;
24 vul. 19 Partzyizdu;
105 vul. Parkova.

As well as the following social facilities:
Kindergarten No. 88, 23 b. Kramatorskyy;
Art School, 15 vul. Marata;
City Hospital No. 3.

By Order No. 86-r of the Cabinet of Ministers of Ukraine dated 02/12/2015, the Donetsk Regional State Administration was allocated UAH 5 million from the state budget for recovery efforts following the disaster that occurred on February 10, 2015 in the city of Kramatorsk and the provision of assistance to the victims and the families of those who were killed.

In order to resolve the procedures for the receipt and disbursement of funds, the mayor issued Order No. 10 of 02/13/2015, setting up a task force to implement measures associated with recovery efforts following the disaster that occurred in Kramatorsk on 02/10/2015 and the provision of assistance to the victims and the families of those who were killed.

Based on the task force's work and data obtained from local medical facilities and damage reports, information was identified and provided in a timely manner (on 02/16/2015) regarding the allocation of funds for measures associated with the disaster recovery

229

efforts (UAH 3,295,000 for major repairs of damaged infrastructure facilities) and the provision of assistance to the victims and the families of those who were killed (UAH 1,705,000).

Repair work was carried out on buildings, residential housing, and social infrastructure facilities that were damaged as a result of the artillery shelling.

Since the originals of the necessary documents contain a large number of pages, you may review them and make copies at the expense of the Donetsk Regional Directorate of the Security Service of Ukraine.

Mayor

[signature]

A.V. Pankov

Honcharenko 59552

Annex 143

Inspection Report of Colonel Vasyl Kolodiazhnyi, Head of Operational Group of Military Counterintelligence of the Security Service of Ukraine (23 November 2015)

This document has been translated from its original language into English, an official language of the Court, pursuant to Rules of the Court, Article 51.

Pursuant to Rules of the Court Article 51(3), Ukraine has translated only an extract of the original document constituting this Annex. In further compliance with this Rule, Ukraine has provided two certified copies of the full original-language document

Inspection report

Donetsk region
Yasynuvata district
Progress village

November 27, 2015
inspection commenced at 10.30 am
inspection completed at 12.00 am

Colonel Vasyl Vasyliovych Kolodiazhnyi, the Deputy Head of operational group of military counterintelligence of Security Service of Ukraine in “Б” sector in the anti-terrorist operation area with the participation of the following experts: tank gunner of the 3rd platoon, 3rd military unit, 2nd separate tank battalion (military unit B1193) soldier Oleksandr Mykhailovych Pavlov and machine operator of the 3rd platoon, 3rd military unit, 2nd separate tank battalion (military unit B1193), sergeant Ivan Volodymyrovych Chaikovsky, based on Cl. 25 of the Law of Ukraine “About the Security Service of Ukraine”, cl. 8 of the Law of Ukraine “About criminal investigation”, cl. 15 of the Law of Ukraine “About counter-terrorism”, has examined tank of T-72 type, located in the wood line near Progress village of Yasynuvata district of Donetsk oblast.

During this inspection, pictures were taken by means of “iPhone” device.

The inspection showed:

There is a tank of T-72 type of dark-green color in the wood line near Progress village of Yasynuvata district of Donetsk oblast.

The front part of the hull, as well as lateral protection parts of caterpillars, are equipped with explosive-reactive armor means in the form of metal boxes.

During visual inspection of the tank, it was found that the protective metal parts of caterpillars and front parts of the hull have such damages as dents, nicks and metal ruptures.

In the course of inspection, pictures of tank were taken and pictures of all its sides were attached to this report as **Annexes No 1 - 4**.

Then, during inspection, it was found that the tank has alphanumeric designations as the following:

- embossed alphanumeric tank serial number: “И04BT8149” on the front hull (this designation is pictured and the picture is added to this report as **annex No5**);
- embossed alphanumeric designation “2A46CB01-2 NA1155” on the tank gun barrel (this designation is pictured and the picture is added to this report as **annex No6**);
- embossed alphanumeric designation “Д11BT1924” on the tank fighting compartment (this designation is pictured and the picture is added to this report as **annex No7**);

continuation of inspection report dated 23.11.2015

- "6БЛТ184" designation of tank sight number at the gunner's station (this designation is pictured and the picture is added to the report as **annex No 8**);
- "N1АДИ662" designation of tank rangefinder at the gunner's station (this designation is pictured and the picture is added to the report as **annex No 9**);
- "И12РТ0871" designation on the transfer case of the right gear box in the engine compartment;
- "X01РТ5014" designation on the transfer case of the left gear box in the engine compartment;
- The tank-driver cabin contains 4 units of batteries of 6СТ-140ТМ type, with manufacturer's label, containing the following information: "Electrotiaga" Closed Joint-Stock Company". Accumulator starting battery 6СТ-140ТМ. ТУ 16-529.357-78. Russian Federation, 198095, city of St. Petersburg, 50А, Kalinina str., tel. (812) 7863244, (812) 7862889, fax: (812) 7864739. The warranty period - 3 years". One of the terminals in the upper battery part contains embossed numerical designation "844" and "1213", which is the battery number and the manufacture date – December of year 2013 (these designations are pictured and the pictures are added to the report as **annexes No 10-13**).

At that, the both specialists, Pavlov O. M. and Chaikovsky I.V. assured that the inspected tank was of T-72 Б 1 modification being armed with Russian Armed Forces and besides, they pointed out the distinctive features of the above mentioned fighting vehicle in comparison with tanks of T-72 type being armed with Ukrainian Armed Forces, that is:

- on the inspected tank, the air valve "ИЛ" is arranged in the transmission compartment, while in the Ukrainian tanks, it is in the fighting compartment (in the turret), (the picture is attached to this report as **Annexes No 14, 15**)

- factory seal is available on all units, assemblies of this tank (Ukrainian tanks of T-72 type were overhauled at the armored factories (in Lviv and Kyiv) and therefore they cannot have the manufacturer's factory seal), (the picture is attached to this report as **Annex No16**);

- the inspected tank has an hour meter under load (such hour meter under load is not installed in Ukrainian tanks), (the picture is attached to this report as **Annex No 17**);

- fans of "ДВ-3" type are at the crew stations (after overhaul, the Ukrainian tanks have fans of foreign production (mostly of China)), (the picture is attached to this report as **Annex No 18**);

continuation of inspection report dated 23.11.2015

- the inspected tank has the fuel heating system (in tanks of T-72 type being armed with Ukrainian Armed Forces, such system was removed during overhaul).

The pictures are attached to this inspection report as Annexes No 1-18, total 18 sheets, and they are also recorded on the CD-R disc which is also attached to this report.

Experts: _____

Inspection was conducted and report was drawn up by:

**Deputy Head of operational group of military counterintelligence
of Security Service of Ukraine in "B" sector
in the anti-terrorist operation area
Colonel**

V. Kolodyazhni

27.11.2015

Picture table

To the protocol of inspection of tank T-72B1 №И04BT8149 as of 27 November 2015 (Annexes №1 - №18)

Picture № 1



Deputy Head of operational group of military counterintelligence
of Security Service of Ukraine in sector “B”
in the anti-terrorist operation area
Colonel

/signature/

V. Kolodyazhni

Picture № 2



Deputy Head of operational group of military counterintelligence
of Security Service of Ukraine in sector "B"
in the anti-terrorist operation area
Colonel

/signature/

V. Kolodyazhni

Continuation sheet to the picture table of the protocol of inspection as of 27 November 2015

Picture № 3



Deputy Head of operational group of military counterintelligence
of Security Service of Ukraine in sector “B”
in the anti-terrorist operation area
Colonel

/signature/

V. Kolodyazhni

Picture № 4



Deputy Head of operational group of military counterintelligence
of Security Service of Ukraine in sector "B"
in the anti-terrorist operation area
Colonel

/signature/

V. Kolodyazhni

Picture № 5



Deputy Head of operational group of military counterintelligence
of Security Service of Ukraine in sector "B"
in the anti-terrorist operation area
Colonel

/signature/

V. Kolodyazhni

Picture № 6



Deputy Head of operational group of military counterintelligence
of Security Service of Ukraine in sector "B"
in the anti-terrorist operation area
Colonel

/signature/

V. Kolodyazhni

Picture № 7



Deputy Head of operational group of military counterintelligence
of Security Service of Ukraine in sector "B"
in the anti-terrorist operation area
Colonel

/signature/

V. Kolodyazhni

Picture № 8



Deputy Head of operational group of military counterintelligence
of Security Service of Ukraine in sector "B"
in the anti-terrorist operation area
Colonel

/signature/

V. Kolodyazhni

Picture № 9



Deputy Head of operational group of military counterintelligence
of Security Service of Ukraine in sector "B"
in the anti-terrorist operation area
Colonel

/signature/

V. Kolodyazhni

Picture № 10



Deputy Head of operational group of military counterintelligence
of Security Service of Ukraine in sector "B"
in the anti-terrorist operation area
Colonel

/signature/

V. Kolodyazhni

Picture № 11



Deputy Head of operational group of military counterintelligence
of Security Service of Ukraine in sector "B"
in the anti-terrorist operation area
Colonel

/signature/

V. Kolodyazhni

Picture № 12



Deputy Head of operational group of military counterintelligence
of Security Service of Ukraine in sector "B"
in the anti-terrorist operation area
Colonel

/signature/

V. Kolodyazhni

Picture № 13



Deputy Head of operational group of military counterintelligence
of Security Service of Ukraine in sector "B"
in the anti-terrorist operation area
Colonel

/signature/

V. Kolodyazhni

Picture № 14



Deputy Head of operational group of military counterintelligence
of Security Service of Ukraine in sector "B"
in the anti-terrorist operation area
Colonel

/signature/

V. Kolodyazhni

Picture № 15



Deputy Head of operational group of military counterintelligence
of Security Service of Ukraine in sector "B"
in the anti-terrorist operation area
Colonel

/signature/

V. Kolodyazhni

Picture № 16

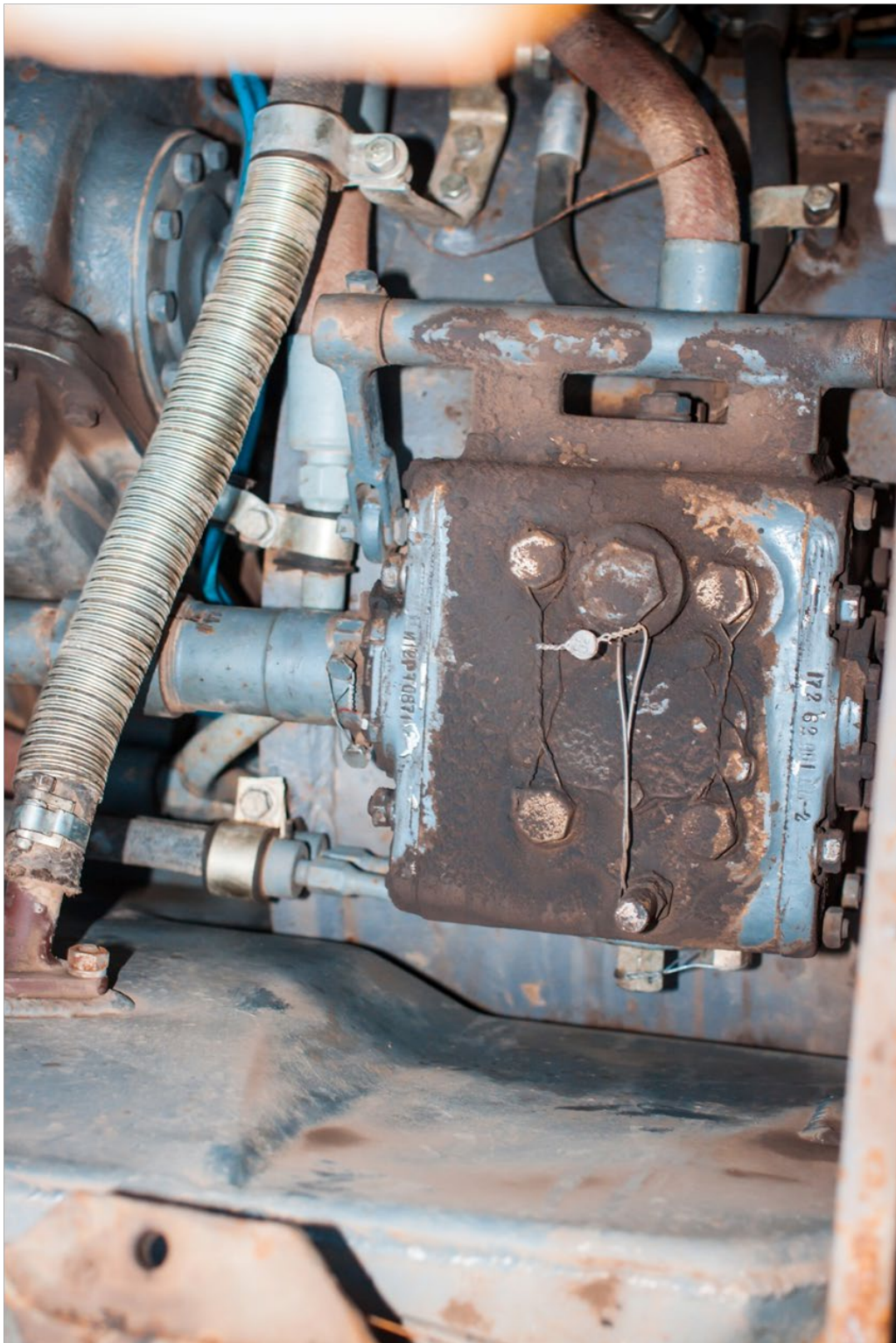

Deputy Head of operational group of military counterintelligence
of Security Service of Ukraine in sector "B"
in the anti-terrorist operation area
Colonel

/signature/

V. Kolodyazhni

Picture № 17



Deputy Head of operational group of military counterintelligence
of Security Service of Ukraine in sector "B"
in the anti-terrorist operation area
Colonel

/signature/

V. Kolodyazhni

Continuation sheet to the picture table of the protocol of inspection as of 27 November 2015

Picture № 18

